



# ALLIED MACHINE & ENGINEERING

Holemaking Solutions for Today's Manufacturing



Boring



Reaming



Burnishing



Threading



Specials



## T-A<sup>®</sup> Drilling System

► *DRILLING*

Replaceable Insert Drilling System

## North America

**Allied Machine**  
120 Deeds Drive  
Dover, OH 44622  
United States

**Allied Machine**  
485 West 3rd Street  
Dover, OH 44622  
United States

### ThreadMills USA™

4185 Crosstowne Ct #B  
Evans, GA 30809  
United States

### Superion®

1285 S Patton St.  
Xenia, OH 45385  
United States

## Europe

**Allied Machine Europe**  
93 Vantage Point  
Pensnett Estate  
Kingswinford  
West Midlands  
DY6 7FR, United Kingdom

### Wohlhaupter® GmbH

Maybachstrasse 4  
Postfach 1264  
72636 Frickenhausen  
Germany

## Asia

**Wohlhaupter® India**  
B-23, 3rd Floor  
B Block Community Centre  
Janakpuri, New Delhi - 110058  
India



Allied Machine & Engineering is a worldwide leader in holemaking and finishing solutions. We are committed to providing practical and dependable solutions to our customers through innovative designs and superior customer and technical support.

We continue to expand our product offering in order to provide new and different solutions. With Field Sales Engineers located around the world, we position ourselves to provide technical support on site, right at your spindle.



**ALLIED MACHINE**  
**& ENGINEERING**

[www.alliedmachine.com](http://www.alliedmachine.com)



# ALLIED MACHINE & ENGINEERING

Holemaking Solutions for Today's Manufacturing

## T-A® Drilling System

### The Foundation

Since 1941, Allied Machine & Engineering has provided dependable and practical holemaking solutions to the world. What was once a small job shop in Ohio is now a worldwide leader in cutting tool technology. With three manufacturing facilities in Ohio, one in Georgia, another in Germany, and headquarters in both the United States and Europe, Allied Machine is positioned to bring innovative solutions and technical expertise directly to the customers' hands.



### The Beginning

Harold E. Stokey founded Allied Machine & Engineering to aid the war effort, manufacturing taper bearing lock nuts for the production of M1 tanks. Years later, after a sales meeting gone wrong, Stokey possessed a warehouse stocked with spade drill inserts. He set forth into the industry that would become Allied Machine's thriving identity: holemaking.



### The T-A®

When Harold's son, William H. Stokey, became the president and CEO, he developed the Throw Away, or T-A, spade drill insert system. The T-A revolutionized the holemaking industry, launching Allied Machine ahead of the competition. Since then, numerous innovations and advancements have been created from the T-A's inspiration.



### The Innovation

Since the development of the T-A, Allied Machine has expanded its product offering to support a vast range of customer applications, including large diameter and deep hole drilling, boring, reaming, burnishing, porting, and threading.

### The People

Allied Machine understands that high-quality products are only one facet of success. Our customer support is crucial to what we do, and that's why we make sure the best engineers and customer service associates are in place to assist our customers around the world.

### The Future

With over 75 years of experience, Allied Machine has encountered the challenges of growth and success. By investing in cutting edge technology and the brightest and sharpest minds, our knowledge and capabilities continue to expand and grow every day.



**Steve Stokey**  
Executive Vice President

**William H. Stokey**  
President and CEO

**Mike Stokey**  
Executive Vice President



## Product Offering Overview



### DRILLING

The highest performance cutting tools to cover the largest range of drilling applications.

- Replaceable Insert Drills:
  - T-A Pro® | T-A® | GEN2 T-A®
  - GEN3SYS® XT Pro | GEN3SYS® XT
  - High Performance | Universal
- Indexable Insert Drills:
  - 4TEX® Drill
  - Revolution Drill®
  - Opening Drill®
  - APX™ Drill
- Solid Carbide Drills:
  - Superion®
- Hydraulic Port Contour Cutters:
  - AccuPort 432®
- BTA (STS) Machining Solutions:
  - BT-A Drill
- Structural Steel Solutions:
  - T-A® | GEN2 T-A®
  - GEN3SYS® XT Pro



### BORING



All your hole finishing applications can be conquered with the Wohlhaupter® and Criterion® product lines.

- Wohlhaupter:
  - Ideal for applications involving high production, extreme tolerances, and expensive parts
- Criterion:
  - Perfect for manufacturers looking for a versatile modular boring system to cover a wide range of applications.

**WOHLHAUPTER®**  
**CRITERION®**



## REAMING

ALVAN® reamers by S.C.A.M.I. provide excellent hole finishes and hold tight tolerances to ensure processes are performed to accurate specifications.

- Products:
  - Replaceable head style
  - Monobloc style
  - Cutting ring style

**S.C.A.M.I.®**



**S.C.A.M.I.®**



## BURNISHING

S.C.A.M.I.® roller burnishing tools produce excellent surface finishes and increase surface hardness.

- Products:
  - Blind hole burnishers
  - Through hole burnishers



## THREADING

Achieve precise thread forms with a large variety of thread mills through the ThreadMills USA™ and AccuThread® product lines.

- Products:
  - ThreadMills USA™ solid carbide
  - AccuThread® 856
  - AccuThread® T3
  - AccuThread® 856: Bolt-in Style
  - AccuThread® 856: Pin Style



## SPECIALS



If your application can't be satisfied with standard tooling, Allied can special engineer any product for your solution.

- Products:
  - Superion® solid carbide and PCD tools
  - Allied Machine and Wohlhaupter® engineered specials



SECTION

---

# A30

---

T-A® Drilling System

# T-A<sup>®</sup> Drilling System

Replaceable Insert Drilling System | GEN2 T-A<sup>®</sup> | T-A<sup>®</sup>

► Diameter Range: 0.374" - 4.507" (9.50 mm - 114.48 mm)



## This is Not Yesterday's Spade Drill

The T-A drilling system is an innovation inspired by the Universal replaceable spade insert drilling system. However, with the development of the GEN2 T-A insert, along with the countless geometry options for the T-A, this drilling system provides benefits and performance that spade blade inserts of the past never could.

With constant innovations in holder designs, insert geometries and coatings, and coolant dispersion, the T-A drilling system continues to evolve and become much more productive and powerful than ever before.

Your safety and the safety of others is very important. This catalog contains important safety messages. Always read and follow all safety precautions.



This triangle is a safety hazard symbol. It alerts you to potential safety hazards that can cause tool failure and serious injury.

When you see this symbol in the catalog, look for a related safety message that may be near this triangle or referred to in the nearby text.

There are safety signal words also used in the catalog. Safety messages follow these words.

### **WARNING**

**WARNING** (shown above) means that failure to follow the precautions in this message could result in tool failure and serious injury.

**NOTICE** means that failure to follow the precautions in this message could result in damage to the tool or machine but not result in personal injury.

**NOTE** and **IMPORTANT** are also used. These are important that you read and follow but are not safety-related.

Visit [www.alliedmachine.com](http://www.alliedmachine.com) for the most up-to-date information and procedures.

Excellent hole size and finish	Optimizes chip evacuation	Wide range of geometry options available
--------------------------------	---------------------------	--

## Applicable Industries



Aerospace



Agriculture



Automotive



Firearms



General Machining



Oil & Gas



Renewable Energy



**Reference Icons**

The following icons will appear throughout the catalog to help you navigate between products.

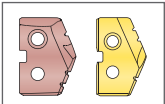

**T-A Inserts**

Refers to the range of inserts that connect with the corresponding holders

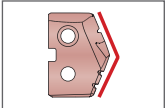

**Available Insert Geometries**

Details for the different geometry options available for each T-A insert style

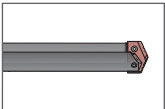

**T-A Holders**

Refers to the range of holders that connect with the corresponding inserts

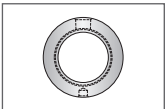

**Rotary Coolant Adapter (RCA) Information**

Detailed instructions and information regarding the corresponding part(s)



**T-ACR 45 Chamfer Rings**

Refers to the range of T-ACR 45 chamfer rings available for the corresponding holders



**Technical Information**

Detailed instructions and information regarding the corresponding part(s)

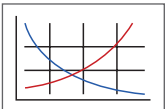

**Recommended Cutting Data**

Speed and feed recommendations for optimum and safe drilling



**Coolant-Through Option**

Indicates that the product is coolant through

Series	Diameter Range	
	Imperial (inch)	Metric (mm)
Y	0.374 - 0.436	9.50 - 11.07
Z	0.437 - 0.510	11.10 - 12.95
0	0.511 - 0.695	12.98 - 17.65
1	0.690 - 0.960	17.53 - 24.38
2	0.961 - 1.380	24.41 - 35.05
3	1.353 - 1.882	34.36 - 47.80
4	1.850 - 2.570	46.99 - 65.28
5	2.456 - 3.000	62.38 - 76.20
6	3.001 - 3.507	76.22 - 89.08
7	3.508 - 4.000	89.10 - 101.60
8	4.001 - 4.507	101.63 - 114.48

**Introduction Information**

T-A Inserts Overview . . . . . 2 - 3  
 T-A Insert Geometries . . . . . 4 - 6  
 T-A Holders Overview . . . . . 7  
 Technical Information . . . . . 8 - 9  
 Product Nomenclature . . . . . 10 - 11

**T-A Drill Series**

Y Series . . . . . 12 - 21  
 Z Series . . . . . 22 - 31  
 0 Series . . . . . 32 - 43  
 1 Series . . . . . 44 - 57  
 2 Series . . . . . 58 - 73  
 3 Series . . . . . 74 - 85  
 4 Series . . . . . 86 - 93  
 5 and 6 Series . . . . . 94 - 101  
 7 and 8 Series . . . . . 102 - 109

**T-A Drill Adapters**

Rotary Coolant Adapters (RCA) . . . . . 110  
 T-ACR 45 Chamfer Rings . . . . . 111















**Recommended Cutting Data**

Imperial (inch)	GEN2 T-A® . . . . . 112 - 115
	T-A . . . . . 116 - 119
	Flat Bottom Geometry . . . . . 120 - 123
	Diamond Coating . . . . . 124
	Tap Drill Information . . . . . 125
	Coolant Recommendations . . . . . 126 - 127
	GEN2 T-A . . . . . 128 - 131
	T-A . . . . . 132 - 135
	Flat Bottom Geometry . . . . . 136 - 139
	Diamond Coating . . . . . 140
	Tap Drill Information . . . . . 141
	Coolant Recommendations . . . . . 142 - 143















**Troubleshooting Guide . . . . . 144 - 145**

**Deep Hole Drilling Guidelines . . . . . 146**





T-A Drilling System Overview | Drill Inserts

Series	Y Series	Z Series	0 Series	1 Series	2 Series	3 Series	4 Series
GEN2 T-A®							
D <sub>1</sub> inch	0.374 - 0.436	0.437 - 0.510	0.511 - 0.695	0.690 - 0.960	0.961 - 1.380	1.353 - 1.882	1.850 - 2.570
D <sub>1</sub> mm	9.50 - 11.07	11.10 - 12.95	12.98 - 17.65	17.53 - 24.38	24.41 - 35.05	34.36 - 47.80	46.99 - 65.28
Half Series Option*							
HSS Substrates	Super Cobalt	Super Cobalt	Super Cobalt	Super Cobalt	Super Cobalt	HSS Super Cobalt Premium Cobalt	HSS Super Cobalt
Carbide Substrates	C1 (K35) C2 (K20)	C1 (K35) C2 (K20)	C1 (K35) C2 (K20)	C1 (K35) C2 (K20)	C1 (K35) C2 (K20)	-	-
Coatings	AM200® AM300®	AM200® AM300®	AM200® AM300®	AM200® AM300®	AM200® AM300®	AM200® TiN	AM200® TiN









\*See page A30: 7 for more information regarding half series options









Series	Y Series	Z Series	0 Series	1 Series	2 Series	3 Series	4 Series
T-A®							
D <sub>1</sub> inch	0.374 - 0.436	0.437 - 0.510	0.511 - 0.695	0.690 - 0.960	0.961 - 1.380	1.353 - 1.882	1.850 - 2.570
D <sub>1</sub> mm	9.50 - 11.07	11.10 - 12.95	12.98 - 17.65	17.53 - 24.38	24.41 - 35.05	34.36 - 47.80	46.99 - 65.28
Half Series Option*							
HSS Substrates	Super Cobalt Premium Cobalt	Super Cobalt Premium Cobalt	Super Cobalt Premium Cobalt	HSS Super Cobalt Premium Cobalt	HSS Super Cobalt Premium Cobalt	Super Cobalt	Super Cobalt
Carbide Substrates	C2 (K20) C3 (K10) C5 (P40) N2	C2 (K20) C3 (K10) C5 (P40) N2	C2 (K20) C3 (K10) C5 (P40) N2	C2 (K20) C3 (K10) C5 (P40) N2	C2 (K20) C3 (K10) C5 (P40) N2	C2 (K20) C5 (P40)	-
Coatings	TiN TiAlN TiCN	TiN TiAlN TiCN	TiN TiAlN TiCN	TiN TiAlN TiCN	TiN TiAlN TiCN	TiN	TiN

\*See page A30: 7 for more information regarding half series options

Drill Insert Coatings				
				
<p><b>AM300®</b></p> <ul style="list-style-type: none"> <li>Increased heat resistance over AM200® coating</li> <li>Up to 20% increased tool life over AM200 coating</li> <li>Provides superior tool life at high penetration rates</li> <li>Color: copper/orange</li> </ul>	<p><b>AM200®</b></p> <ul style="list-style-type: none"> <li>First choice for increased heat resistance over TiN, TiCN, and TiAlN with improved wear capabilities</li> <li>Allows for improved tool life and higher penetration rates</li> <li>Over 20% increase in tool life compared to TiAlN coating</li> <li>Color: copper/bronze</li> </ul>	<p><b>TiN</b></p> <ul style="list-style-type: none"> <li>General purpose coating</li> <li>Improved tool life over non-coated inserts</li> <li>Excellent choice for aluminum</li> <li>Color: gold/yellow</li> </ul>	<p><b>TiAlN</b></p> <ul style="list-style-type: none"> <li>Excellent choice for wear resistance over high surface speeds</li> <li>Excellent oxidation resistance</li> <li>Maximum working temperature 800°C</li> <li>Color: violet/grey</li> </ul>	<p><b>TiCN</b></p> <ul style="list-style-type: none"> <li>Excellent choice for wear resistance over low surface speeds</li> <li>High hardness/wear resistance</li> <li>Maximum working temperature 400°C</li> <li>Color: blue/grey</li> </ul>

A  
DRILLING  
B  
BORING  
C  
REAMING  
D  
URNISHING  
E  
HREADING  
X  
PECIALS

5 Series	6 Series	7 Series	8 Series
			
2.456 - 3.000	3.001 - 3.507	3.508 - 4.000	4.001 - 4.507
62.38 - 76.20	76.22 - 89.08	89.10 - 101.60	101.63 - 114.48
			
HSS Super Cobalt	HSS Super Cobalt	HSS Super Cobalt	HSS Super Cobalt
-	-	-	-
AM200® TiN	AM200® TiN	AM200® TiN	AM200® TiN

5 Series	6 Series	7 Series	8 Series
			
2.456 - 3.000	3.001 - 3.507	3.508 - 4.000	4.001 - 4.507
62.38 - 76.20	76.22 - 89.08	89.10 - 101.60	101.63 - 114.48
			
HSS Super Cobalt	HSS Super Cobalt	HSS Super Cobalt	HSS Super Cobalt
-	-	-	-
TiN	TiN	TiN	TiN

Drill Insert Grades			
<p><b>HSS (T-A® / GEN2 T-A®)</b></p> <p>First choice for general purpose use. Suited for difficult machining applications with low rigidity, as well as deep hole drilling. Recommended for drilling most steels, cast irons, and aluminum alloys up to 275 BHN.</p>	<p><b>HSS Super Cobalt (T-A® / GEN2 T-A®)</b></p> <p>Suited for good-to-rigid machining applications, used for drilling exotic and high-alloy materials, or general use when surface speed needs to be increased. For use in material hardness up to 350 BHN.</p>	<p><b>HSS Premium Cobalt (T-A® / GEN2 T-A®)</b></p> <p>Suited for rigid machining applications, used for drilling exotic and high alloy materials, or general use when surface speed needs to be increased. For material hardness up to 400 BHN.</p>	<p><b>Carbide C5 (P40) (T-A®)</b></p> <p>Excellent for drilling free-machining steel, low/medium-carbon steels, alloy steels, high-strength steels, tool steels, and hardened steels.</p>
<p><b>Carbide C3 (K10) (T-A®)</b></p> <p>Designed for drilling grey/white cast irons. The special geometry offers substantial increase in penetration rates and provides exceptional edge strength and tool life.</p>	<p><b>Carbide C2 (K20) (T-A® / GEN2 T-A®)</b></p> <p>Excellent for drilling high-temperature alloys, titanium alloys, cast aluminum, SG/nodular cast iron, grey/white iron, aluminum bronze, brass, copper, and certain stainless steels.</p>	<p><b>Carbide C1 (K35) (T-A® / GEN2 T-A®)</b></p> <p>Excellent for drilling free-machining steels, low/medium-carbon steels, alloy steels, high -strength steels, tool steels, and hardened steels.</p>	<p><b>Carbide N2 (T-A®)</b></p> <p>Allied's N2 carbide is used with CVD diamond coating. This improves the insert's hardness, durability, and performance, which extends tool life between 30 - 50x over uncoated carbide.</p>

## Insert Geometries

### There's a Geometry for That

Allied Machine knows there isn't a one-size-fits-all solution when it comes to holemaking. To better accommodate the countless holes our customers drill, we have developed multiple geometry options with new geometries in development at all times.

If you're unsure which geometry would be best for your application, give our Application Engineers a call. They're standing by ready to point you in the right direction.

☎ 1.330.343.4283

☎ 1.800.321.5537 (toll free United States and Canada)

✉ [appeng@alliedmachine.com](mailto:appeng@alliedmachine.com)

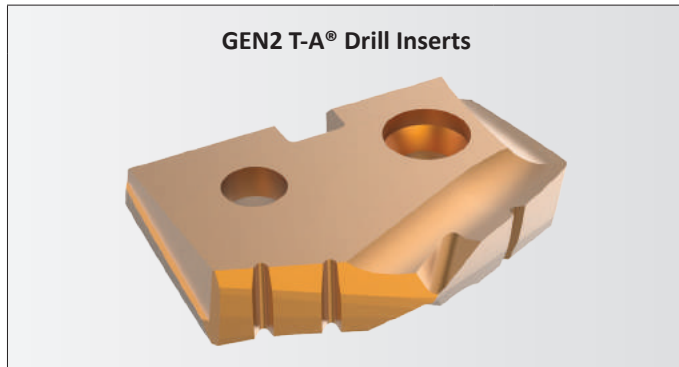
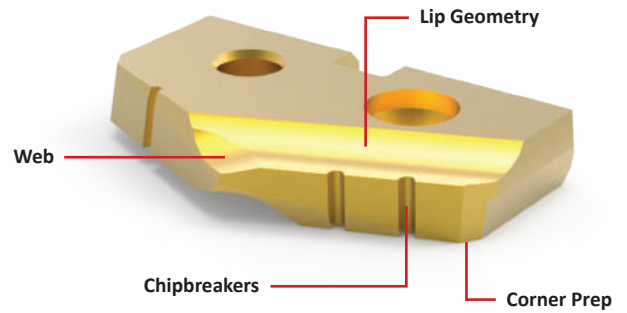

**GEN2 T-A® Drill Inserts**



**T-A® Drill Inserts**

#### Standard

- Offers substantial increases in penetration rates and tool life
- Improves centering, drill stability, chip formation, and lowers drill forces
- Provides smoother breakout on through hole applications



#### Standard

- Offers excellent penetration rates and tool life
- Smooth break-out on through holes
- Increases drill stability and chip formation
- Ideally suited for low-to-high rigidity machining applications

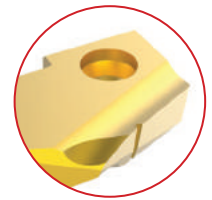

#### High Efficiency (-HE)

- Excellent chip formation in materials with very high elasticity/ductility and poor chip forming conditions
- Effective in lower-powered machines
- Material example: low-carbon steel (not suitable for stainless steel)

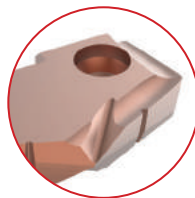

#### Tiny Chip (-TC)

- Unique lip and point design for excellent chip control
- Improved capabilities in long-chipping materials such as low-carbon steels and soft alloy steels
- Enhanced performance in lower-powered machines for better chip formation at lower feed rates



#### Corner Radius (-CR)

- Improves exit burrs
- Excellent surface finish in most applications
- Improves heat dispersion and tool life
- Can be used in addition to other geometries (as a special)

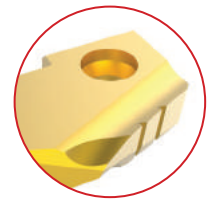

#### Special Corner Preparation (-SK)

- Ideal for machining cast iron materials
- Larger than a standard corner clip
- Improves heat resistance
- Standard feature on CI, HI, and HR geometries

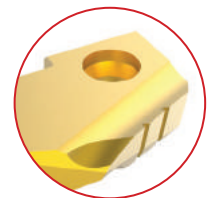

continued on next page

**Cam Point (-CP)**

- Helical cam ground point
- Improves drill stability and centering characteristics
- Reduces bellmouthing when using longer holders
- Target materials: steels, cast/forged steels, cast iron

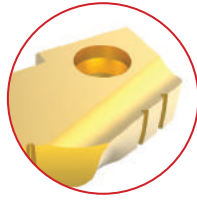

**Notch Point® (-NP)**

- Reduces bellmouth and lead-off
- Increases stability in deep hole applications
- Reduces thrust
- Can be used in addition to other geometries like cast iron, high rake, and high impact



**High Impact (-HI)**

- Designed for materials with hardness > 200 BHN (700 N/mm<sup>2</sup>)
- Enhances chip formation in materials with high elasticity/ductility and poor chip forming characteristics
- SK corner clip improves tool life
- Target materials: structural/cast and forged steels (not suitable for stainless steel)

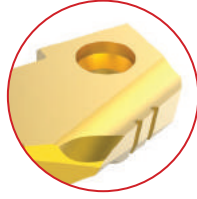

**High Impact Notch Point® (-IN)**

- Combination of high impact and Notch Point geometries
- Increases stability in deep hole applications
- Enhances chip formation in materials with high elasticity/ductility and poor chip forming characteristics

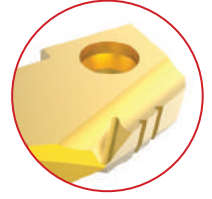

**High Rake (-HR)**

- Designed for materials with hardness < 200 BHN (700 N/mm<sup>2</sup>)
- Improves chip formation in materials with very high elasticity/ductility, extremely poor chip forming characteristics, and low material hardness
- SK corner clip improves tool life
- Target materials: soft steels, steel castings and forgings (not suitable for stainless steel)

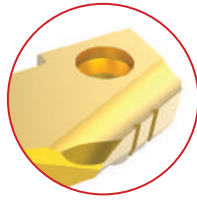

**High Rake Notch Point® (-RN)**

- Combination of high rake and Notch Point geometries
- Reduces bellmouth and lead-off
- Improves chip formation in materials with very high elasticity/ductility, extremely poor chip forming characteristics, and low material hardness

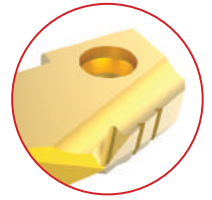

**Cast Iron (-CI)**

- Specifically designed for use in grey and white cast irons
- Exceptional edge strength
- SK2 corner preparation for improved tool life
- Standard geometry on C3 (K10) carbide inserts

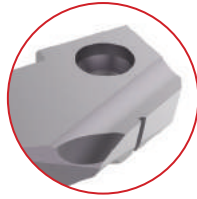

**Cast Iron Notch Point® (-CN)**

- Combination of cast iron and Notch Point geometries
- Increases stability in deep hole applications
- Specifically designed for use in grey and white cast irons

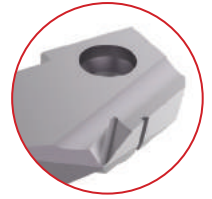

**Aluminum (-AN)**

- First choice for machining aluminum
- Enhanced geometry improves chip formation and hole quality
- TiN coating improves heat resistance and extends tool life

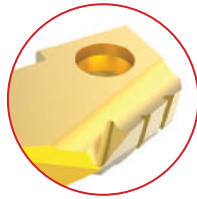

**Brass (-BR)**

- Improves tool life due to the specialized geometry and edge preparation
- Reduces self-feed tendency

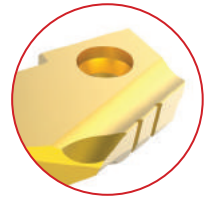

**90° Spot and Chamfer (-SP)**

- Center cutting web design improves stability and strength
- Eliminates the need for a secondary chamfering operation
- Available with chipbreakers (see -SW below)

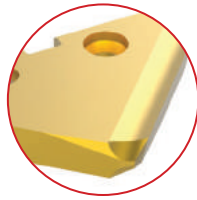

**Flat Bottom (-FB)**

- Ideal for flattening or squaring the bottom of preexisting holes with high rigidity
- Includes small 10° point on the nose of the insert
- Available without chipbreakers (see -FN below)

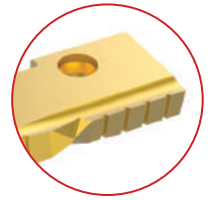

**90° Spot and Chamfer (-SW)**

- Center cutting web design improves stability and strength
- Eliminates the need for a secondary chamfering operation
- With added chipbreakers

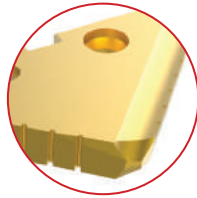

**Flat Bottom (-FN)**

- Ideal for flattening or squaring the bottom of preexisting holes with high rigidity
- Includes small 10° point on the nose of the insert
- Available with chipbreakers (see -FB above)

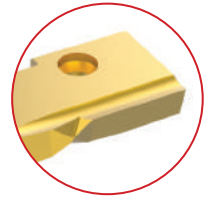

## Available Standard Insert Geometries

The following table shows which geometries are available as a standard item (based on insert type and series). If you need a geometry on your insert but it is not listed as available, please call the Application Engineering department to discuss quoting your insert as a special to include the desired geometry.

Additional lead time and process fees may apply.

Available Additional Geometries		GEN2 T-A®			T-A®						
		Y - 2 Series	3 - 4 Series	5 - 8 Series	HSS Inserts				Carbide Inserts		
		Y - 2 Series	3 - 4 Series	5 - 8 Series	Y - 2 Series	3 Series	4 Series	5 - 8 Series	Y - Z Series	0 - 2 Series	3 Series
-AN	Aluminum				●				●	●	
-BT	BT-A Specific								●	●	●
-BR	Brass		●	●	●	●	●	●	●	●	●
-CI	Cast Iron		●		●	●	●		●	●	●
-CN	Cast Iron Notch Point®				●	●			●	●	●
-CP	Cam Point				●				●	●	
-CR	Corner Radius		●	●	●	●	●	●	●	●	●
-FB	Flat Bottom				●	●	●		●	●	
-FN	Flat Bottom				●	●	●		●	●	
-HE	High Efficiency	●	●								
-HI	High Impact		●	●	●	●	●	●	●	●	●
-HR	High Rake		●	●	●	●	●	●	●	●	●
-IN	High Impact Notch Point®				●	●			●	●	●
-NC	No Chipbreaker		●	●	●	●	●	●	●	●	●
-NP	Notch Point®				●	●			●	●	●
-RN	High Rake Notch Point®				●	●			●	●	●
-SK	Special Corner Preparation		●	●	●	●	●	●	●	●	●
-SP	90° Spot and Chamfer				●	●					
-SW	90° Spot and Chamfer				●	●					
-TC	Tiny Chip				●	●	●	●	●	●	●
-WC	No Corner Clips		●	●	●	●	●	●	●	●	●

## Drill Holders

**Holder Length Options** (for use with both T-A GEN2 and T-A inserts)



**Stub Length** | Series: Y - 3 (straight flute flanged shank only)



**Short Length** | Series: ALL



**Intermediate Length** | Series: ALL



**Standard Length** | Series: ALL



**Standard Plus Length** | Series: Y - 2 (helical flute flanged shank only)



**Extended Length** | Series: 0 - 3



**Long Length** | Series: 0 - 2



**Long Plus Length** | Series: 0



**XL Length** | Series: ALL



**3XL Length** | Series: ALL

**Holder Shank Options**



**ER Collet Shank**  
Series: Y, Z, 0



**Straight Shank**  
Series: ALL



**Morse Taper Shank**  
Series: ALL



**Flanged Shank**  
Series: ALL

### Half Series Holders (0.5, 1.5, 2.5)

Half series holders are recommended when running carbide inserts toward the upper end of the series drill range, as well as in tougher applications requiring more insert support and holder strength. **NOTE:** Only specified half series inserts should be used with half series holders.



Standard Series Insert +  
Standard Series Holder



Half Series Insert +  
Standard Series Holder



Half Series Insert +  
Half Series Holder



Standard Series Insert +  
Half Series Holder

**⚠ WARNING** Refer to Speed and Feed charts for recommended adjustments to speeds and feeds. Refer to page A30: 146 for deep hole drilling guidelines in this section of the catalog. Visit [www.alliedmachine.com/DeepHoleGuidelines](http://www.alliedmachine.com/DeepHoleGuidelines) for the most up-to-date information and procedures. Factory technical assistance is available for your specific applications through our Application Engineering Team.

## Technical Information

### Next Level Solutions: GEN2 T-A®

What takes a solution to the next level? When you make innovative designs and enhancements to a product that already achieves high performance results, you push the boundaries of what is known. And when you push the known boundaries, the unknown becomes the next level.

After all, everything begins as unknown.

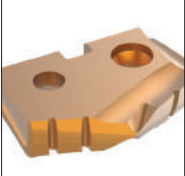
	<p style="text-align: center;"><b>AM300® Coating</b></p> <ul style="list-style-type: none"> <li>• Provides superior tool life at high penetration rates</li> <li>• Improves heat resistance over AM200® coating</li> <li>• Increases tool life up to 20% over AM200 coating</li> </ul>
---	--

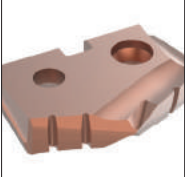
	<p style="text-align: center;"><b>AM200® Coating</b></p> <ul style="list-style-type: none"> <li>• Improves heat resistance over TiN, TiCN, and TiAlN with improved wear capabilities</li> <li>• Increases penetration rates</li> <li>• Increases tool life more than 20% over TiAlN coating</li> </ul>
---	--

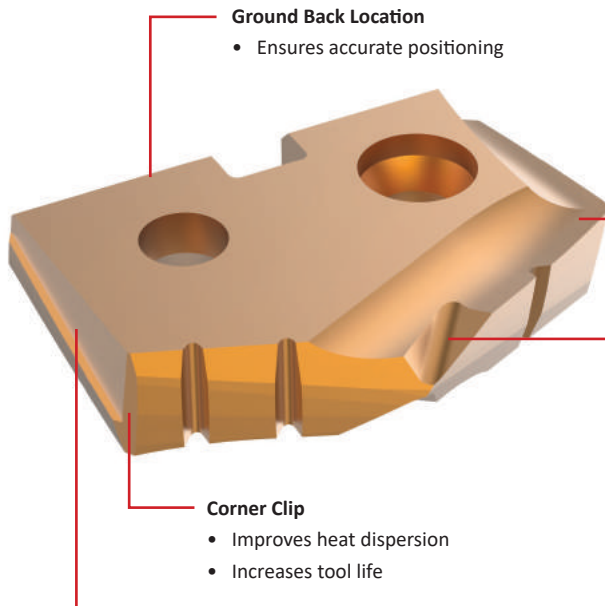

**Ground Back Location**

- Ensures accurate positioning

**Curved Cutting Edge** (not all series)

- Enhances chip formation

**Notch Point® Geometry**

- Improves stability and hole straightness
- Reduces thrust

**Corner Clip**

- Improves heat dispersion
- Increases tool life

**Helical Margin** (not all series)

- Increases drill stability

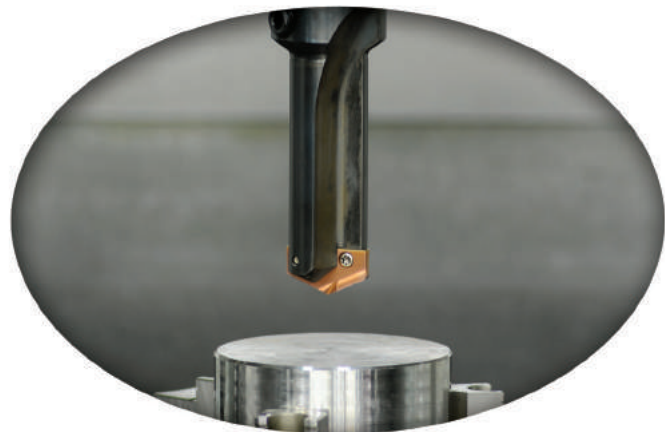

### Improving Chip Formation

Achieving optimal chip formation is crucial. The quality of the chips being produced directly affects everything in the entire process: the cycle time, the tool life, the scrap rate, and the quality and condition of the final machined hole.

We know how important chip formation is. That's why we constantly improve and develop new geometries to create a better, more productive T-A product.

### Setting Up New Applications

- Check coolant flows adequately through the tool before beginning
- Drill a short hole 1xD deep initially
- The chips produced should be short in length and material colored, not straw or blue
- Measure the hole produced to check that it is within the desired tolerance
- If all is correct, continue to machine the remainder of the hole
- Ensure the drilling process is quiet and smooth with no chip packing

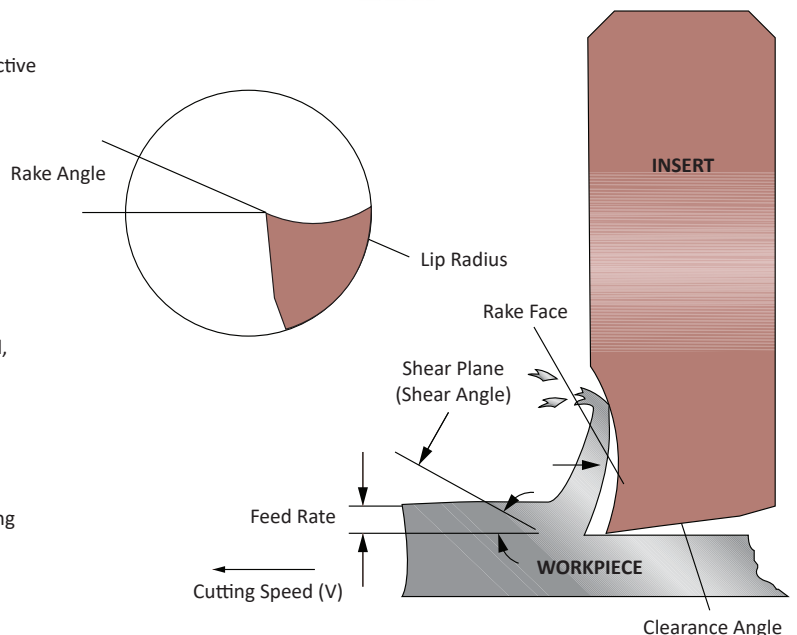



**Wear vs Toughness**

When selecting a grade of cutting tool material for your application, both wear resistance and grade toughness should be considered. The greater the wear resistance a cutting tool material exhibits, the more likely chipping or fracture is to occur. This requires more rigid machining conditions.

On the other hand, to effectively machine some materials, cobalt or carbide grades of cutting tool material may be required. The graph will aid you in the selection of a cutting tool material with the right combination of wear resistance and toughness to make your application both efficient and cost-effective.

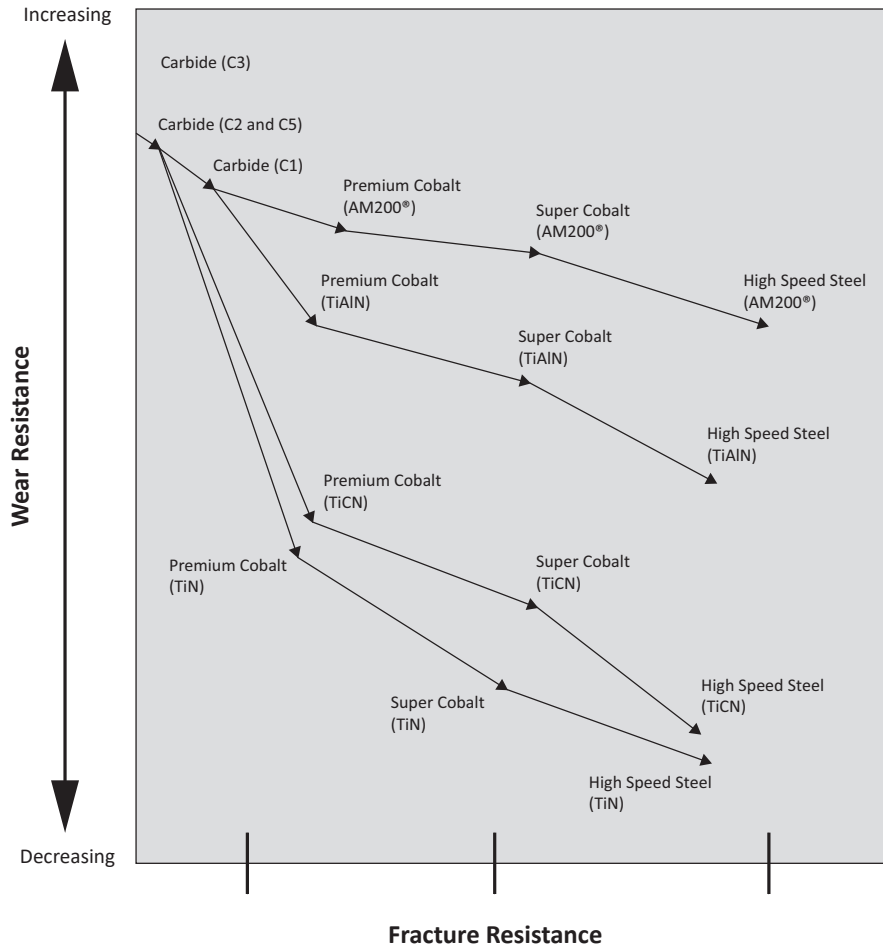
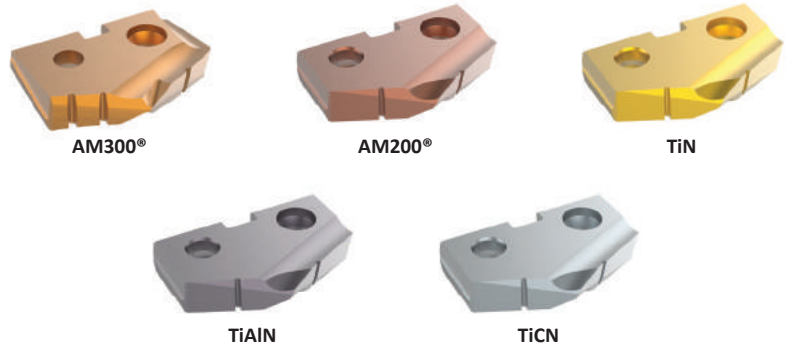

**T-A System Guidelines for Use**

- Select the shortest holder possible for the application
- Ensure the T-A holder is held securely and is within 0.003" (0.08 mm) of center line
- The T-A insert should be installed in the slot of the holder using the TORX Plus screws provided. These should be tightened to the values listed on the T-A holder pages
- The holder slot should be clean from dirt or debris
- Check that the insert outer diameter is a minimum of 0.012" (0.30 mm) larger than the holder body diameter
- Use the recommended cutting data section for guidance when selecting correct insert grades, along with speeds and feeds
- **NOTE:** These cutting parameters are starting conditions only and make no allowance for machine or component rigidity



## Product Nomenclature

### T-A Drill Inserts

<b>4</b>	<b>5</b>	<b>3</b>	<b>H</b>	-	<b>0115</b>
1	2	3	4		5

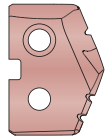

1. Insert	2. Material	3. Series	4. Coating	5. Diameter
<b>1</b> = T-A® <b>4</b> = GEN2 T-A®	<b>3</b> = HSS <b>5</b> = Super cobalt <b>8</b> = Premium cobalt <b>C1</b> = C1 (K35) carbide <b>C2</b> = C2 (K20) carbide <b>C3</b> = C3 (K10) carbide <b>C5</b> = C5 (P40) carbide	<b>Y</b> = Y series <b>4</b> = 4 series <b>Z</b> = Z series <b>5</b> = 5 series <b>0</b> = 0 series <b>6</b> = 6 series <b>1</b> = 1 series <b>7</b> = 7 series <b>2</b> = 2 series <b>8</b> = 8 series <b>3</b> = 3 series	<b>P</b> = AM300® <b>H</b> = AM200® <b>A</b> = TiAlN <b>N</b> = TiCN <b>T</b> = TiN	<b>0017</b> = Inch <b>.515</b> = Decimal <b>13</b> = Metric

### Ordering Instructions

#### ► Standard Items:

All orders are processed through Allied Machine's computerized order entry and invoicing system. Please specify the correct item number as well as a full description of the desired item(s) so we can process your order accurately and efficiently. Incorrect item numbers and/or descriptions will cause unnecessary delays and possible returns that are subject to a 10% restocking charge. Your assistance is critical if we are to achieve our goal of processing orders and shipping in-stock items error free within 24 hours.

#### ► Non-Standard Sizes and Geometries:

Nonstandard diameter	Substitute the required diameter in place of the standard diameter. Ex: Standard item number <b>132T-0101</b> Nonstandard diameter with standard geometry (inch) <b>132T-1.0200</b> (Note: 4 decimal places) Nonstandard diameter with standard geometry (metric) <b>132T-34.20</b> (Note: 2 decimal places)
Special geometry	Add the special geometry code at the end of the standard item number (see pages A30: 4 - 6 for geometry options). Ex: Standard item number <b>132T-0101</b> Standard diameter with special geometry (inch) <b>132T-0101-SK</b>
Nonstandard diameter with special geometry	Replace the standard diameter and add the special geometry code. Ex: Standard item number <b>132T-0101</b> Nonstandard diameter with special geometry (inch) <b>132T-1.0200-SK</b> (Note: 4 decimal places)

### Reference Key

Symbol	Attribute
$D_1$	Insert diameter
$T_1$	Insert thickness

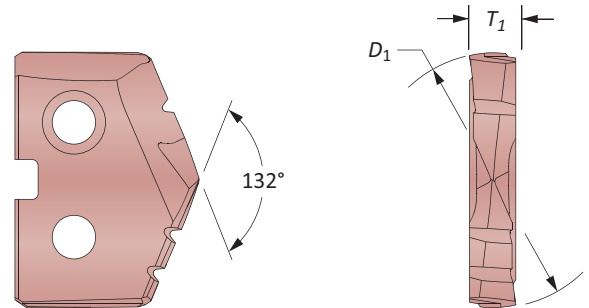

**Product Nomenclature**

**T-A Drill Holders**

<b>2</b>	<b>30</b>	<b>20</b>	<b>S</b>	-	<b>004</b>	<b>I</b>
1	2	3	4		5	6

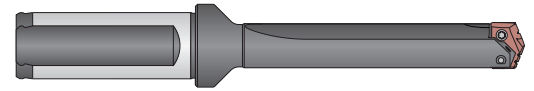

1. Holder	2. Length	3. Series	4. Flute																										
2 = T-A holder	<b>10</b> = Stub <b>20</b> = Short <b>30</b> = Intermediate <b>40</b> = Standard <b>45</b> = Standard Plus <b>50</b> = Extended <b>60</b> = Long <b>65</b> = Long Plus <b>70</b> = XL <b>90</b> = 3XL	<b>Y0</b> = Y series <b>20</b> = 2 series <b>Z0</b> = Z series <b>25</b> = 2.5 series <b>00</b> = 0 series <b>30</b> = 3 series <b>05</b> = 0.5 series <b>40</b> = 4 series <b>10</b> = 1 series <b>50</b> = 5 series <b>15</b> = 1.5 series <b>70</b> = 7 series	<b>S</b> = Straight <b>H</b> = Helical																										
5. Shank Designator	6. Shank Code																												
<table border="1"> <thead> <tr> <th>Morse Taper</th> <th>Imperial</th> <th>Metric</th> </tr> </thead> <tbody> <tr> <td><b>002</b> = 2MT</td> <td><b>063</b> = 5/8"</td> <td><b>16</b> = 16 mm</td> </tr> <tr> <td><b>003</b> = 3MT</td> <td><b>075</b> = 3/4"</td> <td><b>20</b> = 20 mm</td> </tr> <tr> <td><b>004</b> = 4MT</td> <td><b>100</b> = 1"</td> <td><b>25</b> = 25 mm</td> </tr> <tr> <td><b>005</b> = 5MT</td> <td><b>125</b> = 1-1/4"</td> <td><b>32</b> = 32 mm</td> </tr> <tr> <td></td> <td><b>150</b> = 1-1/2"</td> <td><b>40</b> = 40 mm</td> </tr> <tr> <td></td> <td><b>175</b> = 1-3/4"</td> <td><b>50</b> = 50 mm</td> </tr> <tr> <td></td> <td><b>200</b> = 2"</td> <td></td> </tr> <tr> <td></td> <td><b>300</b> = 3"</td> <td></td> </tr> </tbody> </table>	Morse Taper	Imperial	Metric	<b>002</b> = 2MT	<b>063</b> = 5/8"	<b>16</b> = 16 mm	<b>003</b> = 3MT	<b>075</b> = 3/4"	<b>20</b> = 20 mm	<b>004</b> = 4MT	<b>100</b> = 1"	<b>25</b> = 25 mm	<b>005</b> = 5MT	<b>125</b> = 1-1/4"	<b>32</b> = 32 mm		<b>150</b> = 1-1/2"	<b>40</b> = 40 mm		<b>175</b> = 1-3/4"	<b>50</b> = 50 mm		<b>200</b> = 2"			<b>300</b> = 3"		<b>I</b> = Imperial Morse taper <b>M</b> = Metric Morse taper <b>L</b> = Lathe shank <b>F</b> = Flanged shank <b>FM</b> = Flanged metric shank <b>ER</b> = ER Collet	
Morse Taper	Imperial	Metric																											
<b>002</b> = 2MT	<b>063</b> = 5/8"	<b>16</b> = 16 mm																											
<b>003</b> = 3MT	<b>075</b> = 3/4"	<b>20</b> = 20 mm																											
<b>004</b> = 4MT	<b>100</b> = 1"	<b>25</b> = 25 mm																											
<b>005</b> = 5MT	<b>125</b> = 1-1/4"	<b>32</b> = 32 mm																											
	<b>150</b> = 1-1/2"	<b>40</b> = 40 mm																											
	<b>175</b> = 1-3/4"	<b>50</b> = 50 mm																											
	<b>200</b> = 2"																												
	<b>300</b> = 3"																												

**Reference Key**

Symbol	Attribute
$D_2$	Shank diameter
$L_1$	Overall length
$L_2$	Drill depth
$L_3$	Holder reference length
$L_4$	Holder length
$L_7$	Shank length
$P_1$	Rear pipe tap
$P_2$	Side pipe tap
<b>RCA</b>	Corresponding RCA item number
<b>MT</b>	Morse taper size
<b>ER</b>	ER collet size

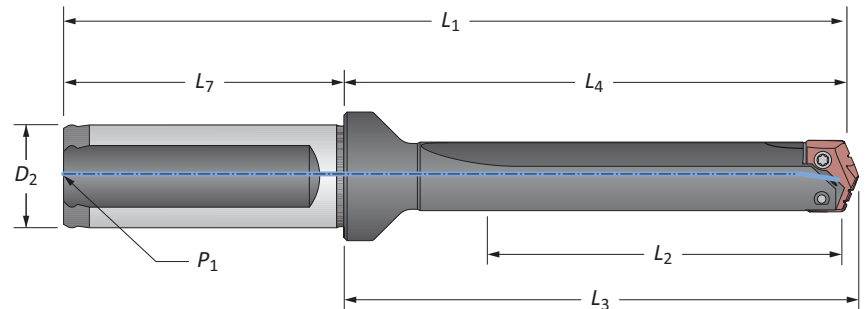

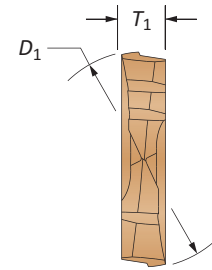
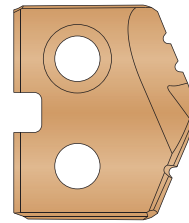
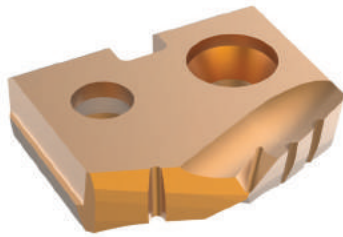

## GEN2 T-A® Drill Inserts

Y Series | Diameter Range: 0.374" - 0.436" (9.50 mm - 11.07 mm)



HSS Inserts – Super Cobalt • Carbide Inserts – C2 (K20) | C1 (K35)

Fractional Equivalent	Insert			HSS Part No.	Carbide Part No.	
	$D_1$ inch	$D_1$ mm	$T_1$	 AM200® Super Cobalt	 AM300® C2 (K20)	 AM300® C1 (K35)
–	0.3740	9.50	3/32	45YH-9.5	4C2YP-9.5	4C1YP-9.5
3/8	0.3750	9.53	3/32	45YH-0012	4C2YP-0012	4C1YP-0012
W	0.3860	9.80	3/32	45YH-.386	4C2YP-.386	4C1YP-.386
25/64	0.3906	9.92	3/32	45YH-.390	4C2YP-.390	4C1YP-.390
–	0.3937	10.00	3/32	45YH-10	4C2YP-10	4C1YP-10
–	0.4016	10.20	3/32	45YH-10.2	4C2YP-10.2	4C1YP-10.2
13/32	0.4063	10.32	3/32	45YH-0013	4C2YP-0013	4C1YP-0013
–	0.4134	10.50	3/32	45YH-10.5	4C2YP-10.5	4C1YP-10.5
27/64	0.4219	10.72	3/32	45YH-.421	4C2YP-.421	4C1YP-.421
–	0.4252	10.80	3/32	45YH-10.8	4C2YP-10.8	4C1YP-10.8
–	0.4331	11.00	3/32	45YH-11	4C2YP-11	4C1YP-11

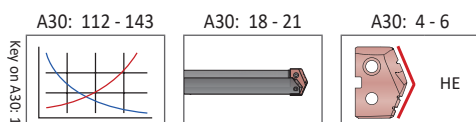

Coatings not listed above can be supplied as non-stocked standards. Process fees apply. →

TiN = 45YT-XXXX	TiAlN = 45YA-XXXX
TiCN = 45YN-XXXX	AM200® = 45YH-XXXX



Inserts sold in quantities of 2



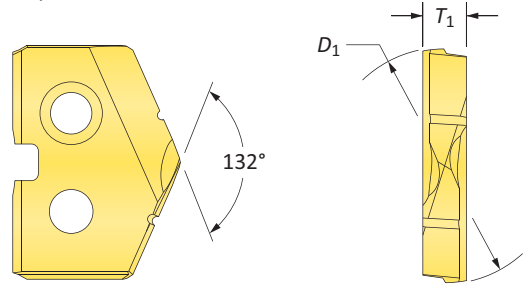
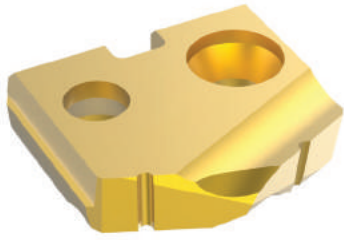

## T-A® Drill Inserts

Y Series | HSS | Diameter Range: 0.374" - 0.436" (9.50 mm - 11.07 mm)

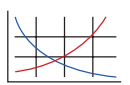

### HSS Inserts – Premium Cobalt

Fractional Equivalent	Insert			Part No.		
	$D_1$ inch	$D_1$ mm	$T_1$	 TiN	 TiAlN	 TiCN
-	0.3740	9.50	3/32	<b>18YT-9.5</b>	<b>18YA-9.5</b>	<b>18YN-9.5</b>
3/8	0.3750	9.53	3/32	<b>18YT-0012</b>	<b>18YA-0012</b>	<b>18YN-0012</b>
W	0.3860	9.80	3/32	<b>18YT-.386</b>	<b>18YA-.386</b>	<b>18YN-.386</b>
25/64	0.3906	9.92	3/32	<b>18YT-.390</b>	<b>18YA-.390</b>	<b>18YN-.390</b>
-	0.3937	10.00	3/32	<b>18YT-10</b>	<b>18YA-10</b>	<b>18YN-10</b>
-	0.4016	10.20	3/32	<b>18YT-10.2</b>	<b>18YA-10.2</b>	<b>18YN-10.2</b>
13/32	0.4063	10.32	3/32	<b>18YT-0013</b>	<b>18YA-0013</b>	<b>18YN-0013</b>
-	0.4134	10.50	3/32	<b>18YT-10.5</b>	<b>18YA-10.5</b>	<b>18YN-10.5</b>
27/64	0.4219	10.72	3/32	<b>18YT-.421</b>	<b>18YA-.421</b>	<b>18YN-.421</b>
-	0.4252	10.80	3/32	<b>18YT-10.8</b>	<b>18YA-10.8</b>	<b>18YN-10.8</b>
-	0.4331	11.00	3/32	<b>18YT-11</b>	<b>18YA-11</b>	<b>18YN-11</b>

A30: 112 - 143   A30: 18 - 21  A30: 4 - 6  HI, HR, CR, TC, SK, NP, IN, RN, CN, AN, BR, CI, CP, NC, WC

Coatings not listed above can be supplied as non-stocked standards. Process fees apply. 

Inserts sold in quantities of 2



<b>TiN = 18YT-XXXX</b>	<b>TiAlN = 18YA-XXXX</b>
<b>TiCN = 18YN-XXXX</b>	<b>AM200® = 18YH-XXXX</b>

## T-A® Drill Inserts

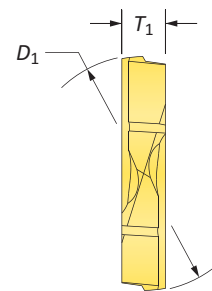
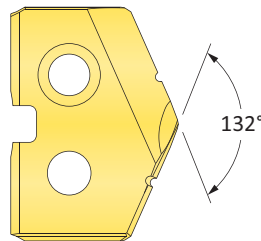
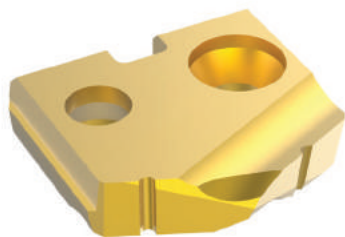
Y Series | HSS | Diameter Range: 0.374" - 0.436" (9.50 mm - 11.07 mm)



### HSS Inserts – Super Cobalt

Fractional Equivalent	Insert			Part No.		
	$D_1$ inch	$D_1$ mm	$T_1$	 TiN	 TiAlN	 TiCN
–	0.3740	9.50	3/32	15YT-9.5	15YA-9.5	15YN-9.5
3/8	0.3750	9.53	3/32	15YT-0012	15YA-0012	15YN-0012
W	0.3860	9.80	3/32	15YT-386	15YA-386	15YN-386
25/64	0.3906	9.92	3/32	15YT-390	15YA-390	15YN-390
–	0.3937	10.00	3/32	15YT-10	15YA-10	15YN-10
–	0.4016	10.20	3/32	15YT-10.2	15YA-10.2	15YN-10.2
13/32	0.4063	10.32	3/32	15YT-0013	15YA-0013	15YN-0013
–	0.4134	10.50	3/32	15YT-10.5	15YA-10.5	15YN-10.5
27/64	0.4219	10.72	3/32	15YT-421	15YA-421	15YN-421
–	0.4252	10.80	3/32	15YT-10.8	15YA-10.8	15YN-10.8
–	0.4331	11.00	3/32	15YT-11	15YA-11	15YN-11

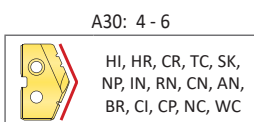
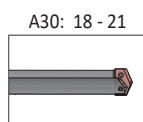
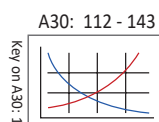

Coatings not listed above can be supplied as non-stocked standards. Process fees apply. →

TiN = 15YT-XXXX	TiAlN = 15YA-XXXX
TiCN = 15YN-XXXX	AM200® = 15YH-XXXX

Inserts sold in quantities of 2



### T-A® Drill Inserts

Y Series | HSS | Diameter Range: 0.374" - 0.436" (9.50 mm - 11.07 mm)

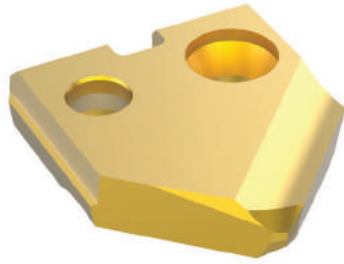



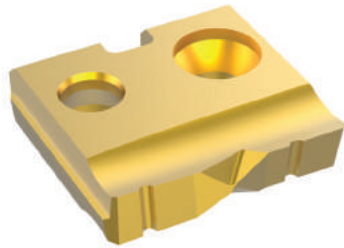
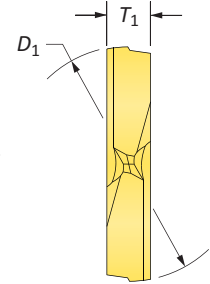
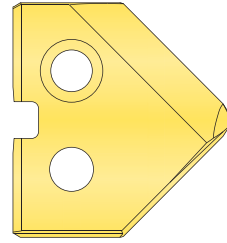

90° Spot & Chamfer

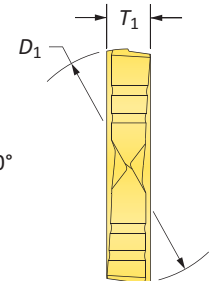
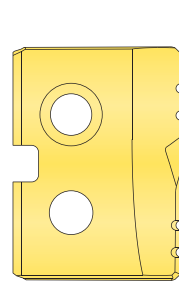

Flat Bottom



### HSS Inserts – Super Cobalt

Fractional Equivalent	Insert			90° Spot & Chamfer Part No.			Flat Bottom Part No.
	D <sub>1</sub> inch	D <sub>1</sub> mm	T <sub>1</sub>	 TiN	 TiAlN	 TiCN	 TiN
–	0.3740	9.50	3/32	15YT-9.5-SP	15YA-9.5-SP	15YN-9.5-SP	15YT-9.5-FB
3/8	0.3750	9.53	3/32	15YT-0012-SP	15YA-0012-SP	15YN-0012-SP	15YT-0012-FB
W	0.3860	9.80	3/32	15YT-.386-SP	15YA-.386-SP	15YN-.386-SP	15YT-.386-FB
25/64	0.3906	9.92	3/32	15YT-.390-SP	15YA-.390-SP	15YN-.390-SP	15YT-.390-FB
–	0.3937	10.00	3/32	15YT-10-SP	15YA-10-SP	15YN-10-SP	15YT-10-FB
–	0.4016	10.20	3/32	15YT-10.2-SP	15YA-10.2-SP	15YN-10.2-SP	15YT-10.2-FB
13/32	0.4063	10.32	3/32	15YT-0013-SP	15YA-0013-SP	15YN-0013-SP	15YT-0013-FB
–	0.4134	10.50	3/32	15YT-10.5-SP	15YA-10.5-SP	15YN-10.5-SP	15YT-10.5-FB
27/64	0.4219	10.72	3/32	15YT-.421-SP	15YA-.421-SP	15YN-.421-SP	15YT-.421-FB
–	0.4252	10.80	3/32	15YT-10.8-SP	15YA-10.8-SP	15YN-10.8-SP	15YT-10.8-FB
–	0.4331	11.00	3/32	15YT-11-SP	15YA-11-SP	15YN-11-SP	15YT-11-FB

A30: 112 - 143

A30: 18 - 21

A30: 4 - 6

A30: 4 - 6

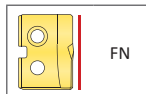
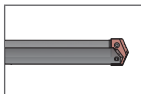
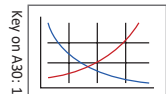

Inserts sold in quantities of 2

Coatings not listed above can be supplied as non-stocked standards. Process fees apply. →

TiN = 15YT-XXXX	TiAlN = 15YA-XXXX
TiCN = 15YN-XXXX	AM200® = 15YH-XXXX

## T-A® Drill Inserts

Y Series | Carbide | Diameter Range: 0.374" - 0.436" (9.50 mm - 11.07 mm)

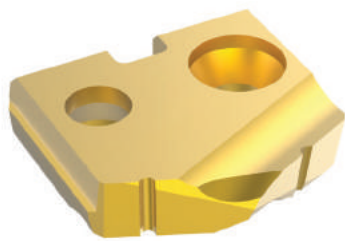

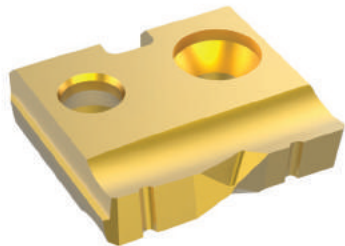
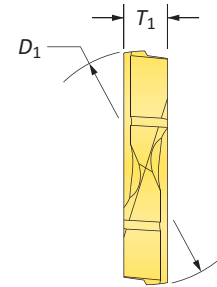
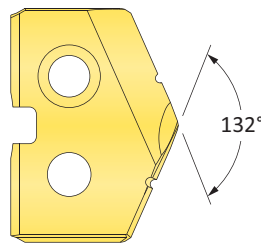

Standard

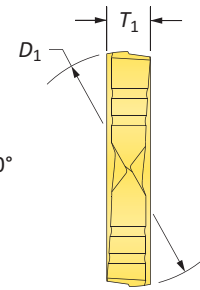
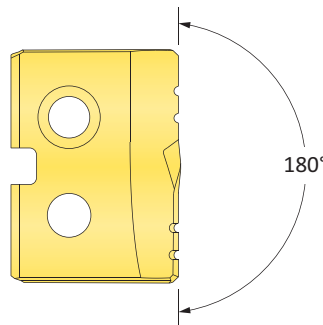

Flat Bottom



### Carbide Inserts – C2 (K20)

Fractional Equivalent	Insert			Part No.		Flat Bottom Part No.
	$D_1$ inch	$D_1$ mm	$T_1$	 TiN	 TiAlN	 TiN
-	0.3740	9.50	3/32	<b>1C2YT-9.5</b>	<b>1C2YA-9.5</b>	<b>1C2YT-9.5-FB</b>
3/8	0.3750	9.53	3/32	<b>1C2YT-0012</b>	<b>1C2YA-0012</b>	<b>1C2YT-0012-FB</b>
W	0.3860	9.80	3/32	<b>1C2YT-.386</b>	<b>1C2YA-.386</b>	<b>1C2YT-.386-FB</b>
25/64	0.3906	9.92	3/32	<b>1C2YT-.390</b>	<b>1C2YA-.390</b>	<b>1C2YT-.390-FB</b>
-	0.3937	10.00	3/32	<b>1C2YT-10</b>	<b>1C2YA-10</b>	<b>1C2YT-10-FB</b>
-	0.4016	10.20	3/32	<b>1C2YT-10.2</b>	<b>1C2YA-10.2</b>	<b>1C2YT-10.2-FB</b>
13/32	0.4063	10.32	3/32	<b>1C2YT-0013</b>	<b>1C2YA-0013</b>	<b>1C2YT-0013-FB</b>
-	0.4134	10.50	3/32	<b>1C2YT-10.5</b>	<b>1C2YA-10.5</b>	<b>1C2YT-10.5-FB</b>
27/64	0.4219	10.72	3/32	<b>1C2YT-.421</b>	<b>1C2YA-.421</b>	<b>1C2YT-.421-FB</b>
-	0.4252	10.80	3/32	<b>1C2YT-10.8</b>	<b>1C2YA-10.8</b>	<b>1C2YT-10.8-FB</b>
-	0.4331	11.00	3/32	<b>1C2YT-11</b>	<b>1C2YA-11</b>	<b>1C2YT-11-FB</b>

A30: 112 - 143

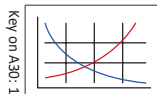

A30: 18 - 21

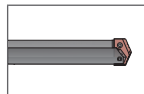

A30: 4 - 6

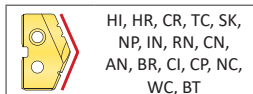

HI, HR, CR, TC, SK,  
NP, IN, RN, CN,  
AN, BR, CI, CP, NC,  
WC, BT

A30: 4 - 6

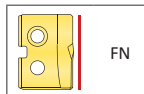

FN

Coatings not listed above can be supplied as non-stocked standards. Process fees apply. →

TiN = 1C2YT-XXXX	TiAlN = 1C2YA-XXXX
TiCN = 1C2YN-XXXX	AM200® = 1C2YH-XXXX

Inserts sold in quantities of 1







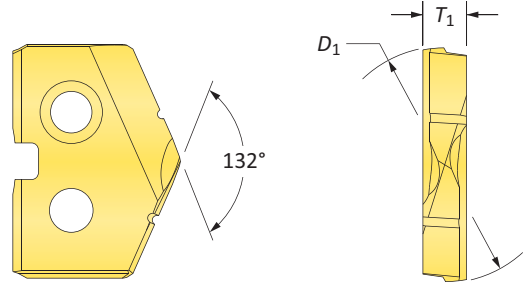
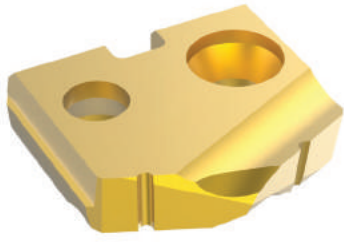

**T-A® Drill Inserts**

Y Series | Carbide | Diameter Range: 0.374" - 0.436" (9.50 mm - 11.07 mm)



Carbide Inserts – C5 (P40) | C3 (K10) | N2

Fractional Equivalent	Insert			C5 Part No.		C3 Part No.	N2 Part No.
	D <sub>1</sub> inch	D <sub>1</sub> mm	T <sub>1</sub>	 TiN	 TiAlN	 TiAlN (Cast Iron)	 Diamond Film*
-	0.3740	9.50	3/32	<b>1C5YT-9.5</b>	<b>1C5YA-9.5</b>	<b>1C3YA-9.5-CI</b>	<b>1N2YD-9.5</b>
3/8	0.3750	9.53	3/32	<b>1C5YT-0012</b>	<b>1C5YA-0012</b>	<b>1C3YA-0012-CI</b>	<b>1N2YD-0012</b>
W	0.3860	9.80	3/32	<b>1C5YT-.386</b>	<b>1C5YA-.386</b>	<b>1C3YA-.386-CI</b>	<b>1N2YD-.386</b>
25/64	0.3906	9.92	3/32	<b>1C5YT-.390</b>	<b>1C5YA-.390</b>	<b>1C3YA-.390-CI</b>	<b>1N2YD-.390</b>
-	0.3937	10.00	3/32	<b>1C5YT-10</b>	<b>1C5YA-10</b>	<b>1C3YA-10-CI</b>	<b>1N2YD-10</b>
-	0.4016	10.20	3/32	<b>1C5YT-10.2</b>	<b>1C5YA-10.2</b>	<b>1C3YA-10.2-CI</b>	<b>1N2YD-10.2</b>
13/32	0.4063	10.32	3/32	<b>1C5YT-0013</b>	<b>1C5YA-0013</b>	<b>1C3YA-0013-CI</b>	<b>1N2YD-0013</b>
-	0.4134	10.50	3/32	<b>1C5YT-10.5</b>	<b>1C5YA-10.5</b>	<b>1C3YA-10.5-CI</b>	<b>1N2YD-10.5</b>
27/64	0.4219	10.72	3/32	<b>1C5YT-.421</b>	<b>1C5YA-.421</b>	<b>1C3YA-.421-CI</b>	<b>1N2YD-.421</b>
-	0.4252	10.80	3/32	<b>1C5YT-10.8</b>	<b>1C5YA-10.8</b>	<b>1C3YA-10.8-CI</b>	<b>1N2YD-10.8</b>
-	0.4331	11.00	3/32	<b>1C5YT-11</b>	<b>1C5YA-11</b>	<b>1C3YA-11-CI</b>	<b>1N2YD-11</b>

\*Diamond Film is only available in standard geometry. For additional geometries, please contact Application Engineering.

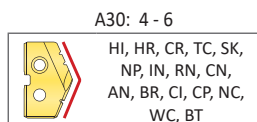
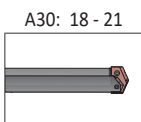
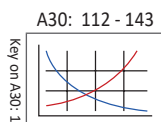

Coatings not listed above can be supplied as non-stocked standards. Process fees apply. →

Inserts sold in quantities of 1

<b>TiN = 1C5YT-XXXX</b>	<b>TiAlN = 1C5YA-XXXX</b>
<b>TiCN = 1C5YN-XXXX</b>	<b>AM200® = 1C5YH-XXXX</b>

## T-A® Drill Insert Holders

Y Series | Flange Shank | Diameter Range: 0.374" - 0.436" (9.50 mm - 11.07 mm)

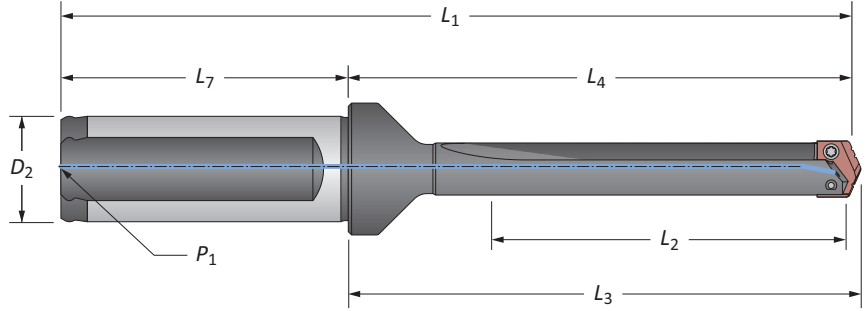

### Straight Flute

Length	Body				Shank			Part No.
	L <sub>2</sub>	L <sub>4</sub>	L <sub>3</sub>	L <sub>1</sub>	D <sub>2</sub>	L <sub>7</sub>	P <sub>1</sub>	
<b>i</b> Short	1-1/4	2-13/32	2-1/2	4-7/16	3/4	2-1/32	1/8	220Y0S-075F
<b>i</b> Standard	2-3/8	3-17/32	3-5/8	5-9/16	3/4	2-1/32	1/8	240Y0S-075F
<b>i</b> Extended	4-3/8	5-17/32	5-5/8	7-9/16	3/4	2-1/32	1/8	▲ 250Y0S-075F
<b>m</b> Short	31.8	61.1	63.5	111.1	20.0	50.0	1/8*	220Y0S-20FM
<b>m</b> XL	222	251.7	254.1	301.7	20.0	50.0	1/8*	▲ 270Y0S-20FM
<b>m</b> 3XL	290	319.9	322.3	369.9	20.0	50.0	1/8*	▲ 290Y0S-20FM

\*Metric thread to BSP and ISO 7-1

**NOTE:** Stub length holders have a 1/8" side pipe tap (P<sub>2</sub>)

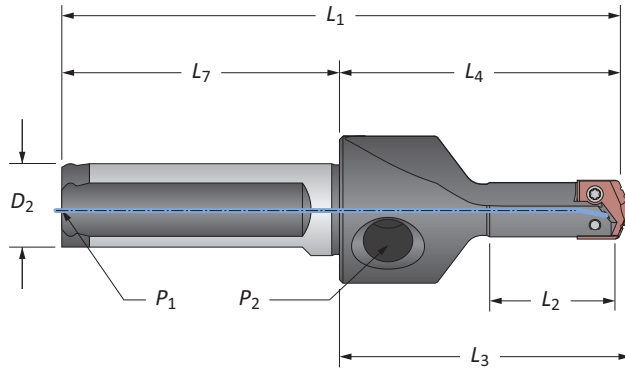

### Straight Flute (Stub Length)

Length	Body				Shank			Part No.
	L <sub>2</sub>	L <sub>4</sub>	L <sub>3</sub>	L <sub>1</sub>	D <sub>2</sub>	L <sub>7</sub>	P <sub>1</sub>	
<b>i</b> Stub	3/4	1-7/8	1-31/32	3-3/4	5/8	1-7/8	1/16	210Y0S-063F
<b>m</b> Stub	19.1	47.6	50.0	95.6	16.0	48.0	1/16*	210Y0S-16FM

\*Metric thread to BSP and ISO 7-1

**NOTE:** Stub length holders have a 1/8" side pipe tap (P<sub>2</sub>)

### Connection Accessories

Insert Screws	Nylon Locking Screws	Insert Driver	Preset Torque Hand Driver	Replacement Tips	Admissible Tightening Torque*
724-IP7-1	724N-IP7-1	8IP-7	8IP-7TL	8IP-7B	7.4 in-lbs (84 N-cm)

\*Tightening torques are calculated with a friction coefficient of  $\mu = 0.14$  and develop 90% of ultimate yield strength

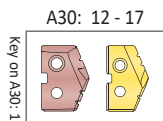

**i** = Imperial (in)  
**m** = Metric (mm)

Screws sold in quantities of 10

**WARNING** Refer to Speed and Feed charts for recommended adjustments to speeds and feeds. Refer to page A30: 146 for deep hole drilling guidelines in this section of the catalog. Visit [www.alliedmachine.com/DeepHoleGuidelines](http://www.alliedmachine.com/DeepHoleGuidelines) for the most up-to-date information and procedures. Factory technical assistance is available for your specific applications through our Application Engineering Team.

## T-A® Drill Insert Holders

Y Series | Flange Shank | Diameter Range: 0.374" - 0.436" (9.50 mm - 11.07 mm)

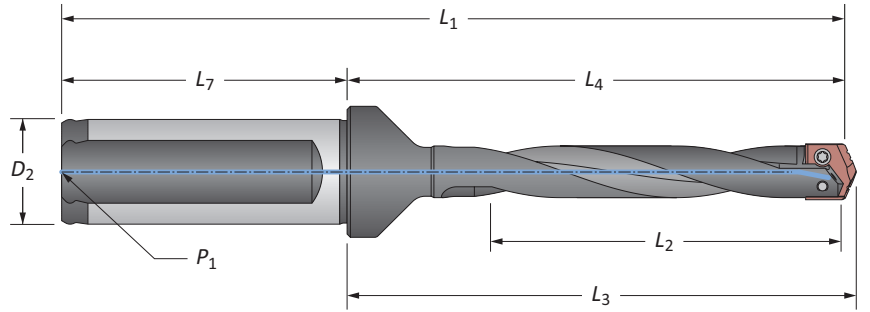

### Helical Flute

Length	Body				Shank			Part No.
	L <sub>2</sub>	L <sub>4</sub>	L <sub>3</sub>	L <sub>1</sub>	D <sub>2</sub>	L <sub>7</sub>	P <sub>1</sub>	
<b>i</b> Standard	2-3/8	3-17/32	3-5/8	5-9/16	3/4	2-1/32	1/8	240Y0H-075F
<b>i</b> Standard Plus	3-3/8	4-35/64	4-41/64	6-43/64	3/4	2-1/32	1/8	<b>⚠</b> 245Y0H-075F
<b>i</b> Extended	4-3/8	5-17/32	5-5/8	7-9/16	3/4	2-1/32	1/8	<b>⚠</b> 250Y0H-075F
<b>m</b> Standard	60.3	89.7	92.1	139.7	20.0	50.0	1/8*	240Y0H-20FM
<b>m</b> Standard Plus	86.0	115.4	117.8	165.4	20.0	50.0	1/8*	<b>⚠</b> 245Y0H-20FM
<b>m</b> Extended	111.1	140.5	142.9	190.5	20.0	50.0	1/8*	<b>⚠</b> 250Y0H-20FM

\*Metric thread to BSP and ISO 7-1

### Connection Accessories

Insert Screws	Nylon Locking Screws	Insert Driver	Preset Torque Hand Driver	Replacement Tips	Admissible Tightening Torque*
724-IP7-1	724N-IP7-1	8IP-7	8IP-7TL	8IP-7B	7.4 in-lbs (84 N-cm)

\*Tightening torques are calculated with a friction coefficient of  $\mu = 0.14$  and develop 90% of ultimate yield strength

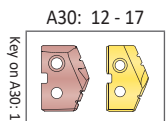

**i** = Imperial (in)  
**m** = Metric (mm)

Screws sold in quantities of 10

**⚠ WARNING** Refer to Speed and Feed charts for recommended adjustments to speeds and feeds. Refer to page A30: 146 for deep hole drilling guidelines in this section of the catalog. Visit [www.alliedmachine.com/DeepHoleGuidelines](http://www.alliedmachine.com/DeepHoleGuidelines) for the most up-to-date information and procedures. Factory technical assistance is available for your specific applications through our Application Engineering Team.

## T-A® Drill Insert Holders

Y Series | Taper Shank | Diameter Range: 0.374" - 0.436" (9.50 mm - 11.07 mm)

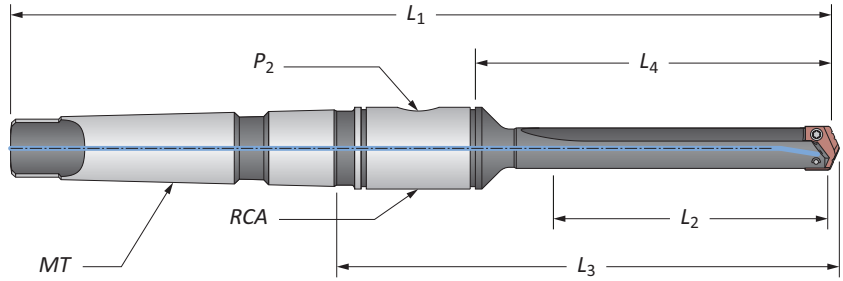

### Straight Flute

Length	Body				Shank			Part No.
	L <sub>2</sub>	L <sub>4</sub>	L <sub>3</sub>	L <sub>1</sub>	MT	P <sub>2</sub>	RCA	
Short	1-1/4	2-1/32	3-15/32	6-5/16	#2	1/16	2T-2SR	220Y0S-002I
Standard	2-3/8	3-5/32	4-19/32	7-7/16	#2	1/16	2T-2SR	240Y0S-002I
Extended	4-3/8	5-5/32	6-19/32	9-7/16	#2	1/16	2T-2SR	250Y0S-002I
Short	31.8	51.5	88.0	160.3	#2**	1/16*	2T-2SRM	220Y0S-002M

\*Metric thread to BSP and ISO 7-1

\*\*Per ISO 296 type BEK

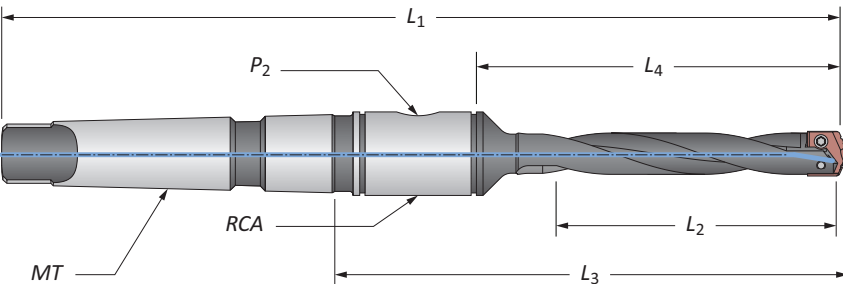

### Helical Flute

Length	Body				Shank			Part No.
	L <sub>2</sub>	L <sub>4</sub>	L <sub>3</sub>	L <sub>1</sub>	MT	P <sub>2</sub>	RCA	
Standard	2-3/8	3-5/32	4-19/32	7-7/16	#2	1/16	2T-2SR	240Y0H-002I
Extended	4-3/8	5-5/32	6-19/32	9-7/16	#2	1/16	2T-2SR	250Y0H-002I
Standard	60.3	80.2	116.7	188.9	#2**	1/16*	2T-2SRM	240Y0H-002M
Extended	111.1	130.9	167.4	239.7	#2**	1/16*	2T-2SRM	250Y0H-002M

\*Metric thread to BSP and ISO 7-1

\*\*Per ISO 296 type BEK

### Connection Accessories

Insert Screws	Nylon Locking Screws	Insert Driver	Preset Torque Hand Driver	Replacement Tips	Admissible Tightening Torque*
724-IP7-1	724N-IP7-1	8IP-7	8IP-7TL	8IP-7B	7.4 in-lbs (84 N-cm)

\*Tightening torques are calculated with a friction coefficient of  $\mu = 0.14$  and develop 90% of ultimate yield strength

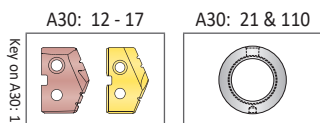

i = Imperial (in)  
m = Metric (mm)

Screws sold in quantities of 10

**WARNING** Refer to Speed and Feed charts for recommended adjustments to speeds and feeds. Refer to page A30: 146 for deep hole drilling guidelines in this section of the catalog. Visit [www.alliedmachine.com/DeepHoleGuidelines](http://www.alliedmachine.com/DeepHoleGuidelines) for the most up-to-date information and procedures. Factory technical assistance is available for your specific applications through our Application Engineering Team.

## T-A® Drill Insert Holders

Y Series | Straight Shank | ER Collet | Diameter Range: 0.374" - 0.436" (9.50 mm - 11.07 mm)

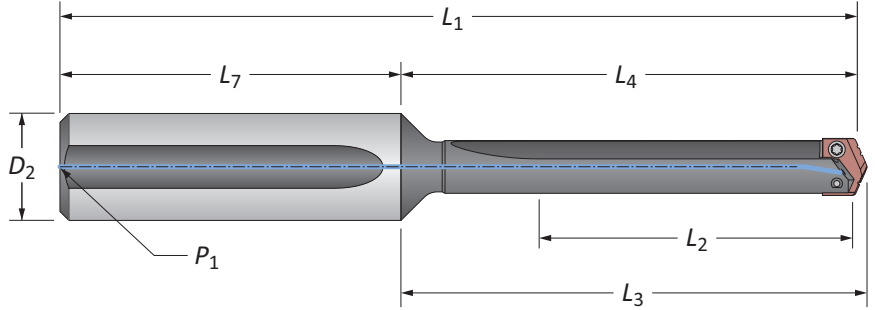

### Straight Flute

Length	Body				Shank			Part No.
	L <sub>2</sub>	L <sub>4</sub>	L <sub>3</sub>	L <sub>1</sub>	D <sub>2</sub>	L <sub>7</sub>	P <sub>1</sub>	
Short	1-1/4	2-1/32	2-1/8	4-13/32	3/4	2-3/8	1/8	220Y0S-075L
Standard	2-3/8	3-5/32	3-1/4	5-17/32	3/4	2-3/8	1/8	240Y0S-075L
Extended	4-3/8	5-5/32	5-1/4	7-17/32	3/4	2-3/8	1/8	⚠ 250Y0S-075L
XL	8-3/4	9-17/32	9-5/8	11-29/32	3/4	2-3/8	1/8	⚠ 270Y0S-075L
3XL	11-7/16	12-7/32	12-5/16	14-19/32	3/4	2-3/8	1/8	⚠ 290Y0S-075L

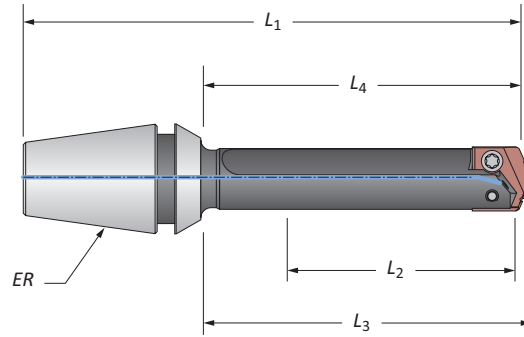

### ER Collet Holder

L <sub>2</sub>	Body			ER	Part No.	Collet Nut without Retaining Ring
	L <sub>4</sub>	L <sub>3</sub>	L <sub>1</sub>			
1-3/8	1-29/32	2	3-5/64	ER-16	210Y0S-16ER	ER-16N
1-3/8	1-29/32	2	3-15/64	ER-20	210Y0S-20ER	ER-20N

## T-A Drill Accessories

Y Series | Rotary Coolant Adapters | Torx® Plus Screws

### Rotary Coolant Adapter (RCA) and Accessories

ID	OD	L <sub>1</sub>	Driving Rod Thread	P <sub>1</sub>	Part No.	RCA O-Rings	
						Kit Part No.**	Replacements
3/4	1-3/4	7/8	5/16-18	1/8	⚠ 2T-2SR	2T1-2SR	2T1-2OR-10
19.05	44.45	22.23	M8 x 1.25	1/8*	⚠ 2T-2SRM	2T1-2SR	2T1-2OR-10

\*Thread to BSP and ISO 7-1 | \*\*RCA Repair Kit includes (2) O-rings, (2) snap rings, and (2) thrust washers

⚠ Refer to page A30: 110 for proper RCA assembly and safety information

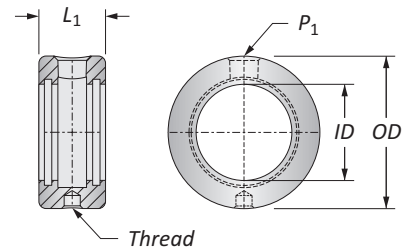

### Connection Accessories

Insert Screws	Nylon Locking Screws	Insert Driver	Preset Torque Hand Driver	Replacement Tips	Admissible Tightening Torque*
724-IP7-1	724N-IP7-1	8IP-7	8IP-7TL	8IP-7B	7.4 in-lbs (84 N-cm)

\*Tightening torques are calculated with a friction coefficient of  $\mu = 0.14$  and develop 90% of ultimate yield strength

**⚠ WARNING** Refer to Speed and Feed charts for recommended adjustments to speeds and feeds. Refer to page A30: 146 for deep hole drilling guidelines in this section of the catalog. Visit [www.alliedmachine.com/DeepHoleGuidelines](http://www.alliedmachine.com/DeepHoleGuidelines) for the most up-to-date information and procedures. Factory technical assistance is available for your specific applications through our Application Engineering Team.



ⓘ = Imperial (in)  
 ⓘ = Metric (mm)  
 Screws sold in packs of 10  
 O-rings sold in packs of 10

## GEN2 T-A® Drill Inserts

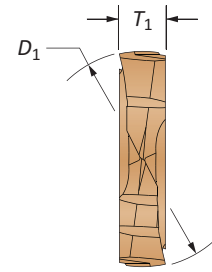
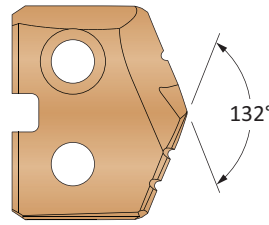
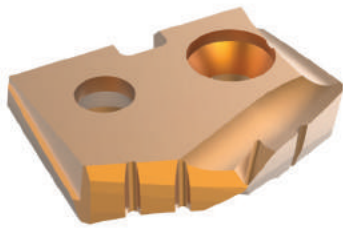
Z Series | Diameter Range: 0.437" - 0.510" (11.10 mm - 12.95 mm)



HSS Inserts – Super Cobalt • Carbide Inserts – C2 (K20) | C1 (K35)

Fractional Equivalent	Insert			HSS Part No.	Carbide Part No.	
	$D_1$ inch	$D_1$ mm	$T_1$	 AM200® Super Cobalt	 AM300® C2 (K20)	 AM300® C1 (K35)
7/16	0.4375	11.11	3/32	45ZH-0014	4C2ZP-0014	4C1ZP-0014
–	0.4510	11.46	3/32	45ZH-.451	4C2ZP-.451	4C1ZP-.451
–	0.4528	11.50	3/32	45ZH-11.5	4C2ZP-11.5	4C1ZP-11.5
29/64	0.4531	11.51	3/32	45ZH-.453	4C2ZP-.453	4C1ZP-.453
15/32	0.4688	11.91	3/32	45ZH-0015	4C2ZP-0015	4C1ZP-0015
–	0.4724	12.00	3/32	45ZH-12	4C2ZP-12	4C1ZP-12
31/64	0.4844	12.30	3/32	45ZH-.484	4C2ZP-.484	4C1ZP-.484
–	0.4921	12.50	3/32	45ZH-12.5	4C2ZP-12.5	4C1ZP-12.5
1/2	0.5000	12.70	3/32	45ZH-0016	4C2ZP-0016	4C1ZP-0016
–	0.5060	12.85	3/32	45ZH-.506	4C2ZP-.506	4C1ZP-.506
–	0.5100	12.95	3/32	45ZH-.510	4C2ZP-.510	4C1ZP-.510

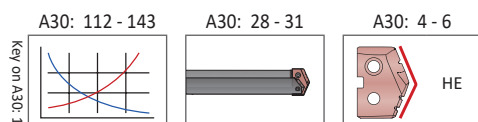

Inserts sold in quantities of 2

Coatings not listed above can be supplied as non-stocked standards. Process fees apply. →



TiN = 45ZT-XXXX	TiAlN = 45ZA-XXXX
TiCN = 45ZN-XXXX	AM200® = 45ZH-XXXX

## T-A® Drill Inserts

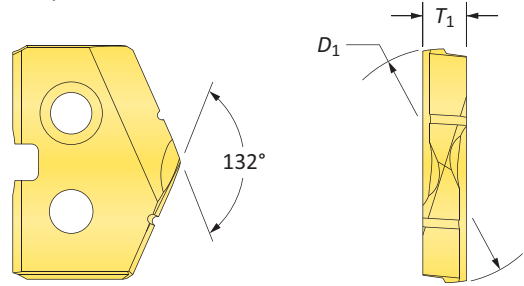
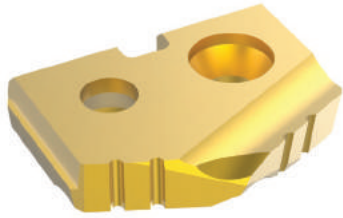
Z Series | HSS | Diameter Range: 0.437" - 0.510" (11.10 mm - 12.95 mm)



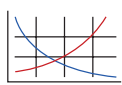

### HSS Inserts – Premium Cobalt

Fractional Equivalent	Insert			Part No.		
	$D_1$ inch	$D_1$ mm	$T_1$	 TiN	 TiAlN	 TiCN
7/16	0.4375	11.11	3/32	<b>18ZT-0014</b>	<b>18ZA-0014</b>	<b>18ZN-0014</b>
-	0.4510	11.46	3/32	<b>18ZT-.451</b>	<b>18ZA-.451</b>	<b>18ZN-.451</b>
-	0.4528	11.50	3/32	<b>18ZT-11.5</b>	<b>18ZA-11.5</b>	<b>18ZN-11.5</b>
29/64	0.4531	11.51	3/32	<b>18ZT-.453</b>	<b>18ZA-.453</b>	<b>18ZN-.453</b>
15/32	0.4688	11.91	3/32	<b>18ZT-0015</b>	<b>18ZA-0015</b>	<b>18ZN-0015</b>
-	0.4724	12.00	3/32	<b>18ZT-12</b>	<b>18ZA-12</b>	<b>18ZN-12</b>
31/64	0.4844	12.30	3/32	<b>18ZT-.484</b>	<b>18ZA-.484</b>	<b>18ZN-.484</b>
-	0.4921	12.50	3/32	<b>18ZT-12.5</b>	<b>18ZA-12.5</b>	<b>18ZN-12.5</b>
1/2	0.5000	12.70	3/32	<b>18ZT-0016</b>	<b>18ZA-0016</b>	<b>18ZN-0016</b>
-	0.5060	12.85	3/32	<b>18ZT-.506</b>	<b>18ZA-.506</b>	<b>18ZN-.506</b>
-	0.5100	12.95	3/32	<b>18ZT-.510</b>	<b>18ZA-.510</b>	<b>18ZN-.510</b>

A30: 112 - 143  Key on A30-1

A30: 28 - 31 

A30: 4 - 6  HI, HR, CR, TC, SK, NP, IN, RN, CN, AN, BR, CI, CP, NC, WC

Coatings not listed above can be supplied as non-stocked standards. Process fees apply. 

Inserts sold in quantities of 2



<b>TiN = 18ZT-XXXX</b>	<b>TiAlN = 18ZA-XXXX</b>
<b>TiCN = 18ZN-XXXX</b>	<b>AM200® = 18ZH-XXXX</b>

## T-A® Drill Inserts

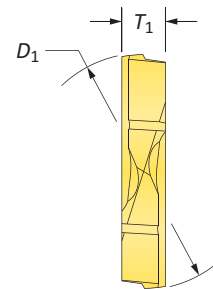
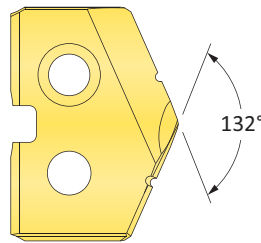
Z Series | HSS | Diameter Range: 0.437" - 0.510" (11.10 mm - 12.95 mm)



### HSS Inserts – Super Cobalt

Fractional Equivalent	Insert			Part No.		
	$D_1$ inch	$D_1$ mm	$T_1$	 TiN	 TiAlN	 TiCN
7/16	0.4375	11.11	3/32	15ZT-0014	15ZA-0014	15ZN-0014
–	0.4510	11.46	3/32	15ZT-.451	15ZA-.451	15ZN-.451
–	0.4528	11.50	3/32	15ZT-11.5	15ZA-11.5	15ZN-11.5
29/64	0.4531	11.51	3/32	15ZT-.453	15ZA-.453	15ZN-.453
15/32	0.4688	11.91	3/32	15ZT-0015	15ZA-0015	15ZN-0015
–	0.4724	12.00	3/32	15ZT-12	15ZA-12	15ZN-12
31/64	0.4844	12.30	3/32	15ZT-.484	15ZA-.484	15ZN-.484
–	0.4921	12.50	3/32	15ZT-12.5	15ZA-12.5	15ZN-12.5
1/2	0.5000	12.70	3/32	15ZT-0016	15ZA-0016	15ZN-0016
–	0.5060	12.85	3/32	15ZT-.506	15ZA-.506	15ZN-.506
–	0.5100	12.95	3/32	15ZT-.510	15ZA-.510	15ZN-.510

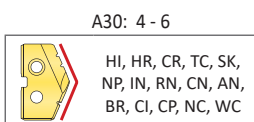
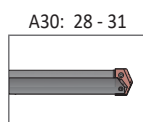
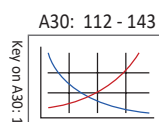

Coatings not listed above can be supplied as non-stocked standards. Process fees apply. →

TiN = 15ZT-XXXX	TiAlN = 15ZA-XXXX
TiCN = 15ZN-XXXX	AM200® = 15ZH-XXXX

Inserts sold in quantities of 2





T-A® Drill Inserts

Z Series | HSS | Diameter Range: 0.437" - 0.510" (11.10 mm - 12.95 mm)

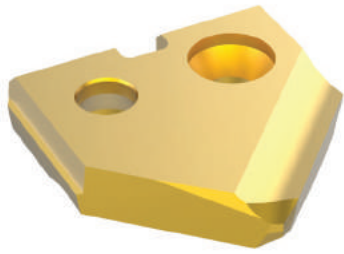

90° Spot & Chamfer

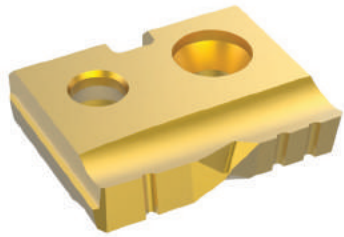
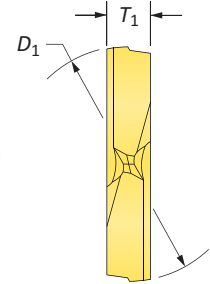
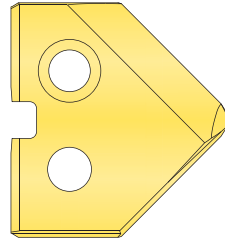

Flat Bottom

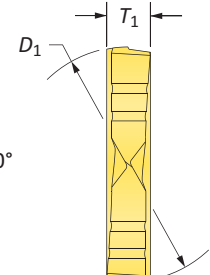
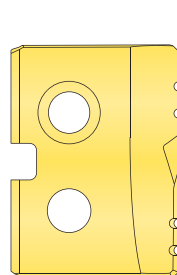

HSS Inserts – Super Cobalt

Fractional Equivalent	Insert			90° Spot & Chamfer Part No.			Flat Bottom Part No.
	D <sub>1</sub> inch	D <sub>1</sub> mm	T <sub>1</sub>	TiN	TiAlN	TiCN	TiN
7/16	0.4375	11.11	3/32	15ZT-0014-SP	15ZA-0014-SP	15ZN-0014-SP	15ZT-0014-FB
-	0.4510	11.46	3/32	15ZT-.451-SP	15ZA-.451-SP	15ZN-.451-SP	15ZT-.451-FB
-	0.4528	11.50	3/32	15ZT-11.5-SP	15ZA-11.5-SP	15ZN-11.5-SP	15ZT-11.5-FB
29/64	0.4531	11.51	3/32	15ZT-.453-SP	15ZA-.453-SP	15ZN-.453-SP	15ZT-.453-FB
15/32	0.4688	11.91	3/32	15ZT-0015-SP	15ZA-0015-SP	15ZN-0015-SP	15ZT-0015-FB
-	0.4724	12.00	3/32	15ZT-12-SP	15ZA-12-SP	15ZN-12-SP	15ZT-12-FB
31/64	0.4844	12.30	3/32	15ZT-.484-SP	15ZA-.484-SP	15ZN-.484-SP	15ZT-.484-FB
-	0.4921	12.50	3/32	15ZT-12.5-SP	15ZA-12.5-SP	15ZN-12.5-SP	15ZT-12.5-FB
1/2	0.5000	12.70	3/32	15ZT-0016-SP	15ZA-0016-SP	15ZN-0016-SP	15ZT-0016-FB
-	0.5060	12.85	3/32	15ZT-.506-SP	15ZA-.506-SP	15ZN-.506-SP	15ZT-.506-FB
-	0.5100	12.95	3/32	15ZT-.510-SP	15ZA-.510-SP	15ZN-.510-SP	15ZT-.510-FB

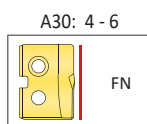
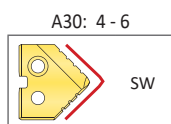
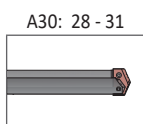
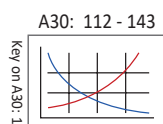

Coatings not listed above can be supplied as non-stocked standards. Process fees apply. →

TiN = 15ZT-XXXX	TiAlN = 15ZA-XXXX
TiCN = 15ZN-XXXX	AM200® = 15ZH-XXXX

Inserts sold in quantities of 2

## T-A® Drill Inserts

Z Series | Carbide | Diameter Range: 0.437" - 0.510" (11.10 mm - 12.95 mm)



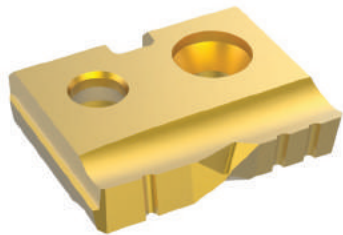
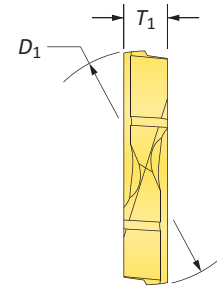
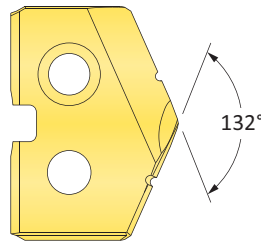

Standard

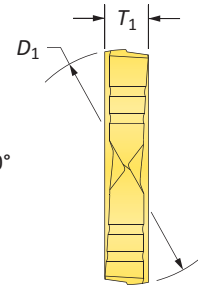
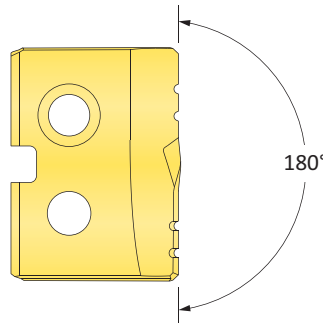

Flat Bottom



### Carbide Inserts – C2 (K20)

Fractional Equivalent	Insert			Part No.		Flat Bottom Part No.
	$D_1$ inch	$D_1$ mm	$T_1$	 TiN	 TiAlN	 TiN
7/16	0.4375	11.11	3/32	<b>1C2ZT-0014</b>	<b>1C2ZA-0014</b>	<b>1C2ZT-0014-FB</b>
-	0.4510	11.46	3/32	<b>1C2ZT-.451</b>	<b>1C2ZA-.451</b>	<b>1C2ZT-.451-FB</b>
-	0.4528	11.50	3/32	<b>1C2ZT-11.5</b>	<b>1C2ZA-11.5</b>	<b>1C2ZT-11.5-FB</b>
29/64	0.4531	11.51	3/32	<b>1C2ZT-.453</b>	<b>1C2ZA-.453</b>	<b>1C2ZT-.453-FB</b>
15/32	0.4688	11.91	3/32	<b>1C2ZT-0015</b>	<b>1C2ZA-0015</b>	<b>1C2ZT-0015-FB</b>
-	0.4724	12.00	3/32	<b>1C2ZT-12</b>	<b>1C2ZA-12</b>	<b>1C2ZT-12-FB</b>
31/64	0.4844	12.30	3/32	<b>1C2ZT-.484</b>	<b>1C2ZA-.484</b>	<b>1C2ZT-.484-FB</b>
-	0.4921	12.50	3/32	<b>1C2ZT-12.5</b>	<b>1C2ZA-12.5</b>	<b>1C2ZT-12.5-FB</b>
1/2	0.5000	12.70	3/32	<b>1C2ZT-0016</b>	<b>1C2ZA-0016</b>	<b>1C2ZT-0016-FB</b>
-	0.5060	12.85	3/32	<b>1C2ZT-.506</b>	<b>1C2ZA-.506</b>	<b>1C2ZT-.506-FB</b>
-	0.5100	12.95	3/32	<b>1C2ZT-.510</b>	<b>1C2ZA-.510</b>	<b>1C2ZT-.510-FB</b>

A30: 112 - 143

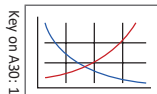

A30: 28 - 31

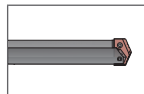

A30: 4 - 6

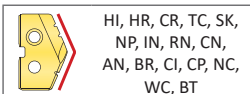

A30: 4 - 6

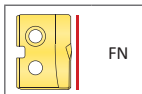

Coatings not listed above can be supplied as non-stocked standards. Process fees apply. →

TiN = 1C2ZT-XXXX

TiAlN = 1C2ZA-XXXX

TiCN = 1C2ZN-XXXX

AM200® = 1C2ZH-XXXX



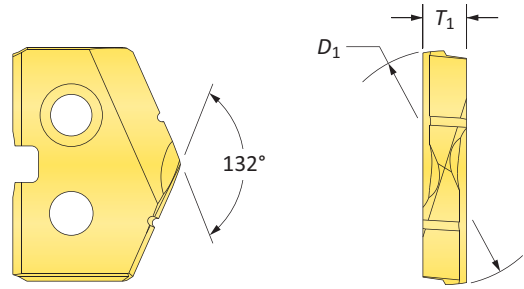
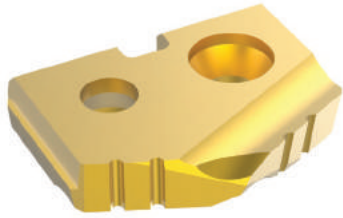

Inserts sold in quantities of 1

## T-A® Drill Inserts

Z Series | Carbide | Diameter Range: 0.437" - 0.510" (11.10 mm - 12.95 mm)



Carbide Inserts – C5 (P40) | C3 (K10) | N2

Fractional Equivalent	Insert			C5 Part No.		C3 Part No.	N2 Part No.
	D <sub>1</sub> inch	D <sub>1</sub> mm	T <sub>1</sub>	 TiN	 TiAlN	 TiAlN (Cast Iron)	 Diamond Film*
7/16	0.4375	11.11	3/32	<b>1C5ZT-0014</b>	<b>1C5ZA-0014</b>	<b>1C3ZA-0014-CI</b>	<b>1N2ZD-0014</b>
-	0.4510	11.46	3/32	<b>1C5ZT-.451</b>	<b>1C5ZA-.451</b>	<b>1C3ZA-.451-CI</b>	<b>1N2ZD-.451</b>
-	0.4528	11.50	3/32	<b>1C5ZT-11.5</b>	<b>1C5ZA-11.5</b>	<b>1C3ZA-11.5-CI</b>	<b>1N2ZD-11.5</b>
29/64	0.4531	11.51	3/32	<b>1C5ZT-.453</b>	<b>1C5ZA-.453</b>	<b>1C3ZA-.453-CI</b>	<b>1N2ZD-.453</b>
15/32	0.4688	11.91	3/32	<b>1C5ZT-0015</b>	<b>1C5ZA-0015</b>	<b>1C3ZA-0015-CI</b>	<b>1N2ZD-0015</b>
-	0.4724	12.00	3/32	<b>1C5ZT-12</b>	<b>1C5ZA-12</b>	<b>1C3ZA-12-CI</b>	<b>1N2ZD-12</b>
31/64	0.4844	12.30	3/32	<b>1C5ZT-.484</b>	<b>1C5ZA-.484</b>	<b>1C3ZA-.484-CI</b>	<b>1N2ZD-.484</b>
-	0.4921	12.50	3/32	<b>1C5ZT-12.5</b>	<b>1C5ZA-12.5</b>	<b>1C3ZA-12.5-CI</b>	<b>1N2ZD-12.5</b>
1/2	0.5000	12.70	3/32	<b>1C5ZT-0016</b>	<b>1C5ZA-0016</b>	<b>1C3ZA-0016-CI</b>	<b>1N2ZD-0016</b>
-	0.5060	12.85	3/32	<b>1C5ZT-.506</b>	<b>1C5ZA-.506</b>	<b>1C3ZA-.506-CI</b>	<b>1N2ZD-.506</b>
-	0.5100	12.95	3/32	<b>1C5ZT-.510</b>	<b>1C5ZA-.510</b>	<b>1C3ZA-.510-CI</b>	<b>1N2ZD-.510</b>

\*Diamond Film is only available in standard geometry. For additional geometries, please contact Application Engineering.

A30: 112 - 143

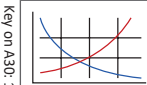

Key on A30-1

A30: 28 - 31



A30: 4 - 6



HI, HR, CR, TC, SK,  
NP, IN, RN, CN,  
AN, BR, CI, CP, NC,  
WC, BT

Coatings not listed above can be supplied as non-stocked standards. Process fees apply. →

Inserts sold in quantities of 1

<b>TiN = 1C5ZT-XXXX</b>	<b>TiAlN = 1C5ZA-XXXX</b>
<b>TiCN = 1C5ZN-XXXX</b>	<b>AM200® = 1C5ZH-XXXX</b>

## T-A® Drill Insert Holders

Z Series | Flange Shank | Diameter Range: 0.437" - 0.510" (11.10 mm - 12.95 mm)

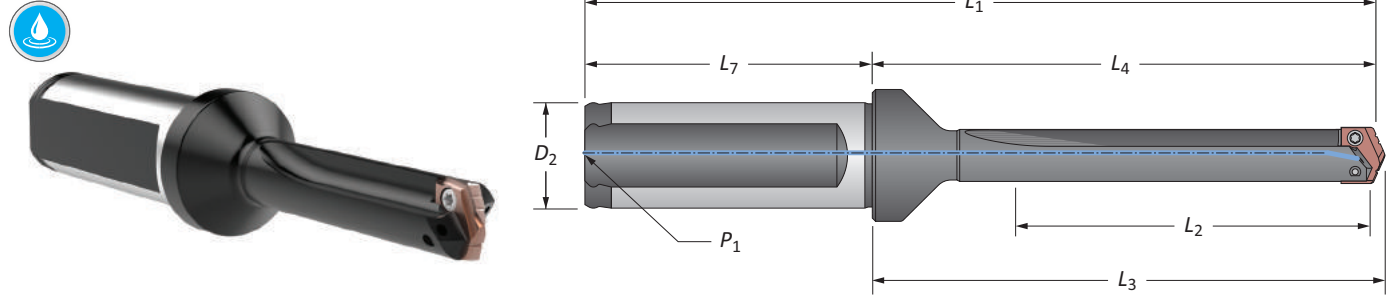

### Straight Flute

Length	Body				Shank			Part No.
	L <sub>2</sub>	L <sub>4</sub>	L <sub>3</sub>	L <sub>1</sub>	D <sub>2</sub>	L <sub>7</sub>	P <sub>1</sub>	
<b>i</b> Short	1-1/4	2-13/32	2-1/2	4-7/16	3/4	2-1/32	1/8	220Z0S-075F
<b>i</b> Standard	2-3/8	3-17/32	3-5/8	5-9/16	3/4	2-1/32	1/8	240Z0S-075F
<b>i</b> Extended	4-3/8	5-17/32	5-5/8	7-9/16	3/4	2-1/32	1/8	▲ 250Z0S-075F
<b>m</b> Short	31.8	61.1	63.5	111.1	20.0	50.0	1/8*	220Z0S-20FM
<b>m</b> XL	222.3	251.7	254.1	301.7	20.0	50.0	1/8*	▲ 270Z0S-20FM
<b>m</b> 3XL	290.5	319.9	322.3	369.9	20.0	50.0	1/8*	▲ 290Z0S-20FM

\*Metric thread to BSP and ISO 7-1

**NOTE:** Stub length holders have a 1/8" side pipe tap (P<sub>2</sub>)

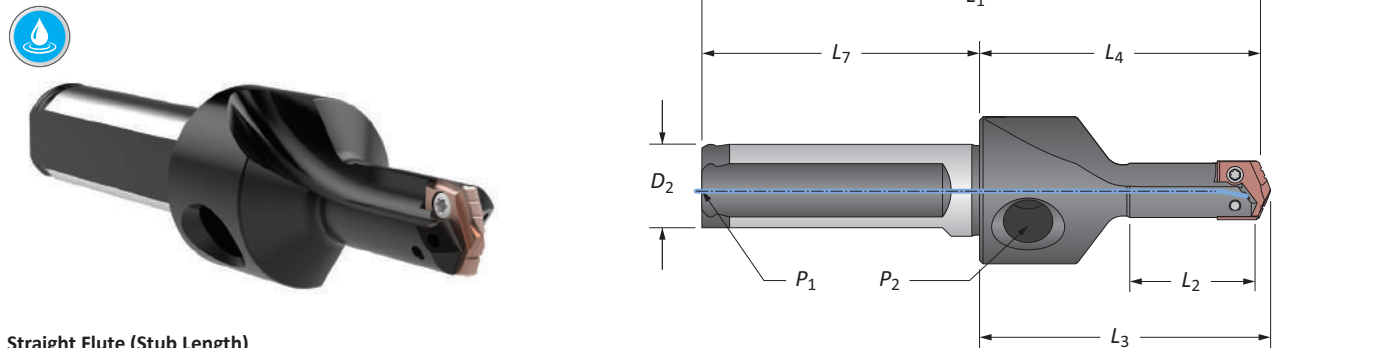

### Straight Flute (Stub Length)

Length	Body				Shank			Part No.
	L <sub>2</sub>	L <sub>4</sub>	L <sub>3</sub>	L <sub>1</sub>	D <sub>2</sub>	L <sub>7</sub>	P <sub>1</sub>	
<b>i</b> Stub	3/4	1-51/64	1-57/64	3-43/64	5/8	1-7/8	1/16	210Z0S-063F
<b>m</b> Stub	19.1	45.6	48.0	93.6	16.0	48.0	1/16*	210Z0S-16FM

\*Metric thread to BSP and ISO 7-1

**NOTE:** Stub length holders have a 1/8" side pipe tap (P<sub>2</sub>)

### Connection Accessories

Insert Screws	Nylon Locking Screws	Insert Driver	Preset Torque Hand Driver	Replacement Tips	Admissible Tightening Torque*
7247-IP7-1	7247N-IP7-1	8IP-7	8IP-7TL	8IP-7B	7.4 in-lbs (84 N-cm)

\*Tightening torques are calculated with a friction coefficient of  $\mu = 0.14$  and develop 90% of ultimate yield strength

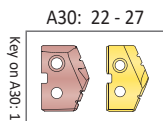

**i** = Imperial (in)  
**m** = Metric (mm)

Screws sold in quantities of 10

**WARNING** Refer to Speed and Feed charts for recommended adjustments to speeds and feeds. Refer to page A30: 146 for deep hole drilling guidelines in this section of the catalog. Visit [www.alliedmachine.com/DeepHoleGuidelines](http://www.alliedmachine.com/DeepHoleGuidelines) for the most up-to-date information and procedures. Factory technical assistance is available for your specific applications through our Application Engineering Team.

## T-A® Drill Insert Holders

Z Series | Flange Shank | Diameter Range: 0.437" - 0.510" (11.10 mm - 12.95 mm)

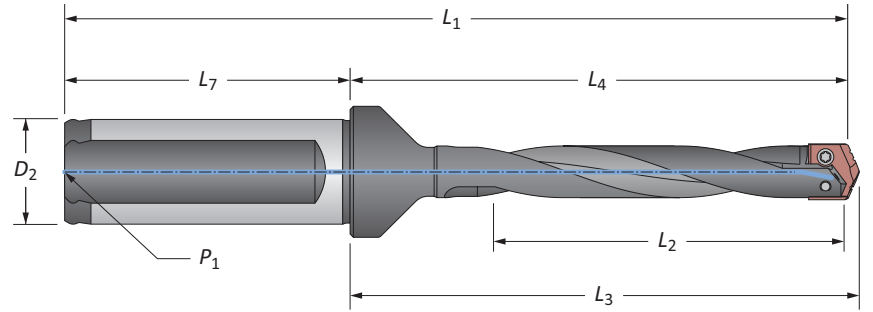

### Helical Flute

	Length	Body				Shank			Part No.
		L <sub>2</sub>	L <sub>4</sub>	L <sub>3</sub>	L <sub>1</sub>	D <sub>2</sub>	L <sub>7</sub>	P <sub>1</sub>	
i	Standard	2-3/8	3-17/32	3-5/8	5-9/16	3/4	2-1/32	1/8	240Z0H-075F
	Standard Plus	3-3/8	4-35/64	4-41/64	6-43/64	3/4	2-1/32	1/8	⚠ 245Z0H-075F
	Extended	4-3/8	5-17/32	5-5/8	7-9/16	3/4	2-1/32	1/8	⚠ 250Z0H-075F
	Long	7-1/16	8-1/4	8-11/32	10-3/8	3/4	2-1/32	1/8	⚠ 260Z0H-075F
m	Standard	60.3	89.7	92.1	139.7	20.0	50.0	1/8*	240Z0H-20FM
	Standard Plus	86.0	115.4	117.8	165.4	20.0	50.0	1/8*	⚠ 245Z0H-20FM
	Extended	111.1	140.5	142.9	190.5	20.0	50.0	1/8*	⚠ 250Z0H-20FM
	Long	180.0	209.4	211.8	259.4	20.0	50.0	1/8*	⚠ 260Z0H-20FM

\*Metric thread to BSP and ISO 7-1

### Connection Accessories

Insert Screws	Nylon Locking Screws	Insert Driver	Preset Torque Hand Driver	Replacement Tips	Admissible Tightening Torque*
7247-IP7-1	7247N-IP7-1	8IP-7	8IP-7TL	8IP-7B	7.4 in-lbs (84 N-cm)

\*Tightening torques are calculated with a friction coefficient of  $\mu = 0.14$  and develop 90% of ultimate yield strength

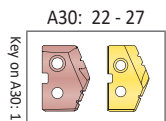

i = Imperial (in)  
m = Metric (mm)

Screws sold in quantities of 10

**⚠ WARNING** Refer to Speed and Feed charts for recommended adjustments to speeds and feeds. Refer to page A30: 146 for deep hole drilling guidelines in this section of the catalog. Visit [www.alliedmachine.com/DeepHoleGuidelines](http://www.alliedmachine.com/DeepHoleGuidelines) for the most up-to-date information and procedures. Factory technical assistance is available for your specific applications through our Application Engineering Team.

## T-A® Drill Insert Holders

Z Series | Taper Shank | Diameter Range: 0.437" - 0.510" (11.10 mm - 12.95 mm)

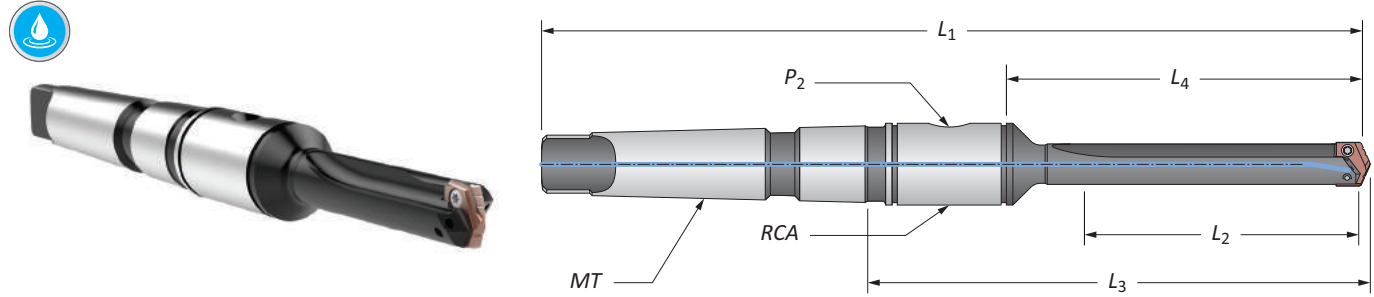

### Straight Flute

Length	Body				Shank			Part No.
	L <sub>2</sub>	L <sub>4</sub>	L <sub>3</sub>	L <sub>1</sub>	MT	P <sub>2</sub>	RCA	
Short	1-1/4	2-1/32	3-15/32	6-5/16	#2	1/16	2T-2SR	220Z0S-002I
Standard	2-3/8	3-5/32	4-19/32	7-7/16	#2	1/16	2T-2SR	240Z0S-002I
Extended	4-3/8	5-5/32	6-19/32	9-7/16	#2	1/16	2T-2SR	250Z0S-002I
Short	31.8	51.5	88.0	160.3	#2**	1/16*	2T-2SRM	220Z0S-002M

\*Metric thread to BSP and ISO 7-1

\*\*Per ISO 296 type BEK

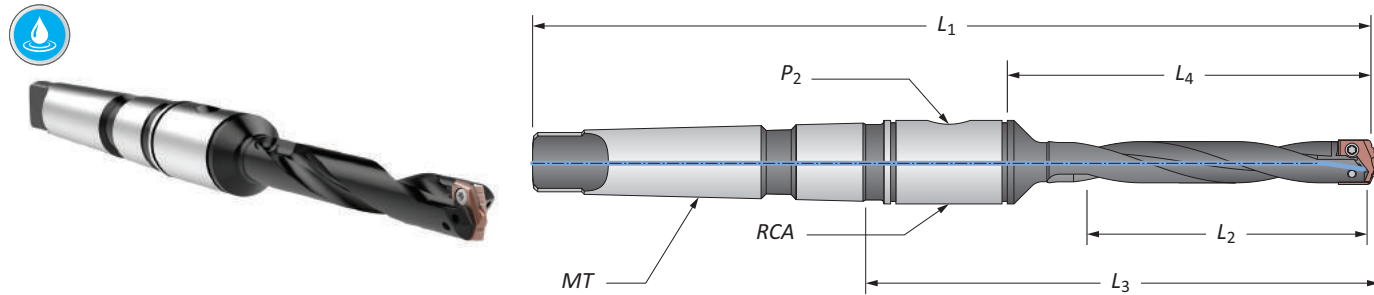

### Helical Flute

Length	Body				Shank			Part No.
	L <sub>2</sub>	L <sub>4</sub>	L <sub>3</sub>	L <sub>1</sub>	MT	P <sub>2</sub>	RCA	
Standard	2-3/8	3-5/32	4-19/32	7-7/16	#2	1/16	2T-2SR	240Z0H-002I
Extended	4-3/8	5-5/32	6-19/32	9-7/16	#2	1/16	2T-2SR	250Z0H-002I
Standard	60.3	80.2	116.7	188.9	#2**	1/16*	2T-2SRM	240Z0H-002M
Extended	111.1	130.9	167.4	239.7	#2**	1/16*	2T-2SRM	250Z0H-002M

\*Metric thread to BSP and ISO 7-1

\*\*Per ISO 296 type BEK

### Connection Accessories

Insert Screws	Nylon Locking Screws	Insert Driver	Preset Torque Hand Driver	Replacement Tips	Admissible Tightening Torque*
7247-IP7-1	7247N-IP7-1	8IP-7	8IP-7TL	8IP-7B	7.4 in-lbs (84 N-cm)

\*Tightening torques are calculated with a friction coefficient of  $\mu = 0.14$  and develop 90% of ultimate yield strength

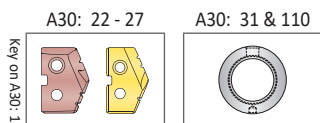

**i** = Imperial (in)

**m** = Metric (mm)

Screws sold in quantities of 10

**WARNING** Refer to Speed and Feed charts for recommended adjustments to speeds and feeds. Refer to page A30: 146 for deep hole drilling guidelines in this section of the catalog. Visit [www.alliedmachine.com/DeepHoleGuidelines](http://www.alliedmachine.com/DeepHoleGuidelines) for the most up-to-date information and procedures. Factory technical assistance is available for your specific applications through our Application Engineering Team.



## T-A® Drill Insert Holders

Z Series | Straight Shank | ER Collet | Diameter Range: 0.437" - 0.510" (11.10 mm - 12.95 mm)

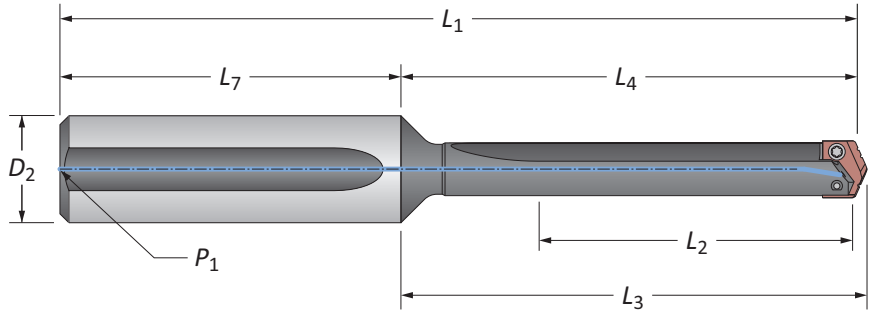

### Straight Flute

Length	Body				Shank			Part No.
	L <sub>2</sub>	L <sub>4</sub>	L <sub>3</sub>	L <sub>1</sub>	D <sub>2</sub>	L <sub>7</sub>	P <sub>1</sub>	
Short	1-1/4	2-1/32	2-1/8	4-7/16	3/4	2-3/8	1/8	220Z0S-075L
Standard	2-3/8	3-5/32	3-1/4	5-17/32	3/4	2-3/8	1/8	240Z0S-075L
Extended	4-3/8	5-5/32	5-1/4	7-17/32	3/4	2-3/8	1/8	250Z0S-075L
XL	8-3/4	9-17/32	9-5/8	11-29/32	3/4	2-3/8	1/8	270Z0S-075L
3XL	11-7/16	12-7/32	12-5/16	14-19/32	3/4	2-3/8	1/8	290Z0S-075L

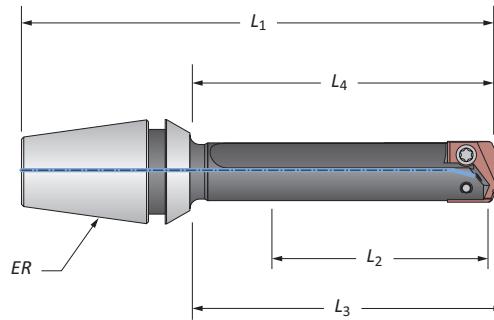

### ER Collet Holder

Length	Body				ER	Part No.	Collet Nut without Retaining Ring
	L <sub>2</sub>	L <sub>4</sub>	L <sub>3</sub>	L <sub>1</sub>			
1-3/8	1-29/32	2	3-5/64	ER-16	210Z0S-16ER	ER-16N	
1-3/8	1-29/32	2	3-15/64	ER-20	210Z0S-20ER	ER-20N	

## T-A Drill Accessories

Z Series | Rotary Coolant Adapters | Torx® Plus Screws

### Rotary Coolant Adapter (RCA) and Accessories

ID	OD	L <sub>1</sub>	Driving Rod Thread	P <sub>1</sub>	Part No.	RCA O-Rings	
						Kit Part No.**	Replacements
3/4	1-3/4	7/8	5/16-18	1/8	2T-2SR	2T1-2SR	2T1-2OR-10
19.05	44.45	22.23	M8 x 1.25	1/8*	2T-2SRM	2T1-2SR	2T1-2OR-10

\*Thread to BSP and ISO 7-1 | \*\*RCA Repair Kit includes (2) O-rings, (2) snap rings, and (2) thrust washers

▲ Refer to page A30: 110 for proper RCA assembly and safety information

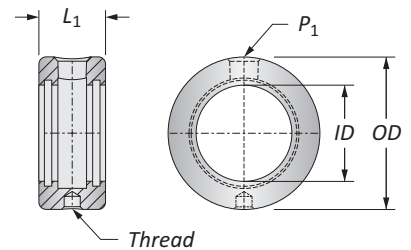

### Connection Accessories

Insert Screws	Nylon Locking Screws	Insert Driver	Preset Torque Hand Driver	Replacement Tips	Admissible Tightening Torque*
7247-IP7-1	7247N-IP7-1	8IP-7	8IP-7TL	8IP-7B	7.4 in-lbs (84 N-cm)

\*Tightening torques are calculated with a friction coefficient of  $\mu = 0.14$  and develop 90% of ultimate yield strength

**WARNING** Refer to Speed and Feed charts for recommended adjustments to speeds and feeds. Refer to page A30: 146 for deep hole drilling guidelines in this section of the catalog. Visit [www.alliedmachine.com/DeepHoleGuidelines](http://www.alliedmachine.com/DeepHoleGuidelines) for the most up-to-date information and procedures. Factory technical assistance is available for your specific applications through our Application Engineering Team.



ⓘ = Imperial (in)  
 ⓘ = Metric (mm)  
 Screws sold in packs of 10  
 O-rings sold in packs of 10

## GEN2 T-A® Drill Inserts

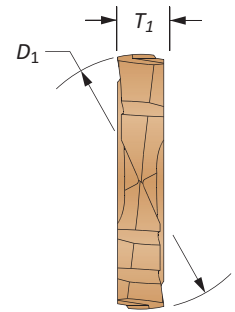
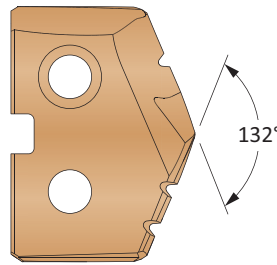
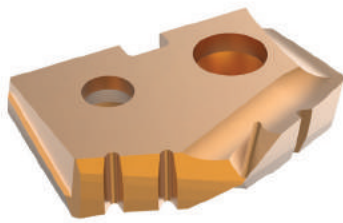
0 Series | Diameter Range: 0.511" - 0.695" (12.98 mm - 17.65 mm)



HSS Inserts – Super Cobalt • Carbide Inserts – C2 (K20) | C1 (K35)

Series	Fractional Equivalent	Insert			HSS Part No.	Carbide Part No.	
		$D_1$ inch	$D_1$ mm	$T_1$	 AM200® Super Cobalt	 AM300® C2 (K20)	 AM300® C1 (K35)
0	-	0.5118	13.00	1/8	450H-13	4C20P-13	4C10P-13
	33/64	0.5156	13.10	1/8	450H-.515	4C20P-.515	4C10P-.515
	17/32	0.5313	13.49	1/8	450H-0017	4C20P-0017	4C10P-0017
	-	0.5315	13.50	1/8	450H-13.5	4C20P-13.5	4C10P-13.5
	35/64	0.5469	13.89	1/8	450H-.546	4C20P-.546	4C10P-.546
	-	0.5512	14.00	1/8	450H-14	4C20P-14	4C10P-14
	9/16	0.5625	14.29	1/8	450H-0018	4C20P-0018	4C10P-0018
	-	0.5709	14.50	1/8	450H-14.5	4C20P-14.5	4C10P-14.5
	37/64	0.5781	14.68	1/8	450H-.578	4C20P-.578	4C10P-.578
	-	0.5906	15.00	1/8	450H-15	4C20P-15	4C10P-15
19/32	0.5938	15.08	1/8	450H-0019	4C20P-0019	4C10P-0019	
0.5	39/64	0.6094	15.48	1/8	450H-.609	4C20P-.609	4C10P-.609
	-	0.6102	15.50	1/8	450H-15.5	4C20P-15.5	4C10P-15.5
	5/8	0.6250	15.88	1/8	450H-0020	4C20P-0020	4C10P-0020
	-	0.6299	16.00	1/8	450H-16	4C20P-16	4C10P-16
	41/64	0.6406	16.27	1/8	450H-.640	4C20P-.640	4C10P-.640
	-	0.6496	16.50	1/8	450H-16.5	4C20P-16.5	4C10P-16.5
	21/32	0.6563	16.67	1/8	450H-0021	4C20P-0021	4C10P-0021
	-	0.6693	17.00	1/8	450H-17	4C20P-17	4C10P-17
	43/64	0.6719	17.07	1/8	450H-.671	4C20P-.671	4C10P-.671
	11/16	0.6875	17.46	1/8	450H-0022	4C20P-0022	4C10P-0022
-	0.6890	17.50	1/8	450H-17.5	4C20P-17.5	4C10P-17.5	

**NOTE:** 0.5 series inserts fit into both 0 and 0.5 series holders. However, 0 series inserts ONLY fit into 0 series holders. See page A30: 7 for visual.

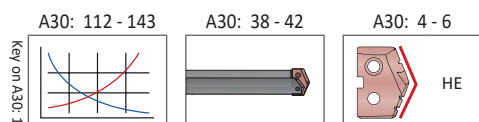

Inserts sold in quantities of 2

Coatings not listed above can be supplied as non-stocked standards. Process fees apply. →

TiN = 450T-XXXX	TiAlN = 450A-XXXX
TiCN = 450N-XXXX	AM200® = 450H-XXXX





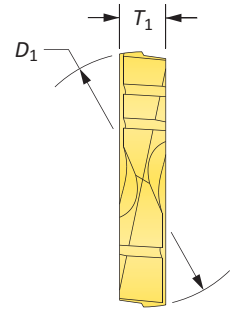
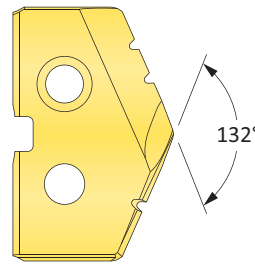
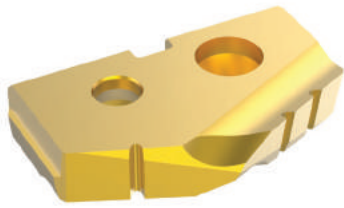

T-A® Drill Inserts

0 Series | HSS | Diameter Range: 0.511" - 0.695" (12.98 mm - 17.65 mm)



HSS Inserts – Premium Cobalt

Series	Fractional Equivalent	Insert			Part No.		
		D <sub>1</sub> inch	D <sub>1</sub> mm	T <sub>1</sub>	 TiN	 TiAlN	 TiCN
0	–	0.5118	13.00	1/8	<b>180T-13</b>	<b>180A-13</b>	<b>180N-13</b>
	33/64	0.5156	13.10	1/8	<b>180T-.515</b>	<b>180A-.515</b>	<b>180N-.515</b>
	17/32	0.5313	13.49	1/8	<b>180T-0017</b>	<b>180A-0017</b>	<b>180N-0017</b>
	–	0.5315	13.50	1/8	<b>180T-13.5</b>	<b>180A-13.5</b>	<b>180N-13.5</b>
	35/64	0.5469	13.89	1/8	<b>180T-.546</b>	<b>180A-.546</b>	<b>180N-.546</b>
	–	0.5512	14.00	1/8	<b>180T-14</b>	<b>180A-14</b>	<b>180N-14</b>
	9/16	0.5625	14.29	1/8	<b>180T-0018</b>	<b>180A-0018</b>	<b>180N-0018</b>
	–	0.5709	14.50	1/8	<b>180T-14.5</b>	<b>180A-14.5</b>	<b>180N-14.5</b>
	37/64	0.5781	14.68	1/8	<b>180T-.578</b>	<b>180A-.578</b>	<b>180N-.578</b>
0.5	–	0.5906	15.00	1/8	<b>180T-15</b>	<b>180A-15</b>	<b>180N-15</b>
	19/32	0.5938	15.08	1/8	<b>180T-0019</b>	<b>180A-0019</b>	<b>180N-0019</b>
	39/64	0.6094	15.48	1/8	<b>180T-.609</b>	<b>180A-.609</b>	<b>180N-.609</b>
	–	0.6102	15.50	1/8	<b>180T-15.5</b>	<b>180A-15.5</b>	<b>180N-15.5</b>
	5/8	0.6250	15.88	1/8	<b>180T-0020</b>	<b>180A-0020</b>	<b>180N-0020</b>
	–	0.6299	16.00	1/8	<b>180T-16</b>	<b>180A-16</b>	<b>180N-16</b>
	41/64	0.6406	16.27	1/8	<b>180T-.640</b>	<b>180A-.640</b>	<b>180N-.640</b>
	–	0.6496	16.50	1/8	<b>180T-16.5</b>	<b>180A-16.5</b>	<b>180N-16.5</b>
	21/32	0.6563	16.67	1/8	<b>180T-0021</b>	<b>180A-0021</b>	<b>180N-0021</b>
	–	0.6693	17.00	1/8	<b>180T-17</b>	<b>180A-17</b>	<b>180N-17</b>
	43/64	0.6719	17.07	1/8	<b>180T-.671</b>	<b>180A-.671</b>	<b>180N-.671</b>
	11/16	0.6875	17.46	1/8	<b>180T-0022</b>	<b>180A-0022</b>	<b>180N-0022</b>
–	0.6890	17.50	1/8	<b>180T-17.5</b>	<b>180A-17.5</b>	<b>180N-17.5</b>	

NOTE: 0.5 series inserts fit into both 0 and 0.5 series holders. However, 0 series inserts ONLY fit into 0 series holders. See page A30: 7 for visual.

A30: 112 - 143

A30: 38 - 42

A30: 4 - 6

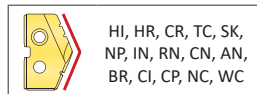
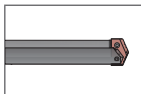
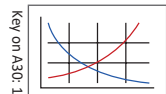

Coatings not listed above can be supplied as non-stocked standards. Process fees apply. →

Inserts sold in quantities of 2



<b>TiN = 180T-XXXX</b>	<b>TiAlN = 180A-XXXX</b>
<b>TiCN = 180N-XXXX</b>	<b>AM200® = 180H-XXXX</b>

## T-A® Drill Inserts

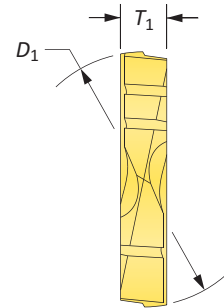
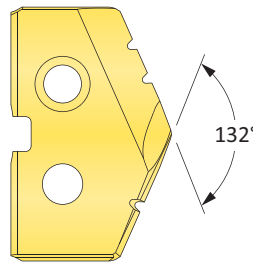
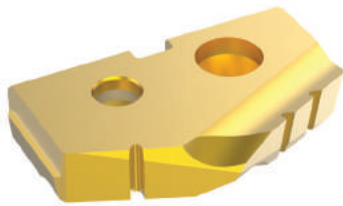
0 Series | HSS | Diameter Range: 0.511" - 0.695" (12.98 mm - 17.65 mm)



### HSS Inserts – Super Cobalt

Series	Fractional Equivalent	Insert			Part No.		
		$D_1$ inch	$D_1$ mm	$T_1$	 TiN	 TiAlN	 TiCN
0	-	0.5118	13.00	1/8	150T-13	150A-13	150N-13
	33/64	0.5156	13.10	1/8	150T-.515	150A-.515	150N-.515
	17/32	0.5313	13.49	1/8	150T-0017	150A-0017	150N-0017
	-	0.5315	13.50	1/8	150T-13.5	150A-13.5	150N-13.5
	35/64	0.5469	13.89	1/8	150T-.546	150A-.546	150N-.546
	-	0.5512	14.00	1/8	150T-14	150A-14	150N-14
	9/16	0.5625	14.29	1/8	150T-0018	150A-0018	150N-0018
	-	0.5709	14.50	1/8	150T-14.5	150A-14.5	150N-14.5
	37/64	0.5781	14.68	1/8	150T-.578	150A-.578	150N-.578
	-	0.5906	15.00	1/8	150T-15	150A-15	150N-15
19/32	0.5938	15.08	1/8	150T-0019	150A-0019	150N-0019	
0.5	39/64	0.6094	15.48	1/8	150T-.609	150A-.609	150N-.609
	-	0.6102	15.50	1/8	150T-15.5	150A-15.5	150N-15.5
	5/8	0.6250	15.88	1/8	150T-0020	150A-0020	150N-0020
	-	0.6299	16.00	1/8	150T-16	150A-16	150N-16
	41/64	0.6406	16.27	1/8	150T-.640	150A-.640	150N-.640
	-	0.6496	16.50	1/8	150T-16.5	150A-16.5	150N-16.5
	21/32	0.6563	16.67	1/8	150T-0021	150A-0021	150N-0021
	-	0.6693	17.00	1/8	150T-17	150A-17	150N-17
	43/64	0.6719	17.07	1/8	150T-.671	150A-.671	150N-.671
	11/16	0.6875	17.46	1/8	150T-0022	150A-0022	150N-0022
-	0.6890	17.50	1/8	150T-17.5	150A-17.5	150N-17.5	

**NOTE:** 0.5 series inserts fit into both 0 and 0.5 series holders. However, 0 series inserts ONLY fit into 0 series holders. See page A30: 7 for visual.

Inserts sold in quantities of 2

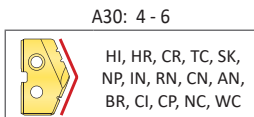
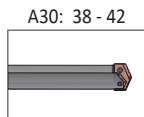
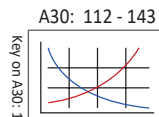

Coatings not listed above  
can be supplied as  
non-stocked standards.  
Process fees apply. →



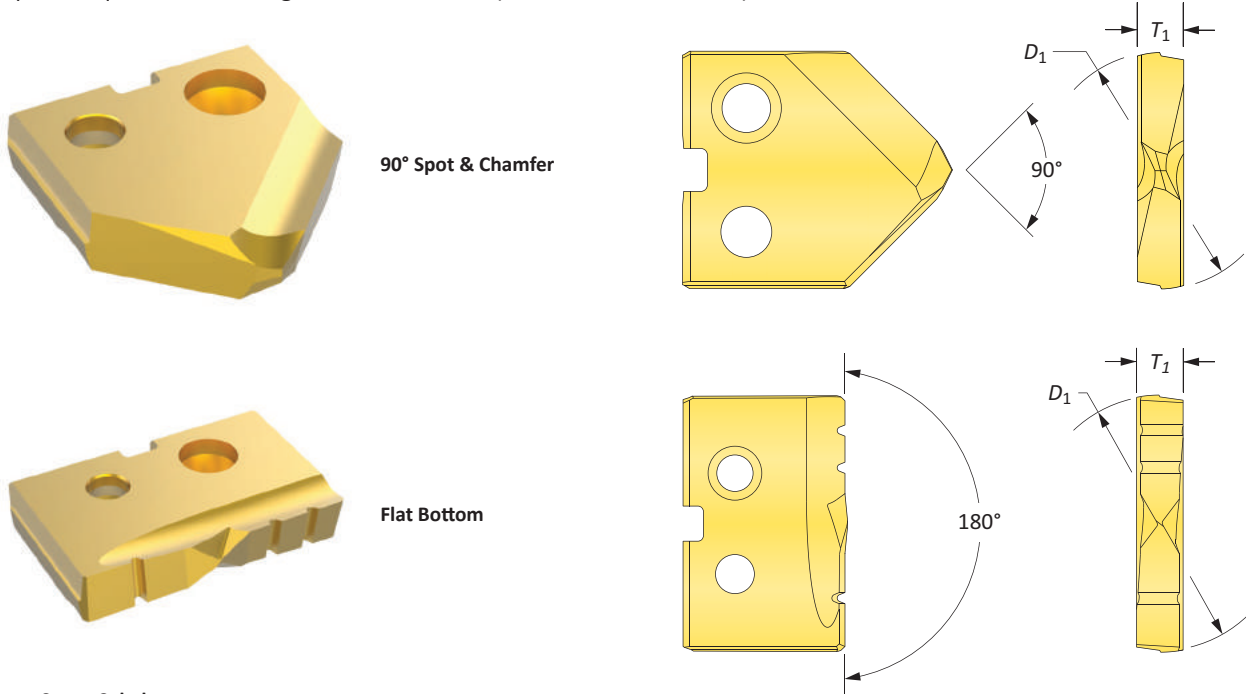

TiN = 150T-XXXX	TiAlN = 150A-XXXX
TiCN = 150N-XXXX	AM200® = 150H-XXXX

**T-A® Drill Inserts**

0 Series | HSS | Diameter Range: 0.511" - 0.695" (12.98 mm - 17.65 mm)



**HSS Inserts – Super Cobalt**

Series	Insert				90° Spot & Chamfer Part No.			Flat Bottom Part No.
	Fractional Equivalent	D <sub>1</sub> inch	D <sub>1</sub> mm	T <sub>1</sub>	 TIN	 TiAlN	 TiCN	 TIN
0	-	0.5118	13.00	1/8	150T-13-SP	150A-13-SP	150N-13-SP	150T-13-FB
	33/64	0.5156	13.10	1/8	150T-515-SP	150A-515-SP	150N-515-SP	150T-515-FB
	17/32	0.5313	13.49	1/8	150T-0017-SP	150A-0017-SP	150N-0017-SP	150T-0017-FB
	-	0.5315	13.50	1/8	150T-13.5-SP	150A-13.5-SP	150N-13.5-SP	150T-13.5-FB
	35/64	0.5469	13.89	1/8	150T-546-SP	150A-546-SP	150N-546-SP	150T-546-FB
	-	0.5512	14.00	1/8	150T-14-SP	150A-14-SP	150N-14-SP	150T-14-FB
	9/16	0.5625	14.29	1/8	150T-0018-SP	150A-0018-SP	150N-0018-SP	150T-0018-FB
	-	0.5709	14.50	1/8	150T-14.5-SP	150A-14.5-SP	150N-14.5-SP	150T-14.5-FB
	37/64	0.5781	14.68	1/8	150T-578-SP	150A-578-SP	150N-578-SP	150T-578-FB
0.5	-	0.5906	15.00	1/8	150T-15-SP	150A-15-SP	150N-15-SP	150T-15-FB
	19/32	0.5938	15.08	1/8	150T-0019-SP	150A-0019-SP	150N-0019-SP	150T-0019-FB
	39/64	0.6094	15.48	1/8	150T-609-SP	150A-609-SP	150N-609-SP	150T-609-FB
	-	0.6102	15.50	1/8	150T-15.5-SP	150A-15.5-SP	150N-15.5-SP	150T-15.5-FB
	5/8	0.6250	15.88	1/8	150T-0020-SP	150A-0020-SP	150N-0020-SP	150T-0020-FB
	-	0.6299	16.00	1/8	150T-16-SP	150A-16-SP	150N-16-SP	150T-16-FB
	41/64	0.6406	16.27	1/8	150T-640-SP	150A-640-SP	150N-640-SP	150T-640-FB
	-	0.6496	16.50	1/8	150T-16.5-SP	150A-16.5-SP	150N-16.5-SP	150T-16.5-FB
	21/32	0.6563	16.67	1/8	150T-0021-SP	150A-0021-SP	150N-0021-SP	150T-0021-FB
	-	0.6693	17.00	1/8	150T-17-SP	150A-17-SP	150N-17-SP	150T-17-FB
0.5	43/64	0.6719	17.07	1/8	150T-671-SP	150A-671-SP	150N-671-SP	150T-671-FB
	11/16	0.6875	17.46	1/8	150T-0022-SP	150A-0022-SP	150N-0022-SP	150T-0022-FB
	-	0.6890	17.50	1/8	150T-17.5-SP	150A-17.5-SP	150N-17.5-SP	150T-17.5-FB

**NOTE:** 0.5 series inserts fit into both 0 and 0.5 series holders. However, 0 series inserts ONLY fit into 0 series holders. See page A30: 7 for visual.

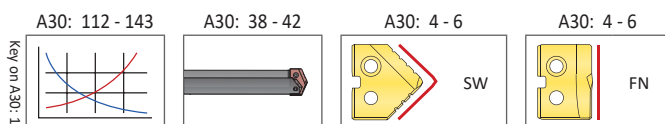

Coatings not listed above can be supplied as non-stocked standards. Process fees apply. →

TiN = 150T-XXXX	TiAlN = 150A-XXXX
TiCN = 150N-XXXX	AM200® = 150H-XXXX

Inserts sold in quantities of 2

### T-A® Drill Inserts

0 Series | Carbide | Diameter Range: 0.511" - 0.695" (12.98 mm - 17.65 mm)

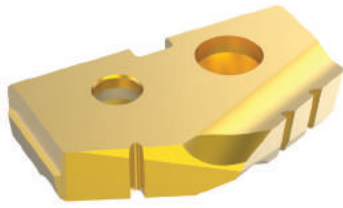

Standard

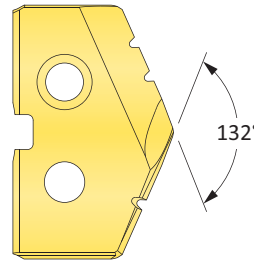

132°

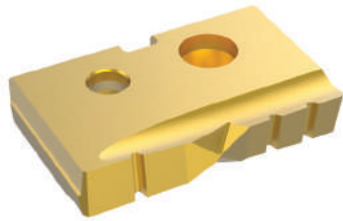
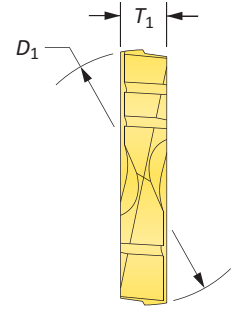

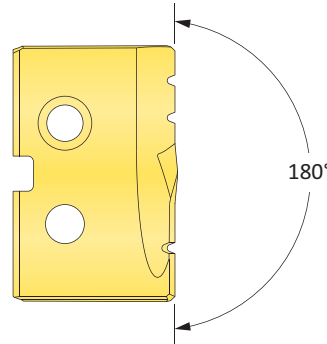

Flat Bottom

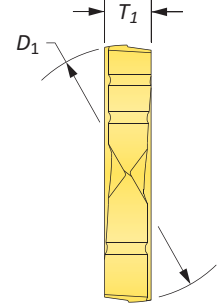

180°



#### Carbide Inserts – C2 (K20)

Series	Fractional Equivalent	Insert			Part No.		Flat Bottom Part No.
		D <sub>1</sub> inch	D <sub>1</sub> mm	T <sub>1</sub>	 TiN	 TiAlN	 TiN
0	-	0.5118	13.00	1/8	<b>1C20T-13</b>	<b>1C20A-13</b>	<b>1C20T-13-FB</b>
	33/64	0.5156	13.10	1/8	<b>1C20T-.515</b>	<b>1C20A-.515</b>	<b>1C20T-.515-FB</b>
	17/32	0.5313	13.49	1/8	<b>1C20T-0017</b>	<b>1C20A-0017</b>	<b>1C20T-0017-FB</b>
	-	0.5315	13.50	1/8	<b>1C20T-13.5</b>	<b>1C20A-13.5</b>	<b>1C20T-13.5-FB</b>
	35/64	0.5469	13.89	1/8	<b>1C20T-.546</b>	<b>1C20A-.546</b>	<b>1C20T-.546-FB</b>
	-	0.5512	14.00	1/8	<b>1C20T-14</b>	<b>1C20A-14</b>	<b>1C20T-14-FB</b>
	9/16	0.5625	14.29	1/8	<b>1C20T-0018</b>	<b>1C20A-0018</b>	<b>1C20T-0018-FB</b>
	-	0.5709	14.50	1/8	<b>1C20T-14.5</b>	<b>1C20A-14.5</b>	<b>1C20T-14.5-FB</b>
	37/64	0.5781	14.68	1/8	<b>1C20T-.578</b>	<b>1C20A-.578</b>	<b>1C20T-.578-FB</b>
	-	0.5906	15.00	1/8	<b>1C20T-15</b>	<b>1C20A-15</b>	<b>1C20T-15-FB</b>
19/32	0.5938	15.08	1/8	<b>1C20T-0019</b>	<b>1C20A-0019</b>	<b>1C20T-0019-FB</b>	
0.5	39/64	0.6094	15.48	1/8	<b>1C20T-.609</b>	<b>1C20A-.609</b>	<b>1C20T-.609-FB</b>
	-	0.6102	15.50	1/8	<b>1C20T-15.5</b>	<b>1C20A-15.5</b>	<b>1C20T-15.5-FB</b>
	5/8	0.6250	15.88	1/8	<b>1C20T-0020</b>	<b>1C20A-0020</b>	<b>1C20T-0020-FB</b>
	-	0.6299	16.00	1/8	<b>1C20T-16</b>	<b>1C20A-16</b>	<b>1C20T-16-FB</b>
	41/64	0.6406	16.27	1/8	<b>1C20T-.640</b>	<b>1C20A-.640</b>	<b>1C20T-.640-FB</b>
	-	0.6496	16.50	1/8	<b>1C20T-16.5</b>	<b>1C20A-16.5</b>	<b>1C20T-16.5-FB</b>
	21/32	0.6563	16.67	1/8	<b>1C20T-0021</b>	<b>1C20A-0021</b>	<b>1C20T-0021-FB</b>
	-	0.6693	17.00	1/8	<b>1C20T-17</b>	<b>1C20A-17</b>	<b>1C20T-17-FB</b>
	43/64	0.6719	17.07	1/8	<b>1C20T-.671</b>	<b>1C20A-.671</b>	<b>1C20T-.671-FB</b>
	11/16	0.6875	17.46	1/8	<b>1C20T-0022</b>	<b>1C20A-0022</b>	<b>1C20T-0022-FB</b>
-	0.6890	17.50	1/8	<b>1C20T-17.5</b>	<b>1C20A-17.5</b>	<b>1C20T-17.5-FB</b>	

**NOTE:** 0.5 series inserts fit into both 0 and 0.5 series holders. However, 0 series inserts ONLY fit into 0 series holders. See page A30: 7 for visual.

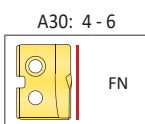
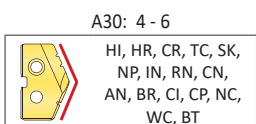
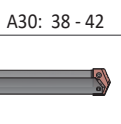
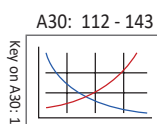

Coatings not listed above can be supplied as non-stocked standards. Process fees apply. →

TiN = 1C20T-XXXX	TiAlN = 1C20A-XXXX
TiCN = 1C20N-XXXX	AM200® = 1C20H-XXXX

Inserts sold in quantities of 1



T-A® Drill Inserts

0 Series | Carbide | Diameter Range: 0.511" - 0.695" (12.98 mm - 17.65 mm)

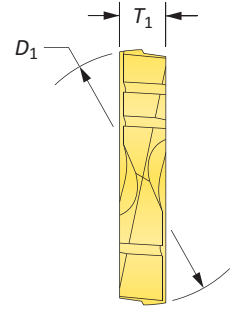
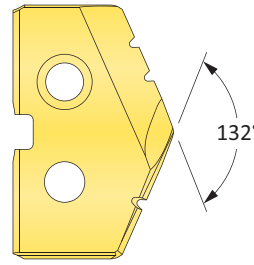
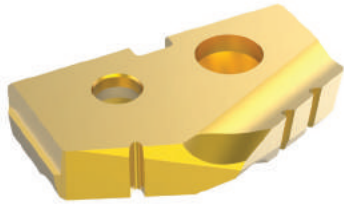

Carbide Inserts – C5 (P40) | C3 (K10) | N2

Series	Insert				C5 Part No.		C3 Part No.	N2 Part No.
	Fractional Equivalent	D <sub>1</sub> inch	D <sub>1</sub> mm	T <sub>1</sub>	TiN	TiAlN	TiAlN (Cast Iron)	Diamond Film*
0	-	0.5118	13.00	1/8	<b>1C50T-13</b>	<b>1C50A-13</b>	<b>1C30A-13-CI</b>	<b>1N20D-13</b>
	33/64	0.5156	13.10	1/8	<b>1C50T-.515</b>	<b>1C50A-.515</b>	<b>1C30A-.515-CI</b>	<b>1N20D-.515</b>
	17/32	0.5313	13.49	1/8	<b>1C50T-0017</b>	<b>1C50A-0017</b>	<b>1C30A-0017-CI</b>	<b>1N20D-0017</b>
	-	0.5315	13.50	1/8	<b>1C50T-13.5</b>	<b>1C50A-13.5</b>	<b>1C30A-13.5-CI</b>	<b>1N20D-13.5</b>
	35/64	0.5469	13.89	1/8	<b>1C50T-.546</b>	<b>1C50A-.546</b>	<b>1C30A-.546-CI</b>	<b>1N20D-.546</b>
	-	0.5512	14.00	1/8	<b>1C50T-14</b>	<b>1C50A-14</b>	<b>1C30A-14-CI</b>	<b>1N20D-14</b>
	9/16	0.5625	14.29	1/8	<b>1C50T-0018</b>	<b>1C50A-0018</b>	<b>1C30A-0018-CI</b>	<b>1N20D-0018</b>
	-	0.5709	14.50	1/8	<b>1C50T-14.5</b>	<b>1C50A-14.5</b>	<b>1C30A-14.5-CI</b>	<b>1N20D-14.5</b>
	37/64	0.5781	14.68	1/8	<b>1C50T-.578</b>	<b>1C50A-.578</b>	<b>1C30A-.578-CI</b>	<b>1N20D-.578</b>
	-	0.5906	15.00	1/8	<b>1C50T-15</b>	<b>1C50A-15</b>	<b>1C30A-15-CI</b>	<b>1N20D-15</b>
19/32	0.5938	15.08	1/8	<b>1C50T-0019</b>	<b>1C50A-0019</b>	<b>1C30A-0019-CI</b>	<b>1N20D-0019</b>	
0.5	39/64	0.6094	15.48	1/8	<b>1C50T-.609</b>	<b>1C50A-.609</b>	<b>1C30A-.609-CI</b>	<b>1N20D-.609</b>
	-	0.6102	15.50	1/8	<b>1C50T-15.5</b>	<b>1C50A-15.5</b>	<b>1C30A-15.5-CI</b>	<b>1N20D-15.5</b>
	5/8	0.6250	15.88	1/8	<b>1C50T-0020</b>	<b>1C50A-0020</b>	<b>1C30A-0020-CI</b>	<b>1N20D-0020</b>
	-	0.6299	16.00	1/8	<b>1C50T-16</b>	<b>1C50A-16</b>	<b>1C30A-16-CI</b>	<b>1N20D-16</b>
	41/64	0.6406	16.27	1/8	<b>1C50T-.640</b>	<b>1C50A-.640</b>	<b>1C30A-.640-CI</b>	<b>1N20D-.640</b>
	-	0.6496	16.50	1/8	<b>1C50T-16.5</b>	<b>1C50A-16.5</b>	<b>1C30A-16.5-CI</b>	<b>1N20D-16.5</b>
	21/32	0.6563	16.67	1/8	<b>1C50T-0021</b>	<b>1C50A-0021</b>	<b>1C30A-0021-CI</b>	<b>1N20D-0021</b>
	-	0.6693	17.00	1/8	<b>1C50T-17</b>	<b>1C50A-17</b>	<b>1C30A-17-CI</b>	<b>1N20D-17</b>
	43/64	0.6719	17.07	1/8	<b>1C50T-.671</b>	<b>1C50A-.671</b>	<b>1C30A-.671-CI</b>	<b>1N20D-.671</b>
	11/16	0.6875	17.46	1/8	<b>1C50T-0022</b>	<b>1C50A-0022</b>	<b>1C30A-0022-CI</b>	<b>1N20D-0022</b>
-	0.6890	17.50	1/8	<b>1C50T-17.5</b>	<b>1C50A-17.5</b>	<b>1C30A-17.5-CI</b>	<b>1N20D-17.5</b>	

**NOTE:** 0.5 series inserts fit into both 0 and 0.5 series holders. However, 0 series inserts ONLY fit into 0 series holders. See page A30: 7 for visual.

\*Diamond Film is only available in standard geometry. For additional geometries, please contact Application Engineering.

A30: 112 - 143

A30: 38 - 42

A30: 4 - 6

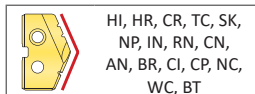
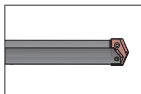
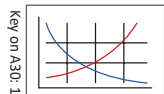

HI, HR, CR, TC, SK,  
NP, IN, RN, CN,  
AN, BR, CI, CP, NC,  
WC, BT

Coatings not listed above can be supplied as non-stocked standards. Process fees apply. →

Inserts sold in quantities of 1

TiN = 1C50T-XXXX	TiAlN = 1C50A-XXXX
TiCN = 1C50N-XXXX	AM200® = 1C50H-XXXX

## T-A® Drill Insert Holders

0 Series | Flange Shank | Diameter Range: 0.511" - 0.695" (12.98 mm - 17.65 mm)

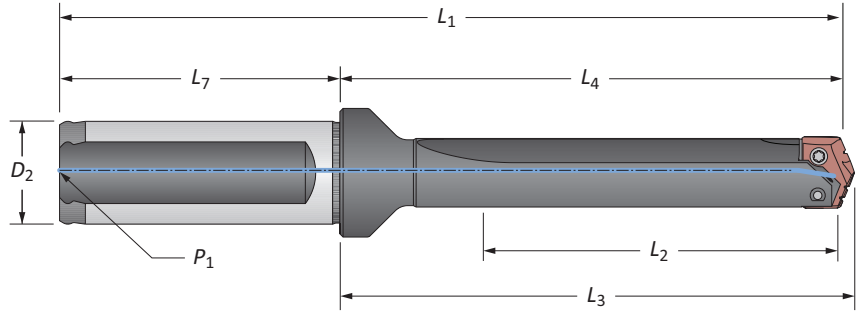

Stub Length

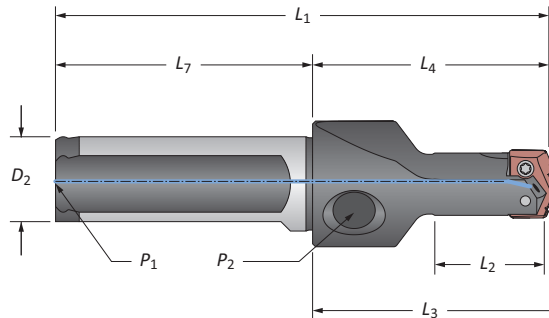

### Straight Flute

Series	Length	Body				Shank			Part No.	
		L <sub>2</sub>	L <sub>4</sub>	L <sub>3</sub>	L <sub>1</sub>	D <sub>2</sub>	L <sub>7</sub>	P <sub>1</sub>		
0	Stub	7/8	1-7/8	1-63/64	3-29/32	3/4	2-1/32	1/8	21000S-075F	
	Short	1-3/8	2-1/2	2-39/64	4-17/32	3/4	2-1/32	1/8	22000S-075F	
	Standard	2-1/2	3-5/8	3-47/64	5-21/32	3/4	2-1/32	1/8	24000S-075F	
	Extended	4-1/2	5-5/8	5-47/64	7-21/32	3/4	2-1/32	1/8	▲ 25000S-075F	
0.5	Stub	7/8	1-7/8	1-63/64	3-29/32	3/4	2-1/32	1/8	21005S-075F	
	Short	1-3/8	2-1/2	2-39/64	4-17/32	3/4	2-1/32	1/8	22005S-075F	
	Standard	2-1/2	3-5/8	3-47/64	5-21/32	3/4	2-1/32	1/8	24005S-075F	
	Extended	4-1/2	5-5/8	5-47/64	7-21/32	3/4	2-1/32	1/8	▲ 25005S-075F	
0	Stub	22.2	47.6	50.4	97.6	20.0	50.0	1/8*	21000S-20FM	
	Short	34.9	63.5	66.3	113.5	20.0	50.0	1/8*	22000S-20FM	
	XL	295.0	323.9	326.7	373.9	20.0	50.0	1/8*	▲ 27000S-20FM	
	3XL	387.0	416.0	418.8	466.0	20.0	50.0	1/8*	▲ 29000S-20FM	
	0.5	Stub	22.2	47.6	50.4	97.6	20.0	50.0	1/8*	21005S-20FM
		Short	34.9	63.5	66.3	113.5	20.0	50.0	1/8*	22005S-20FM

\*Metric thread to BSP and ISO 7-1

**NOTE:** Stub length holders have a 1/8" side pipe tap (P<sub>2</sub>)

**NOTE:** 0.5 series inserts fit into both 0 and 0.5 series holders. However, 0 series inserts ONLY fit into 0 series holders. See page A30: 7 for visual.

### Connection Accessories

Series	Insert Screws	Nylon Locking Screws	Insert Driver	Preset Torque Hand Driver	Replacement Tips	Admissible Tightening Torque*
0	72556-IP8-1	72556N-IP8-1	8IP-8	8IP-8TL	8IP-8B	15.5 in-lbs (175 N-cm)
0.5	72567-IP8-1	72567N-IP8-1	8IP-8	8IP-8TL	8IP-8B	15.5 in-lbs (175 N-cm)

\*Tightening torques are calculated with a friction coefficient of  $\mu = 0.14$  and develop 90% of ultimate yield strength

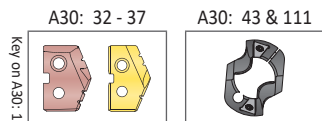

Key on A30: 1

i = Imperial (in)  
m = Metric (mm)

Screws sold in quantities of 10

**WARNING** Refer to Speed and Feed charts for recommended adjustments to speeds and feeds. Refer to page A30: 146 for deep hole drilling guidelines in this section of the catalog. Visit [www.alliedmachine.com/DeepHoleGuidelines](http://www.alliedmachine.com/DeepHoleGuidelines) for the most up-to-date information and procedures. Factory technical assistance is available for your specific applications through our Application Engineering Team.



## T-A® Drill Insert Holders

0 Series | Flange Shank | Diameter Range: 0.511" - 0.695" (12.98 mm - 17.65 mm)

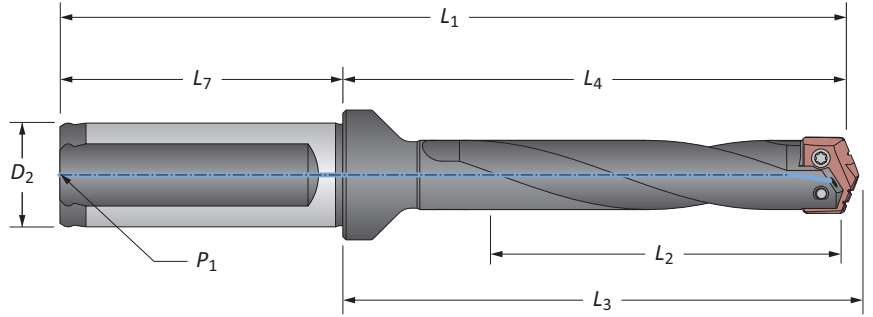

### Helical Flute

Series	Length	Body				Shank			Part No.
		L <sub>2</sub>	L <sub>4</sub>	L <sub>3</sub>	L <sub>1</sub>	D <sub>2</sub>	L <sub>7</sub>	P <sub>1</sub>	
i	Standard	2-1/2	3-5/8	3-47/64	5-21/32	3/4	2-1/32	1/8	24000H-075F
	Standard Plus	3-1/2	4-5/8	4-37/64	6-39/64	3/4	2-1/32	1/8	⚠ 24500H-075F
	Extended	4-1/2	5-5/8	5-47/64	7-21/32	3/4	2-1/32	1/8	⚠ 25000H-075F
	Long	7	8-1/8	8-15/64	10-5/32	3/4	2-1/32	1/8	⚠ 26000H-075F
	Long Plus	9-7/16	10-37/64	10-11/16	12-23/32	3/4	2-1/32	1/8	⚠ 26500H-075F
0.5	Standard	2-1/2	3-5/8	3-47/64	5-21/32	3/4	2-1/32	1/8	24005H-075F
	Extended	4-1/2	5-5/8	5-47/64	7-21/32	3/4	2-1/32	1/8	⚠ 25005H-075F
	Long	7	8-1/8	8-15/64	10-5/32	3/4	2-1/32	1/8	⚠ 26005H-075F
ii	Standard	63.5	92.1	94.9	142.1	20.0	50.0	1/8*	24000H-20FM
	Standard Plus	89.0	117.6	120.4	167.6	20.0	50.0	1/8*	⚠ 24500H-20FM
	Extended	114.3	142.9	145.7	192.9	20.0	50.0	1/8*	⚠ 25000H-20FM
	Long	177.8	206.4	209.1	256.4	20.0	50.0	1/8*	⚠ 26000H-20FM
	Long Plus	240.0	268.6	271.4	318.6	20.0	50.0	1/8*	⚠ 26500H-20FM
	Standard	63.5	92.1	94.9	142.1	20.0	50.0	1/8*	24005H-20FM
	Extended	114.3	142.9	145.7	192.9	20.0	50.0	1/8*	⚠ 25005H-20FM
	Long	177.8	206.4	209.1	256.4	20.0	50.0	1/8*	⚠ 26005H-20FM

\*Metric thread to BSP and ISO 7-1NTE: 0.5 hold)

**NOTE:** 0.5 series inserts fit into both 0 and 0.5 series holders. However, 0 series inserts ONLY fit into 0 series holders. See page A30: 7 for visual.

### Connection Accessories

Series	Insert Screws	Nylon Locking Screws	Insert Driver	Preset Torque Hand Driver	Replacement Tips	Admissible Tightening Torque*
0	72556-IP8-1	72556N-IP8-1	8IP-8	8IP-8TL	8IP-8B	15.5 in-lbs (175 N-cm)
0.5	72567-IP8-1	72567N-IP8-1	8IP-8	8IP-8TL	8IP-8B	15.5 in-lbs (175 N-cm)

\*Tightening torques are calculated with a friction coefficient of  $\mu = 0.14$  and develop 90% of ultimate yield strength

A30: 32 - 37

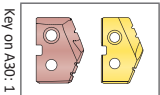

i = Imperial (in)  
m = Metric (mm)

Screws sold in quantities of 10

**⚠ WARNING** Refer to Speed and Feed charts for recommended adjustments to speeds and feeds. Refer to page A30: 146 for deep hole drilling guidelines in this section of the catalog. Visit [www.alliedmachine.com/DeepHoleGuidelines](http://www.alliedmachine.com/DeepHoleGuidelines) for the most up-to-date information and procedures. Factory technical assistance is available for your specific applications through our Application Engineering Team.

## T-A Drill Insert Holders

0 Series | Taper Shank | Diameter Range: 0.511" - 0.695" (12.98 mm - 17.65 mm)

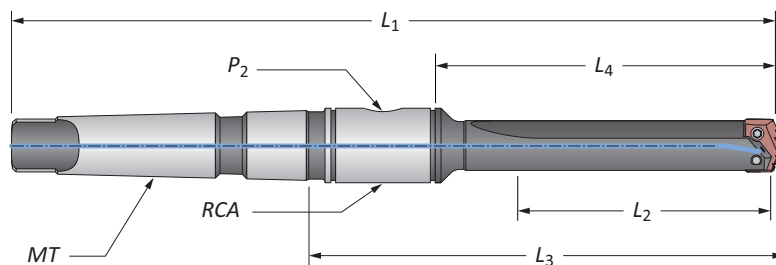

### Straight Flute

Series	Length	Body				Shank			Part No.
		L <sub>2</sub>	L <sub>4</sub>	L <sub>3</sub>	L <sub>1</sub>	MT	P <sub>2</sub>	RCA	
i 0	Short	1-3/8	2-3/16	3-15/32	6-15/32	#2	1/16	2T-2SR	22000S-002I
	Standard	2-1/2	3-5/16	4-49/64	7-19/32	#2	1/16	2T-2SR	24000S-002I
	Extended	4-1/2	5-5/16	6-49/64	9-19/32	#2	1/16	2T-2SR	25000S-002I
i 0.5	Short	1-3/8	2-3/16	3-41/64	6-15/32	#2	1/16	2T-2SR	22005S-002I
	Standard	2-1/2	3-5/16	4-49/64	7-19/32	#2	1/16	2T-2SR	24005S-002I
	Extended	4-1/2	5-5/16	6-49/64	9-19/32	#2	1/16	2T-2SR	25005S-002I
m 0	Short	35.0	55.5	92.4	164.3	#2**	1/16*	2T-2SRM	22000S-002M
	Short	35.0	55.5	92.4	164.3	#2**	1/16*	2T-2SRM	22005S-002M

\*Metric thread to BSP and ISO 7-1

\*\*Per ISO 296 type BEK

**NOTE:** 0.5 series inserts fit into both 0 and 0.5 series holders. However, 0 series inserts ONLY fit into 0 series holders. See page A30: 7 for visual.

### Connection Accessories

Series	Insert Screws	Nylon Locking Screws	Insert Driver	Preset Torque Hand Driver	Replacement Tips	Admissible Tightening Torque*
0	72556-IP8-1	72556N-IP8-1	8IP-8	8IP-8TL	8IP-8B	15.5 in-lbs (175 N-cm)
0.5	72567-IP8-1	72567N-IP8-1	8IP-8	8IP-8TL	8IP-8B	15.5 in-lbs (175 N-cm)

\*Tightening torques are calculated with a friction coefficient of  $\mu = 0.14$  and develop 90% of ultimate yield strength

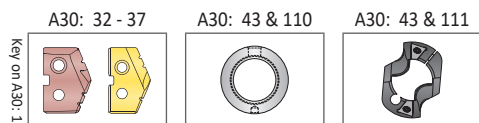

Key on A30: 1

i = Imperial (in)

m = Metric (mm)

Screws sold in quantities of 10

**WARNING** Refer to Speed and Feed charts for recommended adjustments to speeds and feeds. Refer to page A30: 146 for deep hole drilling guidelines in this section of the catalog. Visit [www.alliedmachine.com/DeepHoleGuidelines](http://www.alliedmachine.com/DeepHoleGuidelines) for the most up-to-date information and procedures. Factory technical assistance is available for your specific applications through our Application Engineering Team.





## T-A Drill Insert Holders

0 Series | Taper Shank | Diameter Range: 0.511" - 0.695" (12.98 mm - 17.65 mm)

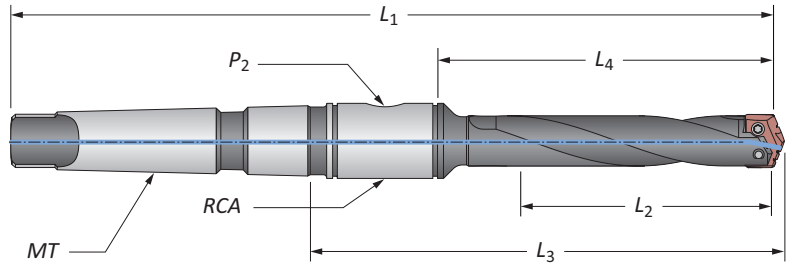

### Helical Flute

Series	Length	Body				Shank			Part No.	
		L <sub>2</sub>	L <sub>4</sub>	L <sub>3</sub>	L <sub>1</sub>	MT	P <sub>2</sub>	RCA		
i	0	Standard	2-1/2	3-5/16	4-49/64	7-19/32	#2	1/16	2T-2SR	24000H-002I
	0.5	Extended	4-1/2	5-5/16	6-49/64	9-19/32	#2	1/16	2T-2SR	25000H-002I
		Long	7	7-13/16	8-17/64	12-3/32	#2	1/16	2T-2SR	26000H-002I
m	0	Standard	63.5	84.1	121.0	192.9	#2**	1/16*	2T-2SRM	24000H-002M
		Extended	114.3	135.0	171.8	243.7	#2**	1/16*	2T-2SRM	25000H-002M
		Long	177.8	198.5	235.3	307.2	#2**	1/16*	2T-2SRM	26000H-002M
	0.5	Standard	63.5	84.1	121.0	192.9	#2**	1/16*	2T-2SRM	24005H-002M
		Extended	114.3	135.0	171.8	243.7	#2**	1/16*	2T-2SRM	25005H-002M
		Long	177.8	198.5	235.3	307.2	#2**	1/16*	2T-2SRM	26005H-002M

\*Metric thread to BSP and ISO 7-1

\*\*Per ISO 296 type BEK

**NOTE:** 0.5 series inserts fit into both 0 and 0.5 series holders. However, 0 series inserts ONLY fit into 0 series holders. See page A30: 7 for visual.

### Connection Accessories

Series	Insert Screws	Nylon Locking Screws	Insert Driver	Preset Torque Hand Driver	Replacement Tips	Admissible Tightening Torque*
0	72556-IP8-1	72556N-IP8-1	8IP-8	8IP-8TL	8IP-8B	15.5 in-lbs (175 N-cm)
0.5	72567-IP8-1	72567N-IP8-1	8IP-8	8IP-8TL	8IP-8B	15.5 in-lbs (175 N-cm)

\*Tightening torques are calculated with a friction coefficient of  $\mu = 0.14$  and develop 90% of ultimate yield strength

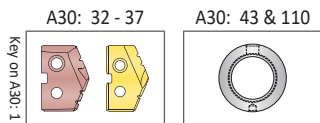

i = Imperial (in)  
m = Metric (mm)

Screws sold in quantities of 10

**WARNING** Refer to Speed and Feed charts for recommended adjustments to speeds and feeds. Refer to page A30: 146 for deep hole drilling guidelines in this section of the catalog. Visit [www.alliedmachine.com/DeepHoleGuidelines](http://www.alliedmachine.com/DeepHoleGuidelines) for the most up-to-date information and procedures. Factory technical assistance is available for your specific applications through our Application Engineering Team.

## T-A® Drill Insert Holders

0 Series | Straight Shank | ER Collet | Diameter Range: 0.511" - 0.695" (12.98 mm - 17.65 mm)

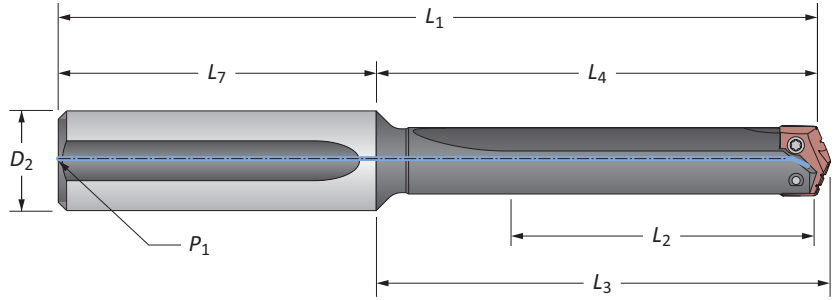

### Straight Flute

Series	Length	Body				Shank			Part No.
		L <sub>2</sub>	L <sub>4</sub>	L <sub>3</sub>	L <sub>1</sub>	D <sub>2</sub>	L <sub>7</sub>	P <sub>1</sub>	
0	Short	1-3/8	2-3/16	2-19/64	4-9/16	3/4	2-3/8	1/8	22000S-075L
	Standard	2-1/2	3-5/16	3-27/64	5-11/16	3/4	2-3/8	1/8	24000S-075L
	Extended	4-1/2	5-5/16	5-27/64	7-11/16	3/4	2-3/8	1/8	25000S-075L
	Long	7	7-13/16	7-59/64	10-3/16	3/4	2-3/8	1/8	26000S-075L
	XL	11-5/8	12-7/16	12-35/64	14-13/16	3/4	2-3/8	1/8	27000S-075L
0.5	3XL	15-1/4	16-1/16	16-11/64	18-7/16	3/4	2-3/8	1/8	29000S-075L
	Short	1-3/8	2-3/16	2-19/64	4-9/16	3/4	2-3/8	1/8*	22005S-075L
	Standard	2-1/2	3-5/16	3-27/64	5-11/16	3/4	2-3/8	1/8*	24005S-075L
	Extended	4-1/2	5-5/16	5-27/64	7-11/16	3/4	2-3/8	1/8*	25005S-075L
	Long	7	7-13/16	7-59/64	10-3/16	3/4	2-3/8	1/8*	26005S-075L

**NOTE:** 0.5 series inserts fit into both 0 and 0.5 series holders. However, 0 series inserts ONLY fit into 0 series holders. See page A30: 7 for visual.

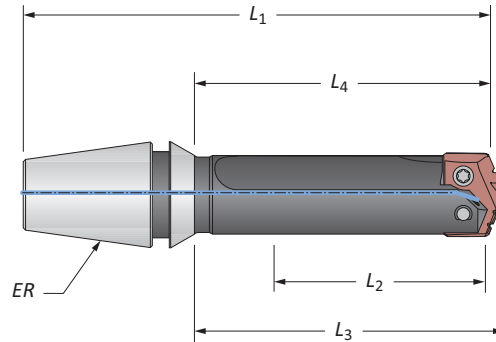

### ER Collet Holder

Series	Body				ER	Part No.	Collet Nut without Retaining Ring
	L <sub>2</sub>	L <sub>4</sub>	L <sub>3</sub>	L <sub>1</sub>			
0	1-3/8	1-57/64	2	3-5/64	ER-16	21000S-16ER	ER-16N
	1-3/8	1-57/64	2	3-15/64	ER-20	21000S-20ER	ER-20N

### Connection Accessories

Series	Insert Screws	Nylon Locking Screws	Insert Driver	Preset Torque Hand Driver	Replacement Tips	Admissible Tightening Torque*
0	72556-IP8-1	72556N-IP8-1	8IP-8	8IP-8TL	8IP-8B	15.5 in-lbs (175 N-cm)
0.5	72567-IP8-1	72567N-IP8-1	8IP-8	8IP-8TL	8IP-8B	15.5 in-lbs (175 N-cm)

\*Tightening torques are calculated with a friction coefficient of  $\mu = 0.14$  and develop 90% of ultimate yield strength

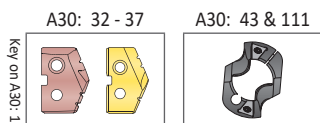

i = Imperial (in)  
m = Metric (mm)

Screws sold in quantities of 10

**WARNING** Refer to Speed and Feed charts for recommended adjustments to speeds and feeds. Refer to page A30: 146 for deep hole drilling guidelines in this section of the catalog. Visit [www.alliedmachine.com/DeepHoleGuidelines](http://www.alliedmachine.com/DeepHoleGuidelines) for the most up-to-date information and procedures. Factory technical assistance is available for your specific applications through our Application Engineering Team.



## T-A® Drill Accessories

O Series | Chamfer Rings | Rotary Coolant Adapters | Torx® Plus Screws

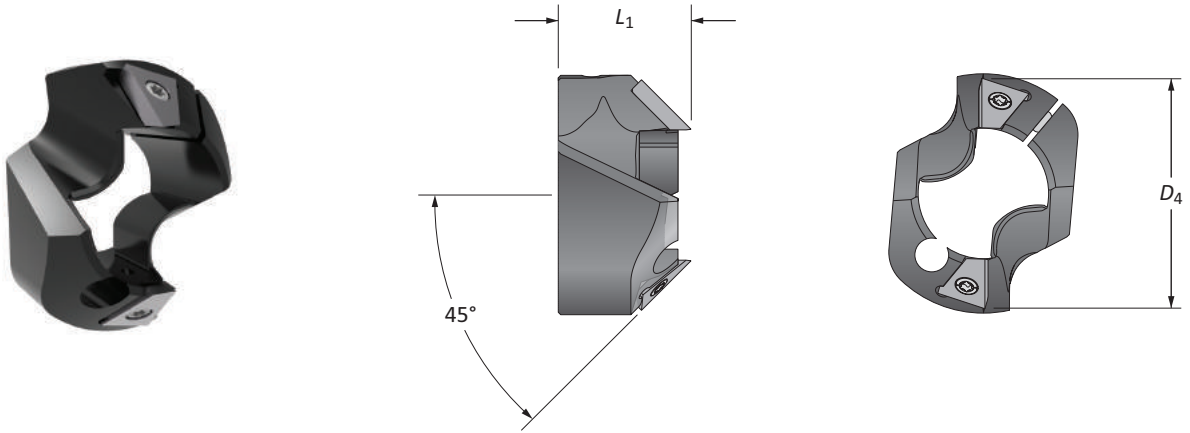

T-ACR 45 Chamfer Ring

Holder Series	D <sub>1</sub> Range	Chamfer Ring		Part No.	Insert Part No.	Insert Screw	Insert Driver	Clamping Screw	Insert Driver
		D <sub>4</sub>	L <sub>1</sub>						
0	0.5118 - 0.6890	13/16	0.676	<b>T-ACR-45-0</b>	T-ACRI-45-B-C5A	7255-IP8-1	8IP-8	7375-IP9-1	8IP-9

### Rotary Coolant Adapter (RCA) and Accessories

ID	OD	L <sub>1</sub>	Driving Rod Thread	P <sub>1</sub>	Part No.	RCA O-Rings	
						Kit Part No.**	Replacements
<b>i</b> 3/4	1-3/4	7/8	5/16-18	1/8	<b>⚠ 2T-2SR</b>	2T1-2SR	2T1-2OR-10
<b>m</b> 19.05	44.45	22.23	M8 x 1.25	1/8*	<b>⚠ 2T-2SRM</b>	2T1-2SR	2T1-2OR-10

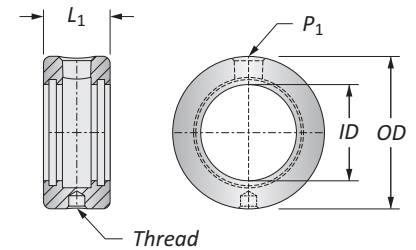

\*Thread to BSP and ISO 7-1

\*\*RCA Repair Kit includes (2) O-rings, (2) snap rings, and (2) thrust washers

**⚠** Refer to page A30: 110 for proper RCA assembly and safety information

### Connection Accessories

Series	Insert Screws	Nylon Locking Screws	Insert Driver	Preset Torque Hand Driver	Replacement Tips	Admissible Tightening Torque*
0	72556-IP8-1	72556N-IP8-1	8IP-8	8IP-8TL	8IP-8B	15.5 in-lbs (175 N-cm)
0.5	72567-IP8-1	72567N-IP8-1	8IP-8	8IP-8TL	8IP-8B	15.5 in-lbs (175 N-cm)

\*Tightening torques are calculated with a friction coefficient of  $\mu = 0.14$  and develop 90% of ultimate yield strength

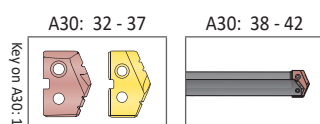

**i** = Imperial (in)  
**m** = Metric (mm)  
 Chamfer Ring Inserts sold separately  
 Screws sold in packs of 10  
 O-rings sold in packs of 10



**⚠ WARNING** RCA rotation during drilling can cause hose and/or hose fitting failure, machinery damage, and/or serious injury. To prevent, use RCA and positive stop studs when drilling. Factory technical assistance is also available for your specific applications.

## GEN2 T-A® Drill Inserts

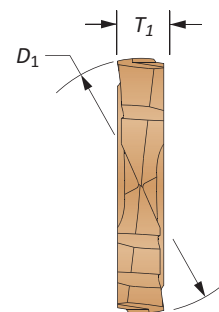
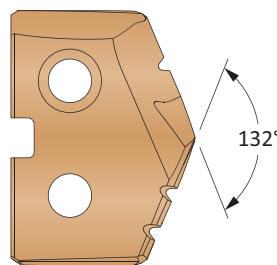
1 Series | Diameter Range: 0.690" - 0.960" (17.53 mm - 24.38 mm)



HSS Inserts – Super Cobalt • Carbide Inserts – C2 (K20) | C1 (K35)

Series	Fractional Equivalent	Insert			HSS Part No.	Carbide Part No.	
		$D_1$ inch	$D_1$ mm	$T_1$	 AM200® Super Cobalt	 AM300® C2 (K20)	 AM300® C1 (K35)
1	45/64	0.7031	17.86	5/32	451H-.703	4C21P-.703	4C11P-.703
	-	0.7087	18.00	5/32	451H-18	4C21P-18	4C11P-18
	23/32	0.7188	18.26	5/32	451H-0023	4C21P-0023	4C11P-0023
	-	0.7283	18.50	5/32	451H-18.5	4C21P-18.5	4C11P-18.5
	47/64	0.7344	18.65	5/32	451H-.734	4C21P-.734	4C11P-.734
	-	0.7480	19.00	5/32	451H-19	4C21P-19	4C11P-19
	3/4	0.7500	19.05	5/32	451H-0024	4C21P-0024	4C11P-0024
	49/64	0.7656	19.45	5/32	451H-.765	4C21P-.765	4C11P-.765
	-	0.7677	19.50	5/32	451H-19.5	4C21P-19.5	4C11P-19.5
	25/32	0.7813	19.84	5/32	451H-0025	4C21P-0025	4C11P-0025
	-	0.7874	20.00	5/32	451H-20	4C21P-20	4C11P-20
	51/64	0.7969	20.24	5/32	451H-.796	4C21P-.796	4C11P-.796
	-	0.8010	20.34	5/32	451H-.801	4C21P-.801	4C11P-.801
	-	0.8071	20.50	5/32	451H-20.5	4C21P-20.5	4C11P-20.5
	13/16	0.8125	20.64	5/32	451H-0026	4C21P-0026	4C11P-0026
	-	0.8268	21.00	5/32	451H-21	4C21P-21	4C11P-21
27/32	0.8438	21.43	5/32	451H-0027	4C21P-0027	4C11P-0027	
-	0.8465	21.50	5/32	451H-21.5	4C21P-21.5	4C11P-21.5	
1.5	55/64	0.8594	21.83	5/32	451H-.859	4C21P-.859	4C11P-.859
	-	0.8661	22.00	5/32	451H-22	4C21P-22	4C11P-22
	7/8	0.8750	22.23	5/32	451H-0028	4C21P-0028	4C11P-0028
	-	0.8858	22.50	5/32	451H-22.5	4C21P-22.5	4C11P-22.5
	57/64	0.8906	22.62	5/32	451H-.890	4C21P-.890	4C11P-.890
	-	0.9055	23.00	5/32	451H-23	4C21P-23	4C11P-23
	29/32	0.9063	23.02	5/32	451H-0029	4C21P-0029	4C11P-0029
	59/64	0.9219	23.42	5/32	451H-.921	4C21P-.921	4C11P-.921
	-	0.9252	23.50	5/32	451H-23.5	4C21P-23.5	4C11P-23.5
	15/16	0.9375	23.81	5/32	451H-0030	4C21P-0030	4C11P-0030
-	0.9449	24.00	5/32	451H-24	4C21P-24	4C11P-24	

**NOTE:** 1.5 series inserts fit into both 1 and 1.5 series holders. However, 1 series inserts ONLY fit into 1 series holders. See page A30: 7 for visual.

Inserts sold in quantities of 2

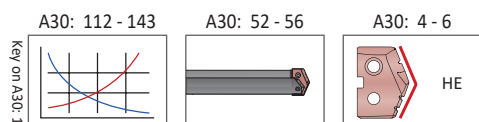

Coatings not listed above can be supplied as non-stocked standards. Process fees apply. →

TiN = 451T-XXXX	TiAlN = 451A-XXXX
TiCN = 451N-XXXX	AM200® = 451H-XXXX



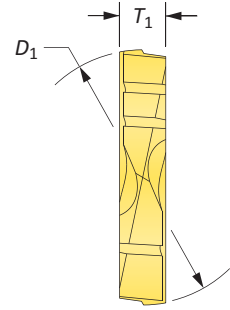
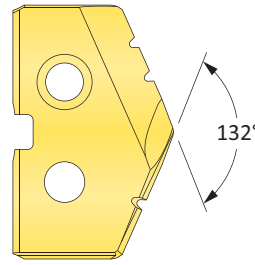

T-A® Drill Inserts

1 Series | HSS | Diameter Range: 0.690" - 0.960" (17.53 mm - 24.38 mm)



HSS Inserts – Premium Cobalt

Series	Insert				Part No.		
	Fractional Equivalent	D <sub>1</sub> inch	D <sub>1</sub> mm	T <sub>1</sub>	 TiN	 TiAlN	 TiCN
1	45/64	0.7031	17.86	5/32	181T-.703	181A-.703	181N-.703
	-	0.7087	18.00	5/32	181T-18	181A-18	181N-18
	23/32	0.7188	18.26	5/32	181T-0023	181A-0023	181N-0023
	-	0.7283	18.50	5/32	181T-18.5	181A-18.5	181N-18.5
	47/64	0.7344	18.65	5/32	181T-.734	181A-.734	181N-.734
	-	0.7480	19.00	5/32	181T-19	181A-19	181N-19
	3/4	0.7500	19.05	5/32	181T-0024	181A-0024	181N-0024
	49/64	0.7656	19.45	5/32	181T-.765	181A-.765	181N-.765
	-	0.7677	19.50	5/32	181T-19.5	181A-19.5	181N-19.5
	25/32	0.7813	19.84	5/32	181T-0025	181A-0025	181N-0025
	-	0.7874	20.00	5/32	181T-20	181A-20	181N-20
	51/64	0.7969	20.24	5/32	181T-.796	181A-.796	181N-.796
	-	0.8010	20.34	5/32	181T-.801	181A-.801	181N-.801
	-	0.8071	20.50	5/32	181T-20.5	181A-20.5	181N-20.5
	13/16	0.8125	20.64	5/32	181T-0026	181A-0026	181N-0026
-	0.8268	21.00	5/32	181T-21	181A-21	181N-21	
27/32	0.8438	21.43	5/32	181T-0027	181A-0027	181N-0027	
-	0.8465	21.50	5/32	181T-21.5	181A-21.5	181N-21.5	
1.5	55/64	0.8594	21.83	5/32	181T-.859	181A-.859	181N-.859
	-	0.8661	22.00	5/32	181T-22	181A-22	181N-22
	7/8	0.8750	22.23	5/32	181T-0028	181A-0028	181N-0028
	-	0.8858	22.50	5/32	181T-22.5	181A-22.5	181N-22.5
	57/64	0.8906	22.62	5/32	181T-.890	181A-.890	181N-.890
	-	0.9055	23.00	5/32	181T-23	181A-23	181N-23
	29/32	0.9063	23.02	5/32	181T-0029	181A-0029	181N-0029
	59/64	0.9219	23.42	5/32	181T-.921	181A-.921	181N-.921
	-	0.9252	23.50	5/32	181T-23.5	181A-23.5	181N-23.5
	15/16	0.9375	23.81	5/32	181T-0030	181A-0030	181N-0030
-	0.9449	24.00	5/32	181T-24	181A-24	181N-24	

NOTE: 1.5 series inserts fit into both 1 and 1.5 series holders. However, 1 series inserts ONLY fit into 1 series holders. See page A30: 7 for visual.

A30: 112 - 143

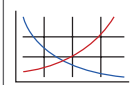

A30: 52 - 56



A30: 4 - 6

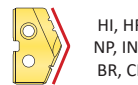

HI, HR, CR, TC, SK, NP, IN, RN, CN, AN, BR, CI, CP, NC, WC

Coatings not listed above can be supplied as non-stocked standards. Process fees apply. →

TiN = 181T-XXXX	TiAlN = 181A-XXXX
TiCN = 181N-XXXX	AM200® = 181H-XXXX



Inserts sold in quantities of 2

## T-A® Drill Inserts

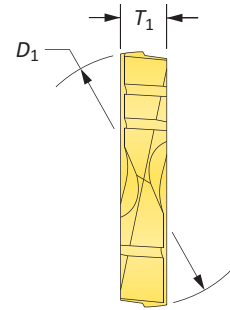
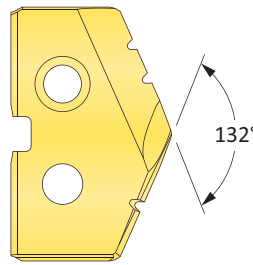
1 Series | HSS | Diameter Range: 0.690" - 0.960" (17.53 mm - 24.38 mm)



### HSS Inserts – Super Cobalt

Series	Insert				Part No.		
	Fractional Equivalent	$D_1$ inch	$D_1$ mm	$T_1$	 TiN	 TiAlN	 TiCN
1	45/64	0.7031	17.86	5/32	151T-.703	151A-.703	151N-.703
	-	0.7087	18.00	5/32	151T-18	151A-18	151N-18
	23/32	0.7188	18.26	5/32	151T-0023	151A-0023	151N-0023
	-	0.7283	18.50	5/32	151T-18.5	151A-18.5	151N-18.5
	47/64	0.7344	18.65	5/32	151T-.734	151A-.734	151N-.734
	-	0.7480	19.00	5/32	151T-19	151A-19	151N-19
	3/4	0.7500	19.05	5/32	151T-0024	151A-0024	151N-0024
	49/64	0.7656	19.45	5/32	151T-.765	151A-.765	151N-.765
	-	0.7677	19.50	5/32	151T-19.5	151A-19.5	151N-19.5
	25/32	0.7813	19.84	5/32	151T-0025	151A-0025	151N-0025
	-	0.7874	20.00	5/32	151T-20	151A-20	151N-20
	51/64	0.7969	20.24	5/32	151T-.796	151A-.796	151N-.796
	-	0.8010	20.34	5/32	151T-.801	151A-.801	151N-.801
	-	0.8071	20.50	5/32	151T-20.5	151A-20.5	151N-20.5
	13/16	0.8125	20.64	5/32	151T-0026	151A-0026	151N-0026
	-	0.8268	21.00	5/32	151T-21	151A-21	151N-21
27/32	0.8438	21.43	5/32	151T-0027	151A-0027	151N-0027	
-	0.8465	21.50	5/32	151T-21.5	151A-21.5	151N-21.5	
1.5	55/64	0.8594	21.83	5/32	151T-.859	151A-.859	151N-.859
	-	0.8661	22.00	5/32	151T-22	151A-22	151N-22
	7/8	0.8750	22.23	5/32	151T-0028	151A-0028	151N-0028
	-	0.8858	22.50	5/32	151T-22.5	151A-22.5	151N-22.5
	57/64	0.8906	22.62	5/32	151T-.890	151A-.890	151N-.890
	-	0.9055	23.00	5/32	151T-23	151A-23	151N-23
	29/32	0.9063	23.02	5/32	151T-0029	151A-0029	151N-0029
	59/64	0.9219	23.42	5/32	151T-.921	151A-.921	151N-.921
	-	0.9252	23.50	5/32	151T-23.5	151A-23.5	151N-23.5
15/16	0.9375	23.81	5/32	151T-0030	151A-0030	151N-0030	
-	0.9449	24.00	5/32	151T-24	151A-24	151N-24	

**NOTE:** 1.5 series inserts fit into both 1 and 1.5 series holders. However, 1 series inserts ONLY fit into 1 series holders. See page A30: 7 for visual.

Inserts sold in quantities of 2

A30: 112 - 143

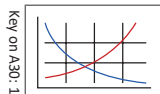

A30: 52 - 56

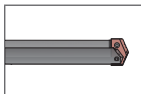

A30: 4 - 6

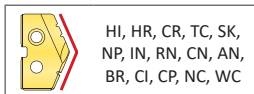

HI, HR, CR, TC, SK,  
NP, IN, RN, CN, AN,  
BR, CI, CP, NC, WC

Coatings not listed above  
can be supplied as  
non-stocked standards.  
Process fees apply. →

TiN = 151T-XXXX

TiAlN = 151A-XXXX

TiCN = 151N-XXXX

AM200® = 151H-XXXX

T-A® Drill Inserts

1 Series | HSS | Diameter Range: 0.690" - 0.960" (17.53 mm - 24.38 mm)

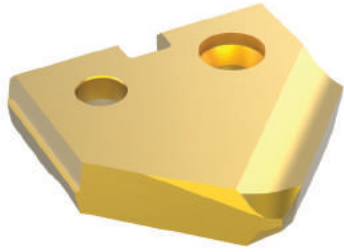



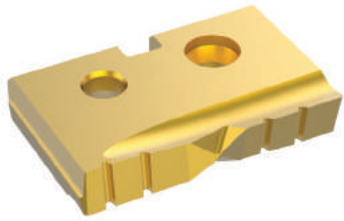
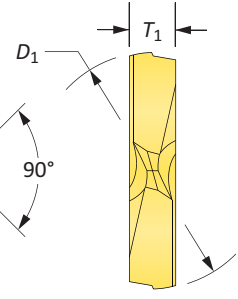
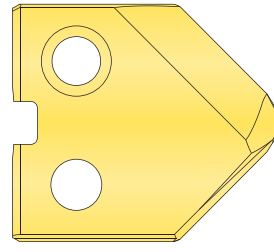

90° Spot & Chamfer

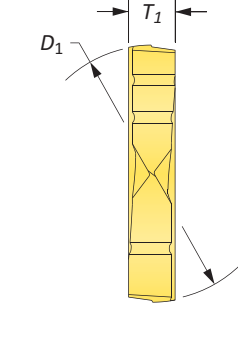
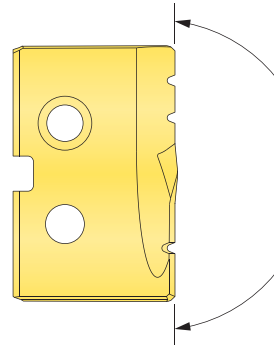





Flat Bottom

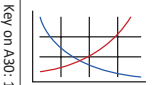

HSS Inserts – Super Cobalt

Series	Insert				90° Spot & Chamfer Part No.			Flat Bottom Part No.
	Fractional Equivalent	D <sub>1</sub> inch	D <sub>1</sub> mm	T <sub>1</sub>	 TiN	 TiAlN	 TiCN	 TiN
1	45/64	0.7031	17.86	5/32	151T-.703-SP	151A-.703-SP	151N-.703-SP	151T-.703-FB
	-	0.7087	18.00	5/32	151T-18-SP	151A-18-SP	151N-18-SP	151T-18-FB
	23/32	0.7188	18.26	5/32	151T-0023-SP	151A-0023-SP	151N-0023-SP	151T-0023-FB
	-	0.7283	18.50	5/32	151T-18.5-SP	151A-18.5-SP	151N-18.5-SP	151T-18.5-FB
	47/64	0.7344	18.65	5/32	151T-.734-SP	151A-.734-SP	151N-.734-SP	151T-.734-FB
	-	0.7480	19.00	5/32	151T-19-SP	151A-19-SP	151N-19-SP	151T-19-FB
	3/4	0.7500	19.05	5/32	151T-0024-SP	151A-0024-SP	151N-0024-SP	151T-0024-FB
	49/64	0.7656	19.45	5/32	151T-.765-SP	151A-.765-SP	151N-.765-SP	151T-.765-FB
	-	0.7677	19.50	5/32	151T-19.5-SP	151A-19.5-SP	151N-19.5-SP	151T-19.5-FB
	25/32	0.7813	19.84	5/32	151T-0025-SP	151A-0025-SP	151N-0025-SP	151T-0025-FB
	-	0.7874	20.00	5/32	151T-20-SP	151A-20-SP	151N-20-SP	151T-20-FB
	51/64	0.7969	20.24	5/32	151T-.796-SP	151A-.796-SP	151N-.796-SP	151T-.796-FB
	-	0.8010	20.34	5/32	151T-.801-SP	151A-.801-SP	151N-.801-SP	151T-.801-FB
	-	0.8071	20.50	5/32	151T-20.5-SP	151A-20.5-SP	151N-20.5-SP	151T-20.5-FB
	13/16	0.8125	20.64	5/32	151T-0026-SP	151A-0026-SP	151N-0026-SP	151T-0026-FB
	-	0.8268	21.00	5/32	151T-21-SP	151A-21-SP	151N-21-SP	151T-21-FB
27/32	0.8438	21.43	5/32	151T-0027-SP	151A-0027-SP	151N-0027-SP	151T-0027-FB	
-	0.8465	21.50	5/32	151T-21.5-SP	151A-21.5-SP	151N-21.5-SP	151T-21.5-FB	
1.5	55/64	0.8594	21.83	5/32	151T-.859-SP	151A-.859-SP	151N-.859-SP	151T-.859-FB
	-	0.8661	22.00	5/32	151T-22-SP	151A-22-SP	151N-22-SP	151T-22-FB
	7/8	0.8750	22.23	5/32	151T-0028-SP	151A-0028-SP	151N-0028-SP	151T-0028-FB
	-	0.8858	22.50	5/32	151T-22.5-SP	151A-22.5-SP	151N-22.5-SP	151T-22.5-FB
	57/64	0.8906	22.62	5/32	151T-.890-SP	151A-.890-SP	151N-.890-SP	151T-.890-FB
	-	0.9055	23.00	5/32	151T-23-SP	151A-23-SP	151N-23-SP	151T-23-FB
	29/32	0.9063	23.02	5/32	151T-0029-SP	151A-0029-SP	151N-0029-SP	151T-0029-FB
	59/64	0.9219	23.42	5/32	151T-.921-SP	151A-.921-SP	151N-.921-SP	151T-.921-FB
	-	0.9252	23.50	5/32	151T-23.5-SP	151A-23.5-SP	151N-23.5-SP	151T-23.5-FB
	15/16	0.9375	23.81	5/32	151T-0030-SP	151A-0030-SP	151N-0030-SP	151T-0030-FB
-	0.9449	24.00	5/32	151T-24-SP	151A-24-SP	151N-24-SP	151T-24-FB	

NOTE: 1.5 series inserts fit into both 1 and 1.5 series holders. However, 1 series inserts ONLY fit into 1 series holders. See page A30: 7 for visual.

A30: 112 - 143  A30: 52 - 56  A30: 4 - 6  SW A30: 4 - 6  FN

Coatings not listed above can be supplied as non-stocked standards. Process fees apply. →

Inserts sold in quantities of 2

TiN = 151T-XXXX	TiAlN = 151A-XXXX
TiCN = 151N-XXXX	AM200® = 151H-XXXX

## T-A® Drill Inserts

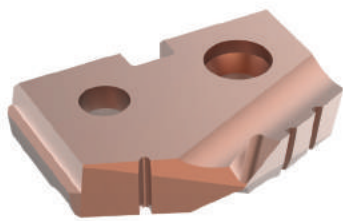

1 Series | HSS | Diameter Range: 0.690" - 0.960" (17.53 mm - 24.38 mm)

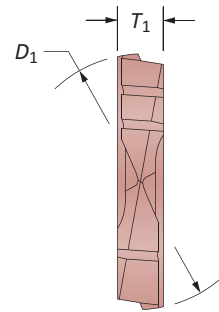
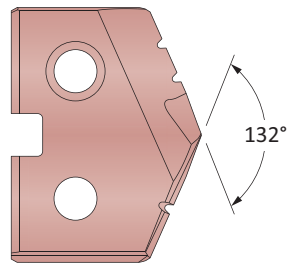

Tube Sheet



HSS Inserts – Super Cobalt | HSS

Series	Fractional Equivalent	Insert			Part No.	
		$D_1$ inch	$D_1$ mm	$T_1$	 Super Cobalt	 HSS
1	–	0.7580	19.25	5/32	<b>151H-.7580-IN</b>	<b>131H-.7580-IN</b>
	49/64	0.7656	19.45	5/32	<b>151H-.765-IN</b>	<b>131H-.765-IN</b>
	25/32	0.7813	19.85	5/32	<b>151H-0025-IN</b>	<b>131H-0025-IN</b>

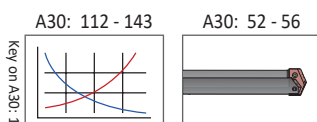

Coatings not listed above can be supplied as non-stocked standards. Process fees apply. →

TiN = 151T-XXXX	TiAlN = 151A-XXXX
TiCN = 151N-XXXX	AM200® = 151H-XXXX

Inserts sold in quantities of 2



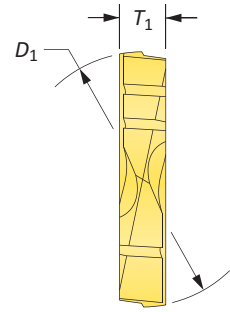
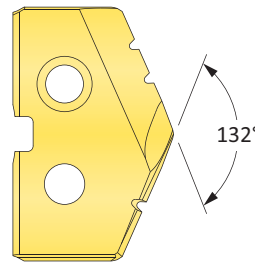

**T-A® Drill Inserts**

1 Series | HSS | Diameter Range: 0.690" - 0.960" (17.53 mm - 24.38 mm)





**HSS Inserts – HSS**

Series	Fractional Equivalent	Insert			Part No.		
		D <sub>1</sub> inch	D <sub>1</sub> mm	T <sub>1</sub>	 TiN	 TiAlN	 TiCN
1	45/64	0.7031	17.86	5/32	131T-703	131A-703	131N-703
	-	0.7087	18.00	5/32	131T-18	131A-18	131N-18
	23/32	0.7188	18.26	5/32	131T-0023	131A-0023	131N-0023
	-	0.7283	18.50	5/32	131T-18.5	131A-18.5	131N-18.5
	47/64	0.7344	18.65	5/32	131T-.734	131A-.734	131N-.734
	-	0.7480	19.00	5/32	131T-19	131A-19	131N-19
	3/4	0.7500	19.05	5/32	131T-0024	131A-0024	131N-0024
	49/64	0.7656	19.45	5/32	131T-.765	131A-.765	131N-.765
	-	0.7677	19.50	5/32	131T-19.5	131A-19.5	131N-19.5
	25/32	0.7813	19.84	5/32	131T-0025	131A-0025	131N-0025
	-	0.7874	20.00	5/32	131T-20	131A-20	131N-20
	51/64	0.7969	20.24	5/32	131T-.796	131A-.796	131N-.796
	-	0.8010	20.34	5/32	131T-.801	131A-.801	131N-.801
	-	0.8071	20.50	5/32	131T-20.5	131A-20.5	131N-20.5
	13/16	0.8125	20.64	5/32	131T-0026	131A-0026	131N-0026
-	0.8268	21.00	5/32	131T-21	131A-21	131N-21	
27/32	0.8438	21.43	5/32	131T-0027	131A-0027	131N-0027	
-	0.8465	21.50	5/32	131T-21.5	131A-21.5	131N-21.5	
1.5	55/64	0.8594	21.83	5/32	131T-.859	131A-.859	131N-.859
	-	0.8661	22.00	5/32	131T-22	131A-22	131N-22
	7/8	0.8750	22.23	5/32	131T-0028	131A-0028	131N-0028
	-	0.8858	22.50	5/32	131T-22.5	131A-22.5	131N-22.5
	57/64	0.8906	22.62	5/32	131T-.890	131A-.890	131N-.890
	-	0.9055	23.00	5/32	131T-23	131A-23	131N-23
	29/32	0.9063	23.02	5/32	131T-0029	131A-0029	131N-0029
	59/64	0.9219	23.42	5/32	131T-.921	131A-.921	131N-.921
	-	0.9252	23.50	5/32	131T-23.5	131A-23.5	131N-23.5
	15/16	0.9375	23.81	5/32	131T-0030	131A-0030	131N-0030
-	0.9449	24.00	5/32	131T-24	131A-24	131N-24	

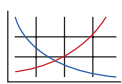
**NOTE:** 1.5 series inserts fit into both 1 and 1.5 series holders. However, 1 series inserts ONLY fit into 1 series holders. See page A30: 7 for visual.

A30: 112 - 143 

A30: 52 - 56 

A30: 4 - 6  HI, HR, CR, TC, SK, NP, IN, RN, CN, AN, BR, CI, CP, NC, WC

Coatings not listed above can be supplied as non-stocked standards. Process fees apply. →

TiN = 131T-XXXX	TiAlN = 131A-XXXX
TiCN = 131N-XXXX	AM200® = 131H-XXXX

Inserts sold in quantities of 2

## T-A® Drill Inserts

1 Series | Carbide | Diameter Range: 0.690" - 0.960" (17.53 mm - 24.38 mm)



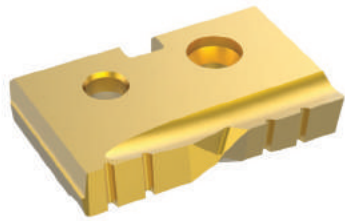
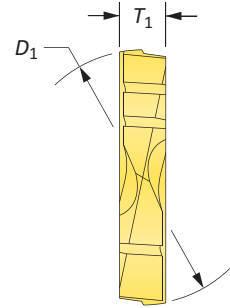
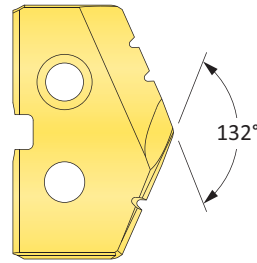

Standard

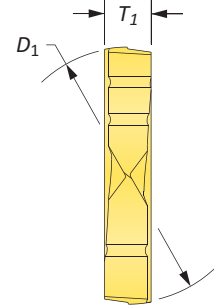
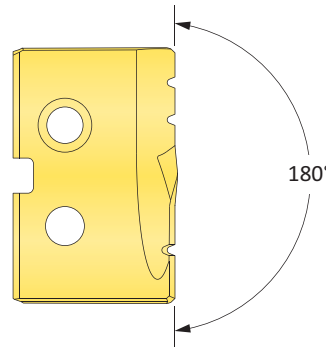

Flat Bottom



### Carbide Inserts – C2 (K20)

Series	Insert				Part No.		Flat Bottom Part No.
	Fractional Equivalent	D <sub>1</sub> inch	D <sub>1</sub> mm	T <sub>1</sub>	 TiN	 TiAlN	 TiN
1	45/64	0.7031	17.86	5/32	1C21T-.703	1C21A-.703	1C21T-.703-FB
	-	0.7087	18.00	5/32	1C21T-18	1C21A-18	1C21T-18-FB
	23/32	0.7188	18.26	5/32	1C21T-0023	1C21A-0023	1C21T-0023-FB
	-	0.7283	18.50	5/32	1C21T-18.5	1C21A-18.5	1C21T-18.5-FB
	47/64	0.7344	18.65	5/32	1C21T-.734	1C21A-.734	1C21T-.734-FB
	-	0.7480	19.00	5/32	1C21T-19	1C21A-19	1C21T-19-FB
	3/4	0.7500	19.05	5/32	1C21T-0024	1C21A-0024	1C21T-0024-FB
	49/64	0.7656	19.45	5/32	1C21T-.765	1C21A-.765	1C21T-.765-FB
	-	0.7677	19.50	5/32	1C21T-19.5	1C21A-19.5	1C21T-19.5-FB
	25/32	0.7813	19.84	5/32	1C21T-0025	1C21A-0025	1C21T-0025-FB
	-	0.7874	20.00	5/32	1C21T-20	1C21A-20	1C21T-20-FB
	51/64	0.7969	20.24	5/32	1C21T-.796	1C21A-.796	1C21T-.796-FB
	-	0.8010	20.34	5/32	1C21T-.801	1C21A-.801	1C21T-.801-FB
	-	0.8071	20.50	5/32	1C21T-20.5	1C21A-20.5	1C21T-20.5-FB
	13/16	0.8125	20.64	5/32	1C21T-0026	1C21A-0026	1C21T-0026-FB
	-	0.8268	21.00	5/32	1C21T-21	1C21A-21	1C21T-21-FB
1.5	27/32	0.8438	21.43	5/32	1C21T-0027	1C21A-0027	1C21T-0027-FB
	-	0.8465	21.50	5/32	1C21T-21.5	1C21A-21.5	1C21T-21.5-FB
	55/64	0.8594	21.83	5/32	1C21T-.859	1C21A-.859	1C21T-.859-FB
	-	0.8661	22.00	5/32	1C21T-22	1C21A-22	1C21T-22-FB
	7/8	0.8750	22.23	5/32	1C21T-0028	1C21A-0028	1C21T-0028-FB
	-	0.8858	22.50	5/32	1C21T-22.5	1C21A-22.5	1C21T-22.5-FB
	57/64	0.8906	22.62	5/32	1C21T-.890	1C21A-.890	1C21T-.890-FB
	-	0.9055	23.00	5/32	1C21T-23	1C21A-23	1C21T-23-FB
	29/32	0.9063	23.02	5/32	1C21T-0029	1C21A-0029	1C21T-0029-FB
	59/64	0.9219	23.42	5/32	1C21T-.921	1C21A-.921	1C21T-.921-FB
-	0.9252	23.50	5/32	1C21T-23.5	1C21A-23.5	1C21T-23.5-FB	
15/16	0.9375	23.81	5/32	1C21T-0030	1C21A-0030	1C21T-0030-FB	
-	0.9449	24.00	5/32	1C21T-24	1C21A-24	1C21T-24-FB	

**NOTE:** 1.5 series inserts fit into both 1 and 1.5 series holders. However, 1 series inserts ONLY fit into 1 series holders. See page A30: 7 for visual.

A30: 112 - 143

A30: 52 - 56

A30: 4 - 6

A30: 4 - 6

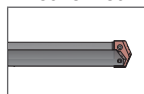
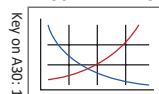

HI, HR, CR, TC, SK,  
NP, IN, RN, CN,  
AN, BR, CI, CP, NC,  
WC, BT

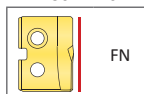

Coatings not listed above  
can be supplied as  
non-stocked standards.  
Process fees apply. →

TiN = 1C21T-XXXX	TiAlN = 1C21A-XXXX
TiCN = 1C21N-XXXX	AM200® = 1C21H-XXXX

Inserts sold in quantities of 2



T-A® Drill Inserts

1 Series | Carbide | Diameter Range: 0.690" - 0.960" (17.53 mm - 24.38 mm)

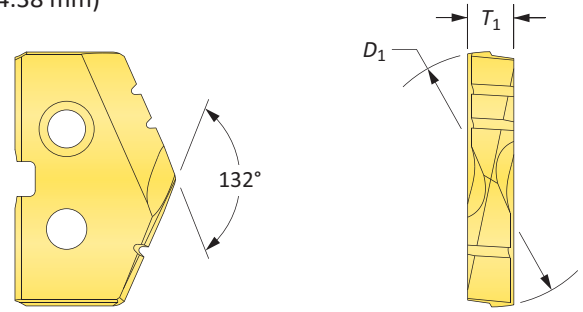

Carbide Inserts – C5 (P40) | C3 (K10) | N2

Series	Insert				C5 Part No.		C3 Part No.	N2 Part No.
	Fractional Equivalent	D <sub>1</sub> inch	D <sub>1</sub> mm	T <sub>1</sub>	TiN	TiAlN	TiAlN (Cast Iron)	Diamond Film*
1	45/64	0.7031	17.86	5/32	1C51T-.703	1C51A-.703	1C31A-.703-CI	1N21D-.703
	-	0.7087	18.00	5/32	1C51T-18	1C51A-18	1C31A-18-CI	1N21D-18
	23/32	0.7188	18.26	5/32	1C51T-0023	1C51A-0023	1C31A-0023-CI	1N21D-0023
	-	0.7283	18.50	5/32	1C51T-18.5	1C51A-18.5	1C31A-18.5-CI	1N21D-18.5
	47/64	0.7344	18.65	5/32	1C51T-.734	1C51A-.734	1C31A-.734-CI	1N21D-.734
	-	0.7480	19.00	5/32	1C51T-19	1C51A-19	1C31A-19-CI	1N21D-19
	3/4	0.7500	19.05	5/32	1C51T-0024	1C51A-0024	1C31A-0024-CI	1N21D-0024
	49/64	0.7656	19.45	5/32	1C51T-.765	1C51A-.765	1C31A-.765-CI	1N21D-.765
	-	0.7677	19.50	5/32	1C51T-19.5	1C51A-19.5	1C31A-19.5-CI	1N21D-19.5
	25/32	0.7813	19.84	5/32	1C51T-0025	1C51A-0025	1C31A-0025-CI	1N21D-0025
	-	0.7874	20.00	5/32	1C51T-20	1C51A-20	1C31A-20-CI	1N21D-20
	51/64	0.7969	20.24	5/32	1C51T-.796	1C51A-.796	1C31A-.796-CI	1N21D-.796
	-	0.8010	20.34	5/32	1C51T-.801	1C51A-.801	1C31A-.801-CI	1N21D-.801
	-	0.8071	20.50	5/32	1C51T-20.5	1C51A-20.5	1C31A-20.5-CI	1N21D-20.5
	13/16	0.8125	20.64	5/32	1C51T-0026	1C51A-0026	1C31A-0026-CI	1N21D-0026
	-	0.8268	21.00	5/32	1C51T-21	1C51A-21	1C31A-21-CI	1N21D-21
27/32	0.8438	21.43	5/32	1C51T-0027	1C51A-0027	1C31A-0027-CI	1N21D-0027	
-	0.8465	21.50	5/32	1C51T-21.5	1C51A-21.5	1C31A-21.5-CI	1N21D-21.5	
1.5	55/64	0.8594	21.83	5/32	1C51T-.859	1C51A-.859	1C31A-.859-CI	1N21D-.859
	-	0.8661	22.00	5/32	1C51T-22	1C51A-22	1C31A-22-CI	1N21D-22
	7/8	0.8750	22.23	5/32	1C51T-0028	1C51A-0028	1C31A-0028-CI	1N21D-0028
	-	0.8858	22.50	5/32	1C51T-22.5	1C51A-22.5	1C31A-22.5-CI	1N21D-22.5
	57/64	0.8906	22.62	5/32	1C51T-.890	1C51A-.890	1C31A-.890-CI	1N21D-.890
	-	0.9055	23.00	5/32	1C51T-23	1C51A-23	1C31A-23-CI	1N21D-23
	29/32	0.9063	23.02	5/32	1C51T-0029	1C51A-0029	1C31A-0029-CI	1N21D-0029
	59/64	0.9219	23.42	5/32	1C51T-.921	1C51A-.921	1C31A-.921-CI	1N21D-.921
	-	0.9252	23.50	5/32	1C51T-23.5	1C51A-23.5	1C31A-23.5-CI	1N21D-23.5
	15/16	0.9375	23.81	5/32	1C51T-0030	1C51A-0030	1C31A-0030-CI	1N21D-0030
-	0.9449	24.00	5/32	1C51T-24	1C51A-24	1C31A-24-CI	1N21D-24	

NOTE: 1.5 series inserts fit into both 1 and 1.5 series holders. However, 1 series inserts ONLY fit into 1 series holders. See page A30: 7 for visual.

\*Diamond Film is only available in standard geometry. For additional geometries, please contact Application Engineering.

A30: 112 - 143

A30: 52 - 56

A30: 4 - 6

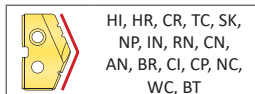
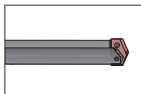
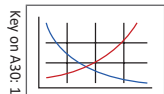

Coatings not listed above can be supplied as non-stocked standards. Process fees apply. →

Inserts sold in quantities of 2

TiN = 1C51T-XXXX	TiAlN = 1C51A-XXXX
TiCN = 1C51N-XXXX	AM200® = 1C51H-XXXX

## T-A® Drill Insert Holders

1 Series | Flange Shank | Diameter Range: 0.690" - 0.960" (17.53 mm - 24.38 mm)

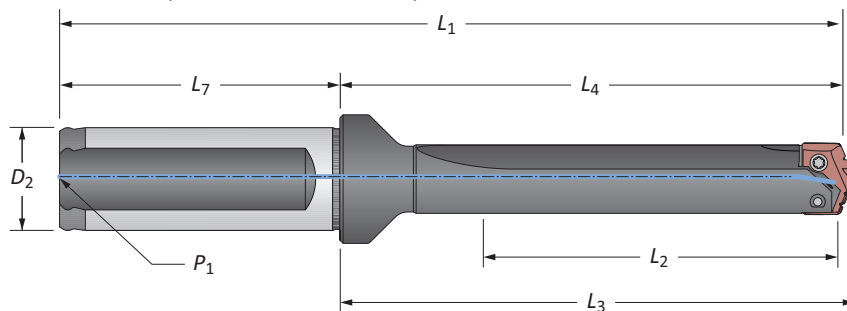

Stub Length

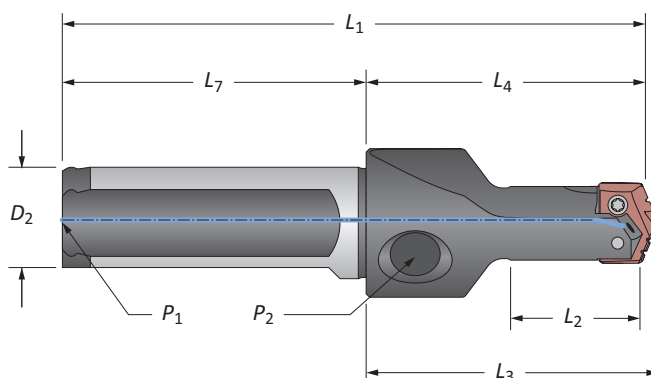

### Straight Flute

Series	Length	Body				Shank			Part No.	
		L <sub>2</sub>	L <sub>4</sub>	L <sub>3</sub>	L <sub>1</sub>	D <sub>2</sub>	L <sub>7</sub>	P <sub>1</sub>		
1	Stub	1-7/8	2-63/64	3-1/8	5-17/64	1	2-9/32	1/8	21010S-100F	
	Short	2-5/8	4-7/32	4-23/64	6-1/2	1	2-9/32	1/8	22010S-100F	
	Intermediate	4-5/8	6-3/32	6-15/64	8-3/8	1	2-9/32	1/8	23010S-100F	
	Standard	6-5/8	8-3/32	8-15/64	10-3/8	1	2-9/32	1/8	24010S-100F	
	Extended	10-5/8	12-3/32	12-15/64	14-3/8	1	2-9/32	1/8	<b>25010S-100F</b>	
1.5	Stub	2-1/4	3-31/64	3-5/8	5-49/64	1	2-9/32	1/8	21015S-100F	
	Short	2-5/8	4-7/32	4-23/64	6-1/2	1	2-9/32	1/8	22015S-100F	
	Intermediate	4-5/8	6-3/32	6-15/64	8-3/8	1	2-9/32	1/8	23015S-100F	
	Standard	6-5/8	8-3/32	8-15/64	10-3/8	1	2-9/32	1/8	24015S-100F	
	Extended	10-5/8	12-3/32	12-15/64	14-3/8	1	2-9/32	1/8	<b>25015S-100F</b>	
m	1	Stub	47.6	75.8	79.4	131.8	25.0	56.0	1/8*	21010S-25FM
		Short	66.7	107.2	110.7	163.2	25.0	56.0	1/8*	22010S-25FM
		XL	457.0	494.5	498.1	550.5	25.0	56.0	1/8*	<b>27010S-25FM</b>
		3XL	569.0	602.5	606.1	658.5	25.0	56.0	1/8*	<b>29010S-25FM</b>
	1.5	Stub	57.2	88.5	92.1	144.5	25.0	56.0	1/8*	21015S-25FM
		Short	66.7	107.2	110.7	163.2	25.0	56.0	1/8*	22015S-25FM

\*Metric thread to BSP and ISO 7-1

**NOTE:** Stub length holders have a 1/8" side pipe tap (P<sub>2</sub>)

**NOTE:** 1.5 series inserts fit into both 1 and 1.5 series holders. However, 1 series inserts ONLY fit into 1 series holders. See page A30: 7 for visual.

### Connection Accessories

Series	Insert Screws	Nylon Locking Screws	Insert Driver	Preset Torque Hand Driver	Replacement Tips	Admissible Tightening Torque*
1	7375-IP9-1	7375N-IP9-1	8IP-9	8IP-9TL	8IP-9B	27.0 in-lbs (305 N-cm)
1.5	739-IP9-1	739N-IP9-1	8IP-9	8IP-9TL	8IP-9B	27.0 in-lbs (305 N-cm)

\*Tightening torques are calculated with a friction coefficient of  $\mu = 0.14$  and develop 90% of ultimate yield strength

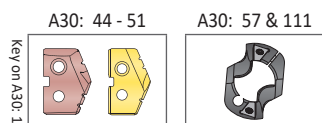

Key on A30: 1

**i** = Imperial (in)

**m** = Metric (mm)

Screws sold in quantities of 10

**WARNING** Refer to Speed and Feed charts for recommended adjustments to speeds and feeds. Refer to page A30: 146 for deep hole drilling guidelines in this section of the catalog. Visit [www.alliedmachine.com/DeepHoleGuidelines](http://www.alliedmachine.com/DeepHoleGuidelines) for the most up-to-date information and procedures. Factory technical assistance is available for your specific applications through our Application Engineering Team.

T-A® Drill Insert Holders

1 Series | Flange Shank | Diameter Range: 0.690" - 0.960" (17.53 mm - 24.38 mm)

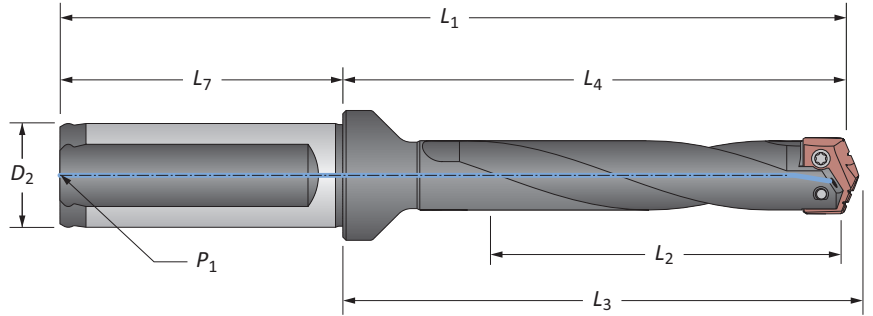

Helical Flute

Series	Length	Body				Shank			Part No.
		L <sub>2</sub>	L <sub>4</sub>	L <sub>3</sub>	L <sub>1</sub>	D <sub>2</sub>	L <sub>7</sub>	P <sub>1</sub>	
i	Intermediate	4-5/8	6-3/32	6-15/64	8-3/8	1	2-9/32	1/8	23010H-100F
	Standard	6-5/8	8-3/32	8-15/64	10-3/8	1	2-9/32	1/8	24010H-100F
	Standard Plus	8-5/8	10-3/32	10-15/64	12-33/64	1	2-9/32	1/8	24510H-100F
	Extended	10-5/8	12-3/32	12-15/64	14-3/8	1	2-9/32	1/8	25010H-100F
	Long	14-3/8	15-27/32	15-63/64	18-17/64	1	2-9/32	1/8	26010H-100F
1.5	Intermediate	4-5/8	6-3/32	6-15/64	8-3/8	1	2-9/32	1/8	23015H-100F
	Standard	6-5/8	8-3/32	8-15/64	10-3/8	1	2-9/32	1/8	24015H-100F
	Extended	10-5/8	12-3/32	12-15/64	14-3/8	1	2-9/32	1/8	25015H-100F
ii	Intermediate	117.5	154.8	158.4	210.8	25.0	56.0	1/8*	23010H-25FM
	Standard	168.3	205.6	209.2	261.6	25.0	56.0	1/8*	24010H-25FM
	Standard Plus	219.0	256.3	259.9	312.3	25.0	56.0	1/8*	24510H-25FM
	Extended	269.9	307.2	310.8	363.2	25.0	56.0	1/8*	25010H-25FM
	Long	365.0	402.3	405.9	458.3	25.0	56.0	1/8*	26010H-25FM
1.5	Intermediate	117.5	154.8	158.4	210.8	25.0	56.0	1/8*	23015H-25FM
	Standard	168.3	205.6	209.2	261.6	25.0	56.0	1/8*	24015H-25FM
	Extended	269.9	307.2	310.8	363.2	25.0	56.0	1/8*	25015H-25FM

\*Metric thread to BSP and ISO 7-1

NOTE: 1.5 series inserts fit into both 1 and 1.5 series holders. However, 1 series inserts ONLY fit into 1 series holders. See page A30: 7 for visual.

Connection Accessories

Series	Insert Screws	Nylon Locking Screws	Insert Driver	Preset Torque Hand Driver	Replacement Tips	Admissible Tightening Torque*
1	7375-IP9-1	7375N-IP9-1	8IP-9	8IP-9TL	8IP-9B	27.0 in-lbs (305 N-cm)
1.5	739-IP9-1	739N-IP9-1	8IP-9	8IP-9TL	8IP-9B	27.0 in-lbs (305 N-cm)

\*Tightening torques are calculated with a friction coefficient of  $\mu = 0.14$  and develop 90% of ultimate yield strength

A30: 44 - 51

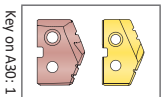

i = Imperial (in)  
m = Metric (mm)

Screws sold in quantities of 10

**WARNING** Refer to Speed and Feed charts for recommended adjustments to speeds and feeds. Refer to page A30: 146 for deep hole drilling guidelines in this section of the catalog. Visit [www.alliedmachine.com/DeepHoleGuidelines](http://www.alliedmachine.com/DeepHoleGuidelines) for the most up-to-date information and procedures. Factory technical assistance is available for your specific applications through our Application Engineering Team.

## T-A® Drill Insert Holders

1 Series | Taper Shank | Diameter Range: 0.690" - 0.960" (17.53 mm - 24.38 mm)

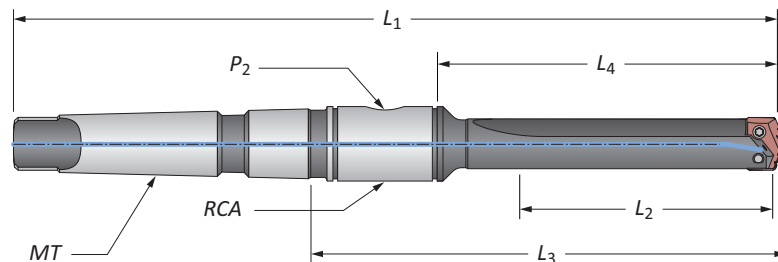

### Straight Flute

Series	Length	Body				Shank			Part No.	
		L <sub>2</sub>	L <sub>4</sub>	L <sub>3</sub>	L <sub>1</sub>	MT	P <sub>2</sub>	RCA		
1	Short	2-3/4	3-7/8	5-39/64	9-5/32	#3	1/8	2T-3SR	22010S-003I	
	Short	2-3/4	3-7/8	5-39/64	10-5/32	#4	1/8	2T-3SR	22010S-004I	
	Intermediate	4-3/4	5-7/8	7-39/64	11-5/32	#3	1/8	2T-3SR	23010S-003I	
	Standard	6-3/4	7-7/8	9-39/64	13-5/32	#3	1/8	2T-3SR	24010S-003I	
	Standard	6-3/4	7-7/8	9-43/64	14-5/32	#4	1/8	2T-3SR	24010S-004I	
1.5	Extended	10-3/4	11-7/8	13-39/64	17-5/32	#3	1/8	2T-3SR	25010S-003I	
	Short	2-3/4	3-7/8	5-39/64	9-5/32	#3	1/8	2T-3SR	22015S-003I	
	Short	2-3/4	3-7/8	5-39/64	10-5/32	#4	1/8	2T-3SR	22015S-004I	
	Intermediate	4-3/4	5-7/8	7-39/64	11-5/32	#3	1/8	2T-3SR	23015S-003I	
	Standard	6-3/4	7-7/8	9-39/64	13-5/32	#3	1/8	2T-3SR	24015S-003I	
	Standard	6-3/4	7-7/8	9-39/64	14-5/32	#4	1/8	2T-3SR	24015S-004I	
m	1	Short	69.8	98.4	142.5	232.5	#3**	1/8*	2T-3SRM	22010S-003M
	1.5	Short	69.8	98.4	142.5	232.5	#3**	1/8*	2T-3SRM	22015S-003M

\*Metric thread to BSP and ISO 7-1

\*\*Per ISO 296 type BEK

**NOTE:** 1.5 series inserts fit into both 1 and 1.5 series holders. However, 1 series inserts ONLY fit into 1 series holders. See page A30: 7 for visual.

### Connection Accessories

Series	Insert Screws	Nylon Locking Screws	Insert Driver	Preset Torque Hand Driver	Replacement Tips	Admissible Tightening Torque*
1	7375-IP9-1	7375N-IP9-1	8IP-9	8IP-9TL	8IP-9B	27.0 in-lbs (305 N-cm)
1.5	739-IP9-1	739N-IP9-1	8IP-9	8IP-9TL	8IP-9B	27.0 in-lbs (305 N-cm)

\*Tightening torques are calculated with a friction coefficient of  $\mu = 0.14$  and develop 90% of ultimate yield strength

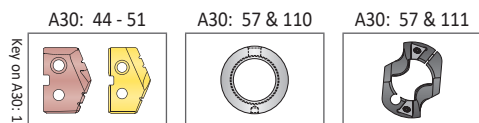

Key on A30: 1

i = Imperial (in)

m = Metric (mm)

Screws sold in quantities of 10

**WARNING** Refer to Speed and Feed charts for recommended adjustments to speeds and feeds. Refer to page A30: 146 for deep hole drilling guidelines in this section of the catalog. Visit [www.alliedmachine.com/DeepHoleGuidelines](http://www.alliedmachine.com/DeepHoleGuidelines) for the most up-to-date information and procedures. Factory technical assistance is available for your specific applications through our Application Engineering Team.

## T-A® Drill Insert Holders

1 Series | Taper Shank | Diameter Range: 0.690" - 0.960" (17.53 mm - 24.38 mm)

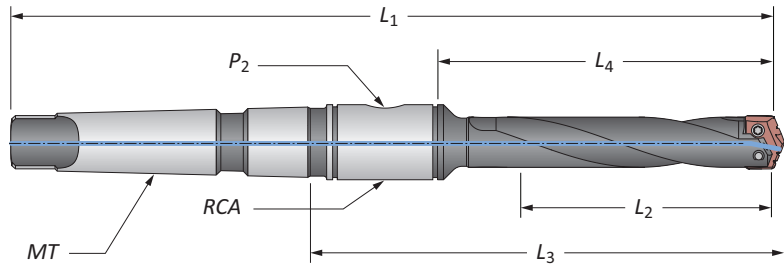

### Helical Flute

Series	Length	Body				Shank			Part No.	
		L <sub>2</sub>	L <sub>4</sub>	L <sub>3</sub>	L <sub>1</sub>	MT	P <sub>2</sub>	RCA		
i	1	Intermediate	4-3/4	5-7/8	7-39/64	11-5/32	#3	1/8	2T-3SR	23010H-003I
		Standard	6-3/4	7-7/8	9-39/64	13-5/32	#3	1/8	2T-3SR	24010H-003I
		Standard	6-3/4	7-7/8	9-43/64	14-5/32	#4	1/8	2T-3SR	24010H-004I
		Extended	10-3/4	11-7/8	13-39/64	17-5/32	#3	1/8	2T-3SR	25010H-003I
i	1.5	Intermediate	4-3/4	5-7/8	7-39/64	11-5/32	#3	1/8	2T-3SR	23015H-003I
		Standard	6-3/4	7-7/8	9-39/64	13-5/32	#3	1/8	2T-3SR	24015H-003I
		Standard	6-3/4	7-7/8	9-43/64	14-5/32	#4	1/8	2T-3SR	24015H-004I
		Extended	10-3/4	11-7/8	13-39/64	17-5/32	#3	1/8	2T-3SR	25015H-003I
m	1	Intermediate	120.7	149.2	193.3	283.3	#3**	1/8*	2T-3SRM	23010H-003M
		Standard	171.5	200.0	244.1	334.2	#3**	1/8*	2T-3SRM	24010H-003M
		Extended	273.1	301.6	345.7	435.8	#3**	1/8*	2T-3SRM	25010H-003M
	1.5	Intermediate	120.7	149.2	193.3	283.3	#3**	1/8*	2T-3SRM	23015H-003M
		Standard	171.5	200.0	244.1	334.2	#3**	1/8*	2T-3SRM	24015H-003M
		Extended	273.1	301.6	345.7	435.8	#3**	1/8*	2T-3SRM	25015H-003M

\*Metric thread to BSP and ISO 7-1

\*\*Per ISO 296 type BEK

**NOTE:** 1.5 series inserts fit into both 1 and 1.5 series holders. However, 1 series inserts ONLY fit into 1 series holders. See page A30: 7 for visual.

### Connection Accessories

Series	Insert Screws	Nylon Locking Screws	Insert Driver	Preset Torque Hand Driver	Replacement Tips	Admissible Tightening Torque*
1	7375-IP9-1	7375N-IP9-1	8IP-9	8IP-9TL	8IP-9B	27.0 in-lbs (305 N-cm)
1.5	739-IP9-1	739N-IP9-1	8IP-9	8IP-9TL	8IP-9B	27.0 in-lbs (305 N-cm)

\*Tightening torques are calculated with a friction coefficient of  $\mu = 0.14$  and develop 90% of ultimate yield strength

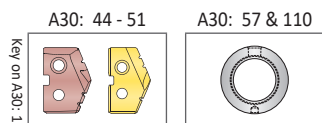

i = Imperial (in)  
m = Metric (mm)

Screws sold in quantities of 10

**WARNING** Refer to Speed and Feed charts for recommended adjustments to speeds and feeds. Refer to page A30: 146 for deep hole drilling guidelines in this section of the catalog. Visit [www.alliedmachine.com/DeepHoleGuidelines](http://www.alliedmachine.com/DeepHoleGuidelines) for the most up-to-date information and procedures. Factory technical assistance is available for your specific applications through our Application Engineering Team.

## T-A® Drill Insert Holders

1 Series | Straight Shank | Diameter Range: 0.690" - 0.960" (17.53 mm - 24.38 mm)

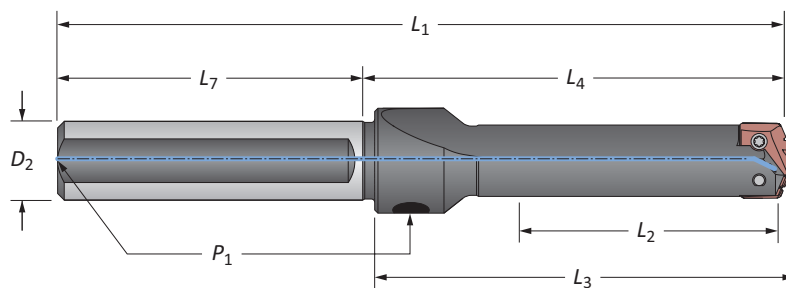

### Straight Flute

Series	Length	Body				Shank			Part No.
		L <sub>2</sub>	L <sub>4</sub>	L <sub>3</sub>	L <sub>1</sub>	D <sub>2</sub>	L <sub>7</sub>	P <sub>1</sub>	
1	Short	2-5/8	3-7/8	4-1/64	6-7/8	3/4	3	1/8	22010S-075L
	Short	2-5/8	3-7/8	4-1/64	6-7/8	1	3	1/8	22010S-100L
	Intermediate	4-5/8	5-7/8	6-1/64	8-7/8	1	3	1/8	23010S-100L
	Standard	6-5/8	7-7/8	8-1/64	10-7/8	3/4	3	1/8	24010S-075L
	Standard	6-5/8	7-7/8	8-1/64	10-7/8	1	3	1/8	24010S-100L
	Extended	10-5/8	11-7/8	12-1/64	14-7/8	1	3	1/8	25010S-100L
	XL	18	19-1/4	19-25/64	22-1/4	1	3	1/8	27010S-100L
1.5	3XL	22-1/4	23-1/2	23-41/64	26-1/2	1	3	1/8	29010S-100L
	Short	2-5/8	3-7/8	4-1/64	6-7/8	3/4	3	1/8*	22015S-075L
	Short	2-5/8	3-7/8	4-1/64	6-7/8	1	3	1/8*	22015S-100L
	Intermediate	4-5/8	5-7/8	6-1/64	8-7/8	1	3	1/8*	23015S-100L
	Standard	6-5/8	7-7/8	8-1/64	10-7/8	3/4	3	1/8*	24015S-075L
	Standard	6-5/8	7-7/8	8-1/64	10-7/8	1	3	1/8*	24015S-100L
	Extended	10-5/8	11-7/8	12-1/64	14-7/8	1	3	1/8*	25015S-100L

**NOTE:** 1.5 series inserts fit into both 1 and 1.5 series holders. However, 1 series inserts ONLY fit into 1 series holders. See page A30: 7 for visual.

### Connection Accessories

Series	Insert Screws	Nylon Locking Screws	Insert Driver	Preset Torque Hand Driver	Replacement Tips	Admissible Tightening Torque*
1	7375-IP9-1	7375N-IP9-1	8IP-9	8IP-9TL	8IP-9B	27.0 in-lbs (305 N-cm)
1.5	739-IP9-1	739N-IP9-1	8IP-9	8IP-9TL	8IP-9B	27.0 in-lbs (305 N-cm)

\*Tightening torques are calculated with a friction coefficient of  $\mu = 0.14$  and develop 90% of ultimate yield strength

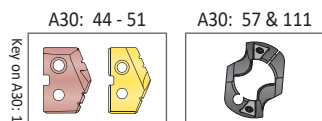

Key on A30: 1

**i** = Imperial (in)

**m** = Metric (mm)

Screws sold in quantities of 10

**WARNING** Refer to Speed and Feed charts for recommended adjustments to speeds and feeds. Refer to page A30: 146 for deep hole drilling guidelines in this section of the catalog. Visit [www.alliedmachine.com/DeepHoleGuidelines](http://www.alliedmachine.com/DeepHoleGuidelines) for the most up-to-date information and procedures. Factory technical assistance is available for your specific applications through our Application Engineering Team.



T-A® Drill Accessories

1 Series | Chamfer Rings | Rotary Coolant Adapters | Torx® Plus Screws |

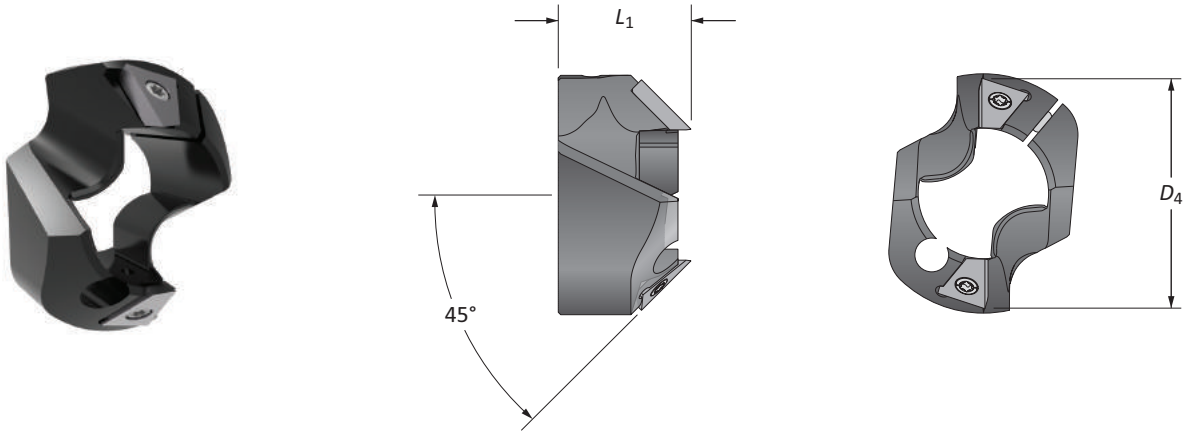

T-ACR 45 Chamfer Ring

Holder Series	D <sub>1</sub> Range	Chamfer Ring		Part No.	Insert Part No.	Insert Screw	Insert Driver	Clamping Screw	Insert Driver
		D <sub>4</sub>	L <sub>1</sub>						
1	0.6900 - 0.9600	1-3/64	51/64	T-ACR-45-1	T-ACRI-45-B-C5A	7255-IP8-1	8IP-8	7495-IP15-1	8IP-15
1.5	0.8540 - 0.9600	1-1/8	57/64	T-ACR-45-1.5	T-ACRI-45-B-C5A	7255-IP8-1	8IP-8	7495-IP15-1	8IP-15

Rotary Coolant Adapter (RCA) and Accessories

ID	OD	L <sub>1</sub>	Driving Rod Thread	P <sub>1</sub>	Part No.	RCA O-Rings	
						Kit Part No.**	Replacements
1	2-1/8	1-1/8	5/16-18	1/8	2T-3SR	2T1-3SR	2T1-3OR-10
25.40	53.97	28.57	M8 x 1.25	1/8*	2T-3SRM	2T1-3SR	2T1-3OR-10

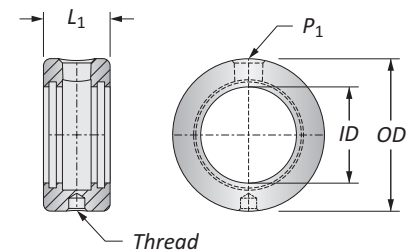

\*Thread to BSP and ISO 7-1

\*\*RCA Repair Kit includes (2) O-rings, (2) snap rings, and (2) thrust washers

▲ Refer to page A30: 110 for proper RCA assembly and safety information

Connection Accessories

Series	Insert Screws	Nylon Locking Screws	Insert Driver	Preset Torque Hand Driver	Replacement Tips	Admissible Tightening Torque*
1	7375-IP9-1	7375N-IP9-1	8IP-9	8IP-9TL	8IP-9B	27.0 in-lbs (305 N-cm)
1.5	739-IP9-1	739N-IP9-1	8IP-9	8IP-9TL	8IP-9B	27.0 in-lbs (305 N-cm)

\*Tightening torques are calculated with a friction coefficient of  $\mu = 0.14$  and develop 90% of ultimate yield strength

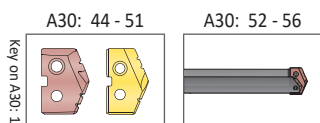

ⓘ = Imperial (in)  
 Ⓜ = Metric (mm)

Chamfer Ring Inserts sold separately  
 Screws sold in packs of 10  
 O-rings sold in packs of 10

**WARNING** RCA rotation during drilling can cause hose and/or hose fitting failure, machinery damage, and/or serious injury. To prevent, use RCA and positive stop studs when drilling. Factory technical assistance is also available for your specific applications.



A DRILLING  
 B BORING  
 C REAMING  
 D BURNISHING  
 E THREADING  
 X SPECIALS

## GEN2 T-A® Drill Inserts

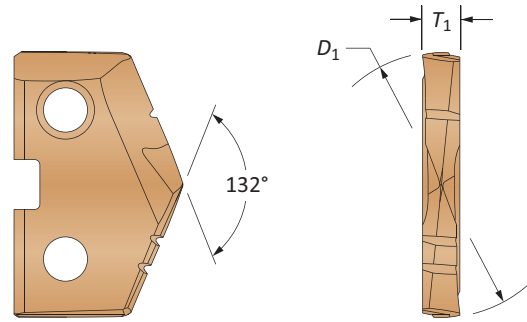
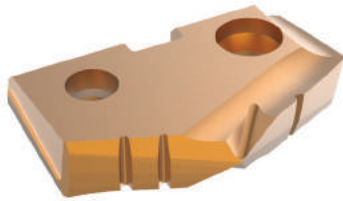
2 Series | Diameter Range: 0.961" - 1.380" (24.41 mm - 35.05 mm)



HSS Inserts – Super Cobalt • Carbide Inserts – C2 (K20) | C1 (K35)

Series	Fractional Equivalent	Insert			HSS Part No.	Carbide Part No.	
		$D_1$ inch	$D_1$ mm	$T_1$	 AM200® Super Cobalt	 AM300® C2 (K20)	 AM300® C1 (K35)
2	-	0.9646	24.50	3/16	452H-24.5	4C22P-24.5	4C12P-24.5
	31/32	0.9688	24.61	3/16	452H-0031	4C22P-0031	4C12P-0031
	-	0.9760	24.79	3/16	452H-.976	4C22P-.976	4C12P-.976
	63/64	0.9843	25.00	3/16	452H-25	4C22P-25	4C12P-25
	1	1.0000	25.40	3/16	452H-0100	4C22P-0100	4C12P-0100
	-	1.0039	25.50	3/16	452H-25.5	4C22P-25.5	4C12P-25.5
	1-1/64	1.0156	25.80	3/16	452H-1.015	4C22P-1.015	4C12P-1.015
	-	1.0236	26.00	3/16	452H-26	4C22P-26	4C12P-26
	1-1/32	1.0313	26.19	3/16	452H-0101	4C22P-0101	4C12P-0101
	-	1.0433	26.50	3/16	452H-26.5	4C22P-26.5	4C12P-26.5
	1-3/64	1.0469	26.59	3/16	452H-1.046	4C22P-1.046	4C12P-1.046
	1-1/16	1.0625	26.99	3/16	452H-0102	4C22P-0102	4C12P-0102
	-	1.0630	27.00	3/16	452H-27	4C22P-27	4C12P-27
	-	1.0827	27.50	3/16	452H-27.5	4C22P-27.5	4C12P-27.5
	1-3/32	1.0938	27.78	3/16	452H-0103	4C22P-0103	4C12P-0103
	-	1.1024	28.00	3/16	452H-28	4C22P-28	4C12P-28
	1-7/64	1.1094	28.18	3/16	452H-1.109	4C22P-1.109	4C12P-1.109
	-	1.1220	28.50	3/16	452H-28.5	4C22P-28.5	4C12P-28.5
	1-1/8	1.1250	28.58	3/16	452H-0104	4C22P-0104	4C12P-0104
	-	1.1417	29.00	3/16	452H-29	4C22P-29	4C12P-29
1-5/32	1.1563	29.37	3/16	452H-0105	4C22P-0105	4C12P-0105	
-	1.1614	29.50	3/16	452H-29.5	4C22P-29.5	4C12P-29.5	
-	1.1811	30.00	3/16	452H-30	4C22P-30	4C12P-30	
2.5	1-3/16	1.1875	30.16	3/16	452H-0106	4C22P-0106	4C12P-0106
	-	1.2008	30.50	3/16	452H-30.5	4C22P-30.5	4C12P-30.5
	1-7/32	1.2188	30.96	3/16	452H-0107	4C22P-0107	4C12P-0107
	-	1.2205	31.00	3/16	452H-31	4C22P-31	4C12P-31
	-	1.2260	31.14	3/16	452H-1.226	4C22P-1.226	4C12P-1.226
	-	1.2310	31.26	3/16	452H-1.231	4C22P-1.231	4C12P-1.231
	-	1.2340	31.34	3/16	452H-1.234	4C22P-1.234	4C12P-1.234
	-	1.2402	31.50	3/16	452H-31.5	4C22P-31.5	4C12P-31.5
	1-1/4	1.2500	31.75	3/16	452H-0108	4C22P-0108	4C12P-0108
	-	1.2598	32.00	3/16	452H-32	4C22P-32	4C12P-32
	-	1.2795	32.50	3/16	452H-32.5	4C22P-32.5	4C12P-32.5
	1-9/32	1.2813	32.54	3/16	452H-0109	4C22P-0109	4C12P-0109
	-	1.2992	33.00	3/16	452H-33	4C22P-33	4C12P-33
	1-5/16	1.3125	33.34	3/16	452H-0110	4C22P-0110	4C12P-0110
	-	1.3189	33.50	3/16	452H-33.5	4C22P-33.5	4C12P-33.5
	-	1.3386	34.00	3/16	452H-34	4C22P-34	4C12P-34
	1-11/32	1.3438	34.13	3/16	452H-0111	4C22P-0111	4C12P-0111
	-	1.3582	34.50	3/16	452H-34.5	4C22P-34.5	4C12P-34.5
	1-3/8	1.3750	34.93	3/16	452H-0112	4C22P-0112	4C12P-0112
	-	1.3780	35.00	3/16	452H-35	4C22P-35	4C12P-35

**NOTE:** 2.5 series inserts fit into both 2 and 2.5 series holders. However, 2 series inserts ONLY fit into 2 series holders. See page A30: 7 for visual.

Inserts sold in quantities of 2

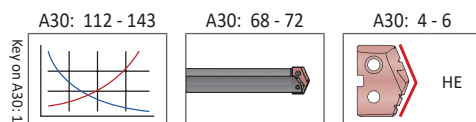

Coatings not listed above can be supplied as non-stocked standards. Process fees apply. →



TiN = 452T-XXXX	TiAlN = 452A-XXXX
TiCN = 452N-XXXX	AM200® = 452H-XXXX

T-A® Drill Inserts

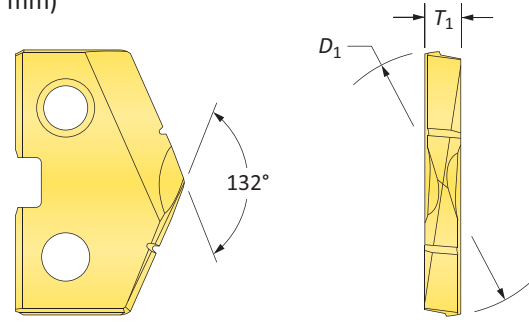

2 Series | HSS | Diameter Range: 0.961" - 1.380" (24.41 mm - 35.05 mm)



HSS Inserts – Premium Cobalt

Series	Fractional Equivalent	Insert			Part No.		
		D <sub>1</sub> inch	D <sub>1</sub> mm	T <sub>1</sub>	 TiN	 TiAlN	 TiCN
2	–	0.9646	24.50	3/16	182T-24.5	182A-24.5	182N-24.5
	31/32	0.9688	24.61	3/16	182T-0031	182A-0031	182N-0031
	–	0.9760	24.79	3/16	182T-.976	182A-.976	182N-.976
	63/64	0.9843	25.00	3/16	182T-25	182A-25	182N-25
	1	1.0000	25.40	3/16	182T-0100	182A-0100	182N-0100
	–	1.0039	25.50	3/16	182T-25.5	182A-25.5	182N-25.5
	1-1/64	1.0156	25.80	3/16	182T-1.015	182A-1.015	182N-1.015
	–	1.0236	26.00	3/16	182T-26	182A-26	182N-26
	1-1/32	1.0313	26.19	3/16	182T-0101	182A-0101	182N-0101
	–	1.0433	26.50	3/16	182T-26.5	182A-26.5	182N-26.5
	1-3/64	1.0469	26.59	3/16	182T-1.046	182A-1.046	182N-1.046
	1-1/16	1.0625	26.99	3/16	182T-0102	182A-0102	182N-0102
	–	1.0630	27.00	3/16	182T-27	182A-27	182N-27
	–	1.0827	27.50	3/16	182T-27.5	182A-27.5	182N-27.5
	1-3/32	1.0938	27.78	3/16	182T-0103	182A-0103	182N-0103
	–	1.1024	28.00	3/16	182T-28	182A-28	182N-28
	1-7/64	1.1094	28.18	3/16	182T-1.109	182A-1.109	182N-1.109
	–	1.1220	28.50	3/16	182T-28.5	182A-28.5	182N-28.5
	1-1/8	1.1250	28.58	3/16	182T-0104	182A-0104	182N-0104
	–	1.1417	29.00	3/16	182T-29	182A-29	182N-29
1-5/32	1.1563	29.37	3/16	182T-0105	182A-0105	182N-0105	
–	1.1614	29.50	3/16	182T-29.5	182A-29.5	182N-29.5	
–	1.1811	30.00	3/16	182T-30	182A-30	182N-30	
2.5	1-3/16	1.1875	30.16	3/16	182T-0106	182A-0106	182N-0106
	–	1.2008	30.50	3/16	182T-30.5	182A-30.5	182N-30.5
	1-7/32	1.2188	30.96	3/16	182T-0107	182A-0107	182N-0107
	–	1.2205	31.00	3/16	182T-31	182A-31	182N-31
	–	1.2260	31.14	3/16	182T-1.226	182A-1.226	182N-1.226
	–	1.2310	31.26	3/16	182T-1.231	182A-1.231	182N-1.231
	–	1.2340	31.34	3/16	182T-1.234	182A-1.234	182N-1.234
	–	1.2402	31.50	3/16	182T-31.5	182A-31.5	182N-31.5
	1-1/4	1.2500	31.75	3/16	182T-0108	182A-0108	182N-0108
	–	1.2598	32.00	3/16	182T-32	182A-32	182N-32
	–	1.2795	32.50	3/16	182T-32.5	182A-32.5	182N-32.5
	1-9/32	1.2813	32.54	3/16	182T-0109	182A-0109	182N-0109
	–	1.2992	33.00	3/16	182T-33	182A-33	182N-33
	1-5/16	1.3125	33.34	3/16	182T-0110	182A-0110	182N-0110
	–	1.3189	33.50	3/16	182T-33.5	182A-33.5	182N-33.5
	–	1.3386	34.00	3/16	182T-34	182A-34	182N-34
	1-11/32	1.3438	34.13	3/16	182T-0111	182A-0111	182N-0111
	–	1.3582	34.50	3/16	182T-34.5	182A-34.5	182N-34.5
	1-3/8	1.3750	34.93	3/16	182T-0112	182A-0112	182N-0112
	–	1.3780	35.00	3/16	182T-35	182A-35	182N-35

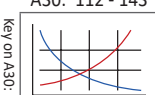
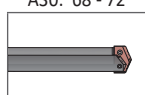
NOTE: 2.5 series inserts fit into both 2 and 2.5 series holders. However, 2 series inserts ONLY fit into 2 series holders. See page A30: 7 for visual.

A30: 112 - 143  A30: 68 - 72  A30: 4 - 6  HI, HR, CR, TC, SK, NP, IN, RN, CN, AN, BR, CI, CP, NC, WC

Coatings not listed above can be supplied as non-stocked standards. Process fees apply. →

TiN = 182T-XXXX	TiAlN = 182A-XXXX
TiCN = 182N-XXXX	AM200® = 182H-XXXX



Inserts sold in quantities of 2

## T-A® Drill Inserts

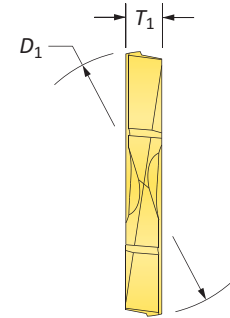
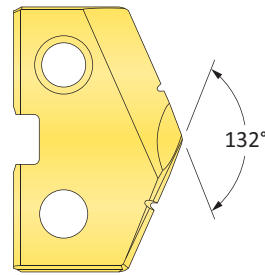
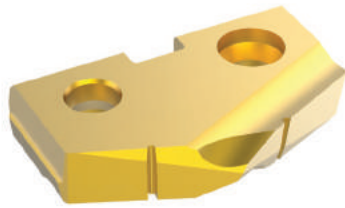
2 Series | HSS | Diameter Range: 0.961" - 1.380" (24.41 mm - 35.05 mm)



### HSS Inserts – Super Cobalt

Series	Fractional Equivalent	Insert			Part No.		
		$D_1$ inch	$D_1$ mm	$T_1$	 TiN	 TiAlN	 TiCN
2	-	0.9646	24.50	3/16	152T-24.5	152A-24.5	152N-24.5
	31/32	0.9688	24.61	3/16	152T-0031	152A-0031	152N-0031
	-	0.9760	24.79	3/16	152T-.976	152A-.976	152N-.976
	63/64	0.9843	25.00	3/16	152T-25	152A-25	152N-25
	1	1.0000	25.40	3/16	152T-0100	152A-0100	152N-0100
	-	1.0039	25.50	3/16	152T-25.5	152A-25.5	152N-25.5
	1-1/64	1.0156	25.80	3/16	152T-1.015	152A-1.015	152N-1.015
	-	1.0236	26.00	3/16	152T-26	152A-26	152N-26
	1-1/32	1.0313	26.19	3/16	152T-0101	152A-0101	152N-0101
	-	1.0433	26.50	3/16	152T-26.5	152A-26.5	152N-26.5
	1-3/64	1.0469	26.59	3/16	152T-1.046	152A-1.046	152N-1.046
	1-1/16	1.0625	26.99	3/16	152T-0102	152A-0102	152N-0102
	-	1.0630	27.00	3/16	152T-27	152A-27	152N-27
	-	1.0827	27.50	3/16	152T-27.5	152A-27.5	152N-27.5
	1-3/32	1.0938	27.78	3/16	152T-0103	152A-0103	152N-0103
	-	1.1024	28.00	3/16	152T-28	152A-28	152N-28
	1-7/64	1.1094	28.18	3/16	152T-1.109	152A-1.109	152N-1.109
	-	1.1220	28.50	3/16	152T-28.5	152A-28.5	152N-28.5
	1-1/8	1.1250	28.58	3/16	152T-0104	152A-0104	152N-0104
	-	1.1417	29.00	3/16	152T-29	152A-29	152N-29
1-5/32	1.1563	29.37	3/16	152T-0105	152A-0105	152N-0105	
-	1.1614	29.50	3/16	152T-29.5	152A-29.5	152N-29.5	
-	1.1811	30.00	3/16	152T-30	152A-30	152N-30	
2.5	1-3/16	1.1875	30.16	3/16	152T-0106	152A-0106	152N-0106
	-	1.2008	30.50	3/16	152T-30.5	152A-30.5	152N-30.5
	1-7/32	1.2188	30.96	3/16	152T-0107	152A-0107	152N-0107
	-	1.2205	31.00	3/16	152T-31	152A-31	152N-31
	-	1.2260	31.14	3/16	152T-1.226	152A-1.226	152N-1.226
	-	1.2310	31.26	3/16	152T-1.231	152A-1.231	152N-1.231
	-	1.2340	31.34	3/16	152T-1.234	152A-1.234	152N-1.234
	-	1.2402	31.50	3/16	152T-31.5	152A-31.5	152N-31.5
	1-1/4	1.2500	31.75	3/16	152T-0108	152A-0108	152N-0108
	-	1.2598	32.00	3/16	152T-32	152A-32	152N-32
	-	1.2795	32.50	3/16	152T-32.5	152A-32.5	152N-32.5
	1-9/32	1.2813	32.54	3/16	152T-0109	152A-0109	152N-0109
	-	1.2992	33.00	3/16	152T-33	152A-33	152N-33
	1-5/16	1.3125	33.34	3/16	152T-0110	152A-0110	152N-0110
	-	1.3189	33.50	3/16	152T-33.5	152A-33.5	152N-33.5
	-	1.3386	34.00	3/16	152T-34	152A-34	152N-34
	1-11/32	1.3438	34.13	3/16	152T-0111	152A-0111	152N-0111
	-	1.3582	34.50	3/16	152T-34.5	152A-34.5	152N-34.5
	1-3/8	1.3750	34.93	3/16	152T-0112	152A-0112	152N-0112
	-	1.3780	35.00	3/16	152T-35	152A-35	152N-35

**NOTE:** 2.5 series inserts fit into both 2 and 2.5 series holders. However, 2 series inserts ONLY fit into 2 series holders. See page A30: 7 for visual.

Inserts sold in quantities of 2

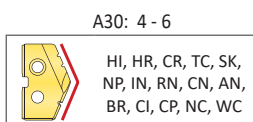
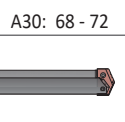
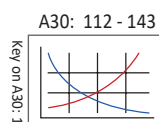

Coatings not listed above can be supplied as non-stocked standards. Process fees apply. →

TiN = 152T-XXXX	TiAlN = 152A-XXXX
TiCN = 152N-XXXX	AM200® = 152H-XXXX

T-A® Drill Inserts



2 Series | HSS | Diameter Range: 0.961" - 1.380" (24.41 mm - 35.05 mm)

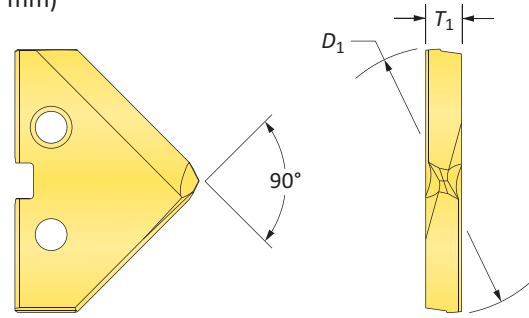

90° Spot & Chamfer



HSS Inserts – Super Cobalt

Series	Fractional Equivalent	Insert			90° Spot & Chamfer Part No.		
		D <sub>1</sub> inch	D <sub>1</sub> mm	T <sub>1</sub>	 TiN	 TiAlN	 TiCN
2	–	0.9646	24.50	3/16	152T-24.5-SP	152A-24.5-SP	152N-24.5-SP
	31/32	0.9688	24.61	3/16	152T-0031-SP	152A-0031-SP	152N-0031-SP
	–	0.9760	24.79	3/16	152T-.976-SP	152A-.976-SP	152N-.976-SP
	63/64	0.9843	25.00	3/16	152T-25-SP	152A-25-SP	152N-25-SP
	1	1.0000	25.40	3/16	152T-0100-SP	152A-0100-SP	152N-0100-SP
	–	1.0039	25.50	3/16	152T-25.5-SP	152A-25.5-SP	152N-25.5-SP
	1-1/64	1.0156	25.80	3/16	152T-1.015-SP	152A-1.015-SP	152N-1.015-SP
	–	1.0236	26.00	3/16	152T-26-SP	152A-26-SP	152N-26-SP
	1-1/32	1.0313	26.19	3/16	152T-0101-SP	152A-0101-SP	152N-0101-SP
	–	1.0433	26.50	3/16	152T-26.5-SP	152A-26.5-SP	152N-26.5-SP
	1-3/64	1.0469	26.59	3/16	152T-1.046-SP	152A-1.046-SP	152N-1.046-SP
	1-1/16	1.0625	26.99	3/16	152T-0102-SP	152A-0102-SP	152N-0102-SP
	–	1.0630	27.00	3/16	152T-27-SP	152A-27-SP	152N-27-SP
	–	1.0827	27.50	3/16	152T-27.5-SP	152A-27.5-SP	152N-27.5-SP
	1-3/32	1.0938	27.78	3/16	152T-0103-SP	152A-0103-SP	152N-0103-SP
	–	1.1024	28.00	3/16	152T-28-SP	152A-28-SP	152N-28-SP
	1-7/64	1.1094	28.18	3/16	152T-1.109-SP	152A-1.109-SP	152N-1.109-SP
	–	1.1220	28.50	3/16	152T-28.5-SP	152A-28.5-SP	152N-28.5-SP
	1-1/8	1.1250	28.58	3/16	152T-0104-SP	152A-0104-SP	152N-0104-SP
	–	1.1417	29.00	3/16	152T-29-SP	152A-29-SP	152N-29-SP
1-5/32	1.1563	29.37	3/16	152T-0105-SP	152A-0105-SP	152N-0105-SP	
–	1.1614	29.50	3/16	152T-29.5-SP	152A-29.5-SP	152N-29.5-SP	
–	1.1811	30.00	3/16	152T-30-SP	152A-30-SP	152N-30-SP	
2.5	1-3/16	1.1875	30.16	3/16	152T-0106-SP	152A-0106-SP	152N-0106-SP
	–	1.2008	30.50	3/16	152T-30.5-SP	152A-30.5-SP	152N-30.5-SP
	1-7/32	1.2188	30.96	3/16	152T-0107-SP	152A-0107-SP	152N-0107-SP
	–	1.2205	31.00	3/16	152T-31-SP	152A-31-SP	152N-31-SP
	–	1.2260	31.14	3/16	152T-1.226-SP	152A-1.226-SP	152N-1.226-SP
	–	1.2310	31.26	3/16	152T-1.231-SP	152A-1.231-SP	152N-1.231-SP
	–	1.2340	31.34	3/16	152T-1.234-SP	152A-1.234-SP	152N-1.234-SP
	–	1.2402	31.50	3/16	152T-31.5-SP	152A-31.5-SP	152N-31.5-SP
	1-1/4	1.2500	31.75	3/16	152T-0108-SP	152A-0108-SP	152N-0108-SP
	–	1.2598	32.00	3/16	152T-32-SP	152A-32-SP	152N-32-SP
	–	1.2795	32.50	3/16	152T-32.5-SP	152A-32.5-SP	152N-32.5-SP
	1-9/32	1.2813	32.54	3/16	152T-0109-SP	152A-0109-SP	152N-0109-SP
	–	1.2992	33.00	3/16	152T-33-SP	152A-33-SP	152N-33-SP
	1-5/16	1.3125	33.34	3/16	152T-0110-SP	152A-0110-SP	152N-0110-SP
	–	1.3189	33.50	3/16	152T-33.5-SP	152A-33.5-SP	152N-33.5-SP
	–	1.3386	34.00	3/16	152T-34-SP	152A-34-SP	152N-34-SP
	1-11/32	1.3438	34.13	3/16	152T-0111-SP	152A-0111-SP	152N-0111-SP
	–	1.3582	34.50	3/16	152T-34.5-SP	152A-34.5-SP	152N-34.5-SP
	1-3/8	1.3750	34.93	3/16	152T-0112-SP	152A-0112-SP	152N-0112-SP
	–	1.3780	35.00	3/16	152T-35-SP	152A-35-SP	152N-35-SP

NOTE: 2.5 series inserts fit into both 2 and 2.5 series holders. However, 2 series inserts ONLY fit into 2 series holders. See page A30: 7 for visual.

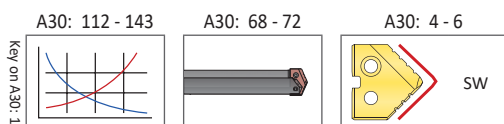

Inserts sold in quantities of 2

Coatings not listed above can be supplied as non-stocked standards. Process fees apply. →

TiN = 152T-XXXX	TiAlN = 152A-XXXX
TiCN = 152N-XXXX	AM200® = 152H-XXXX

## T-A® Drill Inserts

2 Series | HSS | Diameter Range: 0.961" - 1.380" (24.41 mm - 35.05 mm)



Flat Bottom

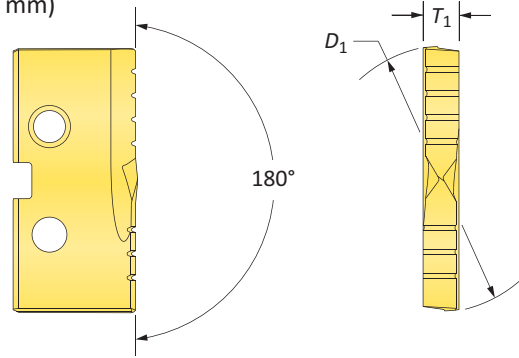

### HSS Inserts – Super Cobalt

Series	Fractional Equivalent	Insert			Flat Bottom Part No.
		$D_1$ inch	$D_1$ mm	$T_1$	TiN 
2	-	0.9646	24.50	3/16	152T-24.5-FB
	31/32	0.9688	24.61	3/16	152T-0031-FB
	-	0.9760	24.79	3/16	152T-.976-FB
	63/64	0.9843	25.00	3/16	152T-25-FB
	1	1.0000	25.40	3/16	152T-0100-FB
	-	1.0039	25.50	3/16	152T-25.5-FB
	1-1/64	1.0156	25.80	3/16	152T-1.015-FB
	-	1.0236	26.00	3/16	152T-26-FB
	1-1/32	1.0313	26.19	3/16	152T-0101-FB
	-	1.0433	26.50	3/16	152T-26.5-FB
	1-3/64	1.0469	26.59	3/16	152T-1.046-FB
	1-1/16	1.0625	26.99	3/16	152T-0102-FB
	-	1.0630	27.00	3/16	152T-27-FB
	-	1.0827	27.50	3/16	152T-27.5-FB
	1-3/32	1.0938	27.78	3/16	152T-0103-FB
	-	1.1024	28.00	3/16	152T-28-FB
	1-7/64	1.1094	28.18	3/16	152T-1.109-FB
	-	1.1220	28.50	3/16	152T-28.5-FB
	1-1/8	1.1250	28.58	3/16	152T-0104-FB
	-	1.1417	29.00	3/16	152T-29-FB
1-5/32	1.1563	29.37	3/16	152T-0105-FB	
-	1.1614	29.50	3/16	152T-29.5-FB	
-	1.1811	30.00	3/16	152T-30-FB	
2.5	1-3/16	1.1875	30.16	3/16	152T-0106-FB
	-	1.2008	30.50	3/16	152T-30.5-FB
	1-7/32	1.2188	30.96	3/16	152T-0107-FB
	-	1.2205	31.00	3/16	152T-31-FB
	-	1.2260	31.14	3/16	152T-1.226-FB
	-	1.2310	31.26	3/16	152T-1.231-FB
	-	1.2340	31.34	3/16	152T-1.234-FB
	-	1.2402	31.50	3/16	152T-31.5-FB
	1-1/4	1.2500	31.75	3/16	152T-0108-FB
	-	1.2598	32.00	3/16	152T-32-FB
	-	1.2795	32.50	3/16	152T-32.5-FB
	1-9/32	1.2813	32.54	3/16	152T-0109-FB
	-	1.2992	33.00	3/16	152T-33-FB
	1-5/16	1.3125	33.34	3/16	152T-0110-FB
	-	1.3189	33.50	3/16	152T-33.5-FB
	-	1.3386	34.00	3/16	152T-34-FB
	1-11/32	1.3438	34.13	3/16	152T-0111-FB
	-	1.3582	34.50	3/16	152T-34.5-FB
	1-3/8	1.3750	34.93	3/16	152T-0112-FB
	-	1.3780	35.00	3/16	152T-35-FB

**NOTE:** 2.5 series inserts fit into both 2 and 2.5 series holders. However, 2 series inserts ONLY fit into 2 series holders. See page A30: 7 for visual.

Inserts sold in quantities of 2

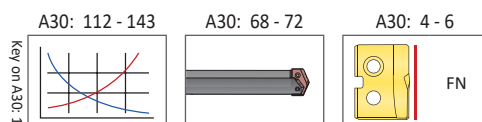

Coatings not listed above can be supplied as non-stocked standards. Process fees apply. →

TiN = 152T-XXXX	TiAlN = 152A-XXXX
TiCN = 152N-XXXX	AM200® = 152H-XXXX



T-A® Drill Inserts

2 Series | HSS | Diameter Range: 0.961" - 1.380" (24.41 mm - 35.05 mm)

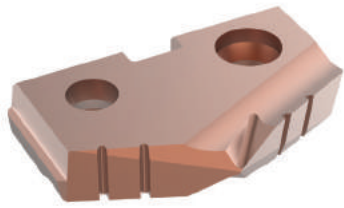

Tube Sheet

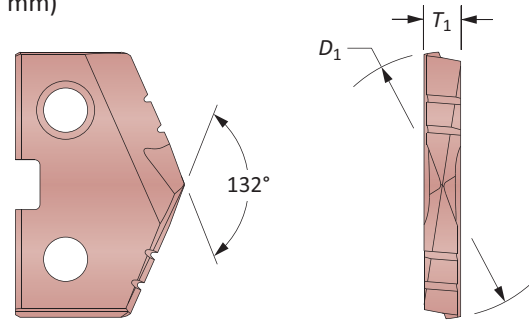

HSS Inserts – Super Cobalt | HSS

Series	Fractional Equivalent	Insert			Part No.	
		$D_1$ inch	$D_1$ mm	$T_1$	Super Cobalt	HSS
2	–	1.0080	25.60	3/16	<b>152H-1.0080-IN</b>	<b>132H-1.0080-IN</b>
	1-1/64	1.0156	25.80	3/16	<b>152H-1.015-IN</b>	<b>132H-1.015-IN</b>
	1-1/32	1.0313	26.19	3/16	<b>152H-0101-IN</b>	<b>132H-0101-IN</b>

A

DRILLING

B

BORING

C

REAMING

D

BURNISHING

E

THREADING

X

SPECIALS

A30: 112 - 143 Key on A30: 1

A30: 68 - 72

Coatings not listed above can be supplied as non-stocked standards. Process fees apply. →

Inserts sold in quantities of 2



TiN = 152T-XXXX	TiAlN = 152A-XXXX
TiCN = 152N-XXXX	AM200® = 152H-XXXX

## T-A® Drill Inserts

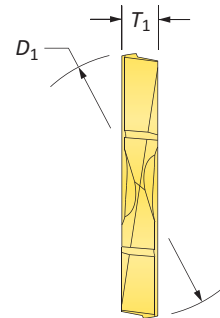
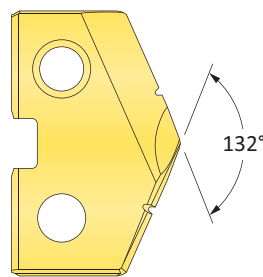
2 Series | HSS | Diameter Range: 0.961" - 1.380" (24.41 mm - 35.05 mm)



### HSS Inserts – HSS

Series	Fractional Equivalent	Insert			Part No.		
		$D_1$ inch	$D_1$ mm	$T_1$	 TiN	 TiAlN	 TiCN
2	-	0.9646	24.50	3/16	132T-24.5	132A-24.5	132N-24.5
	31/32	0.9688	24.61	3/16	132T-0031	132A-0031	132N-0031
	-	0.9760	24.79	3/16	132T-.976	132A-.976	132N-.976
	63/64	0.9843	25.00	3/16	132T-25	132A-25	132N-25
	1	1.0000	25.40	3/16	132T-0100	132A-0100	132N-0100
	-	1.0039	25.50	3/16	132T-25.5	132A-25.5	132N-25.5
	1-1/64	1.0156	25.80	3/16	132T-1.015	132A-1.015	132N-1.015
	-	1.0236	26.00	3/16	132T-26	132A-26	132N-26
	1-1/32	1.0313	26.19	3/16	132T-0101	132A-0101	132N-0101
	-	1.0433	26.50	3/16	132T-26.5	132A-26.5	132N-26.5
	1-3/64	1.0469	26.59	3/16	132T-1.046	132A-1.046	132N-1.046
	1-1/16	1.0625	26.99	3/16	132T-0102	132A-0102	132N-0102
	-	1.0630	27.00	3/16	132T-27	132A-27	132N-27
	-	1.0827	27.50	3/16	132T-27.5	132A-27.5	132N-27.5
	1-3/32	1.0938	27.78	3/16	132T-0103	132A-0103	132N-0103
	-	1.1024	28.00	3/16	132T-28	132A-28	132N-28
	1-7/64	1.1094	28.18	3/16	132T-1.109	132A-1.109	132N-1.109
	-	1.1220	28.50	3/16	132T-28.5	132A-28.5	132N-28.5
	1-1/8	1.1250	28.58	3/16	132T-0104	132A-0104	132N-0104
	-	1.1417	29.00	3/16	132T-29	132A-29	132N-29
1-5/32	1.1563	29.37	3/16	132T-0105	132A-0105	132N-0105	
-	1.1614	29.50	3/16	132T-29.5	132A-29.5	132N-29.5	
-	1.1811	30.00	3/16	132T-30	132A-30	132N-30	
2.5	1-3/16	1.1875	30.16	3/16	132T-0106	132A-0106	132N-0106
	-	1.2008	30.50	3/16	132T-30.5	132A-30.5	132N-30.5
	1-7/32	1.2188	30.96	3/16	132T-0107	132A-0107	132N-0107
	-	1.2205	31.00	3/16	132T-31	132A-31	132N-31
	-	1.2260	31.14	3/16	132T-1.226	132A-1.226	132N-1.226
	-	1.2310	31.26	3/16	132T-1.231	132A-1.231	132N-1.231
	-	1.2340	31.34	3/16	132T-1.234	132A-1.234	132N-1.234
	-	1.2402	31.50	3/16	132T-31.5	132A-31.5	132N-31.5
	1-1/4	1.2500	31.75	3/16	132T-0108	132A-0108	132N-0108
	-	1.2598	32.00	3/16	132T-32	132A-32	132N-32
	-	1.2795	32.50	3/16	132T-32.5	132A-32.5	132N-32.5
	1-9/32	1.2813	32.54	3/16	132T-0109	132A-0109	132N-0109
	-	1.2992	33.00	3/16	132T-33	132A-33	132N-33
	1-5/16	1.3125	33.34	3/16	132T-0110	132A-0110	132N-0110
	-	1.3189	33.50	3/16	132T-33.5	132A-33.5	132N-33.5
	-	1.3386	34.00	3/16	132T-34	132A-34	132N-34
	1-11/32	1.3438	34.13	3/16	132T-0111	132A-0111	132N-0111
	-	1.3582	34.50	3/16	132T-34.5	132A-34.5	132N-34.5
	1-3/8	1.3750	34.93	3/16	132T-0112	132A-0112	132N-0112
	-	1.3780	35.00	3/16	132T-35	132A-35	132N-35

**NOTE:** 2.5 series inserts fit into both 2 and 2.5 series holders. However, 2 series inserts ONLY fit into 2 series holders. See page A30: 7 for visual.

Inserts sold in quantities of 2

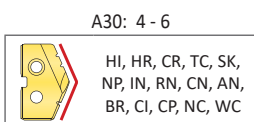
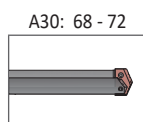
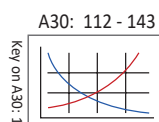

Coatings not listed above  
can be supplied as  
non-stocked standards.  
Process fees apply. →

TiN = 132T-XXXX	TiAlN = 132A-XXXX
TiCN = 132N-XXXX	AM200® = 132H-XXXX



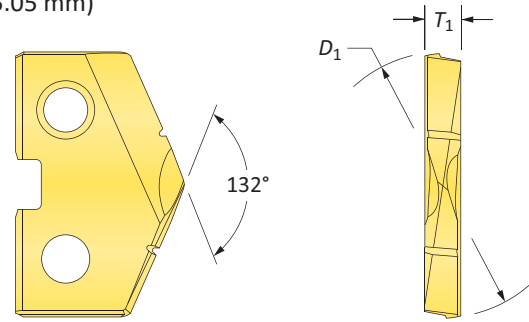
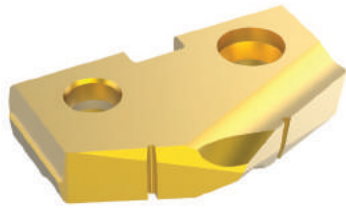

**T-A® Drill Inserts**

2 Series | Carbide | Diameter Range: 0.961" - 1.380" (24.41 mm - 35.05 mm)



**Carbide Inserts – C2 (K20)**

Series	Fractional Equivalent	Insert			Part No.	
		D <sub>1</sub> inch	D <sub>1</sub> mm	T <sub>1</sub>	 TiN	 TiAlN
2	–	0.9646	24.50	3/16	<b>1C22T-24.5</b>	<b>1C22A-24.5</b>
	31/32	0.9688	24.61	3/16	<b>1C22T-0031</b>	<b>1C22A-0031</b>
	–	0.9760	24.79	3/16	<b>1C22T-.976</b>	<b>1C22A-.976</b>
	63/64	0.9843	25.00	3/16	<b>1C22T-25</b>	<b>1C22A-25</b>
	1	1.0000	25.40	3/16	<b>1C22T-0100</b>	<b>1C22A-0100</b>
	–	1.0039	25.50	3/16	<b>1C22T-25.5</b>	<b>1C22A-25.5</b>
	1-1/64	1.0156	25.80	3/16	<b>1C22T-1.015</b>	<b>1C22A-1.015</b>
	–	1.0236	26.00	3/16	<b>1C22T-26</b>	<b>1C22A-26</b>
	1-1/32	1.0313	26.19	3/16	<b>1C22T-0101</b>	<b>1C22A-0101</b>
	–	1.0433	26.50	3/16	<b>1C22T-26.5</b>	<b>1C22A-26.5</b>
	1-3/64	1.0469	26.59	3/16	<b>1C22T-1.046</b>	<b>1C22A-1.046</b>
	1-1/16	1.0625	26.99	3/16	<b>1C22T-0102</b>	<b>1C22A-0102</b>
	–	1.0630	27.00	3/16	<b>1C22T-27</b>	<b>1C22A-27</b>
	–	1.0827	27.50	3/16	<b>1C22T-27.5</b>	<b>1C22A-27.5</b>
	1-3/32	1.0938	27.78	3/16	<b>1C22T-0103</b>	<b>1C22A-0103</b>
	–	1.1024	28.00	3/16	<b>1C22T-28</b>	<b>1C22A-28</b>
	1-7/64	1.1094	28.18	3/16	<b>1C22T-1.109</b>	<b>1C22A-1.109</b>
	–	1.1220	28.50	3/16	<b>1C22T-28.5</b>	<b>1C22A-28.5</b>
	1-1/8	1.1250	28.58	3/16	<b>1C22T-0104</b>	<b>1C22A-0104</b>
	–	1.1417	29.00	3/16	<b>1C22T-29</b>	<b>1C22A-29</b>
1-5/32	1.1563	29.37	3/16	<b>1C22T-0105</b>	<b>1C22A-0105</b>	
–	1.1614	29.50	3/16	<b>1C22T-29.5</b>	<b>1C22A-29.5</b>	
–	1.1811	30.00	3/16	<b>1C22T-30</b>	<b>1C22A-30</b>	
2.5	1-3/16	1.1875	30.16	3/16	<b>1C22T-0106</b>	<b>1C22A-0106</b>
	–	1.2008	30.50	3/16	<b>1C22T-30.5</b>	<b>1C22A-30.5</b>
	1-7/32	1.2188	30.96	3/16	<b>1C22T-0107</b>	<b>1C22A-0107</b>
	–	1.2205	31.00	3/16	<b>1C22T-31</b>	<b>1C22A-31</b>
	–	1.2260	31.14	3/16	<b>1C22T-1.226</b>	<b>1C22A-1.226</b>
	–	1.2310	31.26	3/16	<b>1C22T-1.231</b>	<b>1C22A-1.231</b>
	–	1.2340	31.34	3/16	<b>1C22T-1.234</b>	<b>1C22A-1.234</b>
	–	1.2402	31.50	3/16	<b>1C22T-31.5</b>	<b>1C22A-31.5</b>
	1-1/4	1.2500	31.75	3/16	<b>1C22T-0108</b>	<b>1C22A-0108</b>
	–	1.2598	32.00	3/16	<b>1C22T-32</b>	<b>1C22A-32</b>
	–	1.2795	32.50	3/16	<b>1C22T-32.5</b>	<b>1C22A-32.5</b>
	1-9/32	1.2813	32.54	3/16	<b>1C22T-0109</b>	<b>1C22A-0109</b>
	–	1.2992	33.00	3/16	<b>1C22T-33</b>	<b>1C22A-33</b>
	1-5/16	1.3125	33.34	3/16	<b>1C22T-0110</b>	<b>1C22A-0110</b>
	–	1.3189	33.50	3/16	<b>1C22T-33.5</b>	<b>1C22A-33.5</b>
	–	1.3386	34.00	3/16	<b>1C22T-34</b>	<b>1C22A-34</b>
	1-11/32	1.3438	34.13	3/16	<b>1C22T-0111</b>	<b>1C22A-0111</b>
	–	1.3582	34.50	3/16	<b>1C22T-34.5</b>	<b>1C22A-34.5</b>
	1-3/8	1.3750	34.93	3/16	<b>1C22T-0112</b>	<b>1C22A-0112</b>
	–	1.3780	35.00	3/16	<b>1C22T-35</b>	<b>1C22A-35</b>

**NOTE:** 2.5 series inserts fit into both 2 and 2.5 series holders. However, 2 series inserts ONLY fit into 2 series holders. See page A30: 7 for visual.

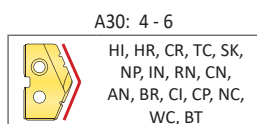
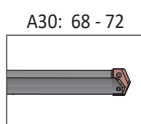
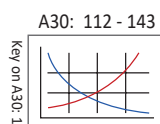

Coatings not listed above can be supplied as non-stocked standards. Process fees apply. →

Inserts sold in quantities of 1

TiN = 1C22T-XXXX	TiAlN = 1C22A-XXXX
TiCN = 1C22N-XXXX	AM200® = 1C22H-XXXX

A  
DRILLING  
B  
BORING  
C  
REAMING  
D  
BURNISHING  
E  
THREADING  
X  
SPECIALS

## T-A® Drill Inserts

2 Series | Carbide | Diameter Range: 0.961" - 1.380" (24.41 mm - 35.05 mm)



Flat Bottom

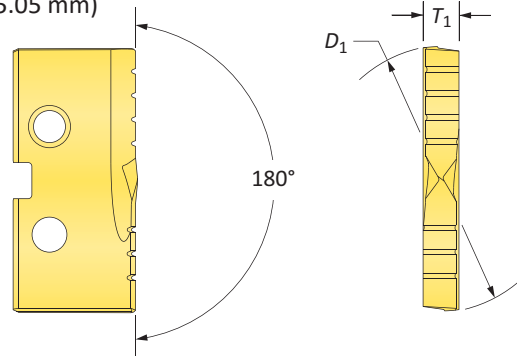

### Carbide Inserts – C2 (K20)

Series	Fractional Equivalent	Insert			Flat Bottom Part No.
		$D_1$ inch	$D_1$ mm	$T_1$	TiN 
2	–	0.9646	24.50	3/16	1C22T-24.5-FB
	31/32	0.9688	24.61	3/16	1C22T-0031-FB
	–	0.9760	24.79	3/16	1C22T-.976-FB
	63/64	0.9843	25.00	3/16	1C22T-25-FB
	1	1.0000	25.40	3/16	1C22T-0100-FB
	–	1.0039	25.50	3/16	1C22T-25.5-FB
	1-1/64	1.0156	25.80	3/16	1C22T-1.015-FB
	–	1.0236	26.00	3/16	1C22T-26-FB
	1-1/32	1.0313	26.19	3/16	1C22T-0101-FB
	–	1.0433	26.50	3/16	1C22T-26.5-FB
	1-3/64	1.0469	26.59	3/16	1C22T-1.046-FB
	1-1/16	1.0625	26.99	3/16	1C22T-0102-FB
	–	1.0630	27.00	3/16	1C22T-27-FB
	–	1.0827	27.50	3/16	1C22T-27.5-FB
	1-3/32	1.0938	27.78	3/16	1C22T-0103-FB
	–	1.1024	28.00	3/16	1C22T-28-FB
	1-7/64	1.1094	28.18	3/16	1C22T-1.109-FB
	–	1.1220	28.50	3/16	1C22T-28.5-FB
	1-1/8	1.1250	28.58	3/16	1C22T-0104-FB
	–	1.1417	29.00	3/16	1C22T-29-FB
1-5/32	1.1563	29.37	3/16	1C22T-0105-FB	
–	1.1614	29.50	3/16	1C22T-29.5-FB	
–	1.1811	30.00	3/16	1C22T-30-FB	
1-3/16	1.1875	30.16	3/16	1C22T-0106-FB	
–	1.2008	30.50	3/16	1C22T-30.5-FB	
1-7/32	1.2188	30.96	3/16	1C22T-0107-FB	
–	1.2205	31.00	3/16	1C22T-31-FB	
–	1.2260	31.14	3/16	1C22T-1.226-FB	
–	1.2310	31.26	3/16	1C22T-1.231-FB	
–	1.2340	31.34	3/16	1C22T-1.234-FB	
–	1.2402	31.50	3/16	1C22T-31.5-FB	
1-1/4	1.2500	31.75	3/16	1C22T-0108-FB	
–	1.2598	32.00	3/16	1C22T-32-FB	
–	1.2795	32.50	3/16	1C22T-32.5-FB	
1-9/32	1.2813	32.54	3/16	1C22T-0109-FB	
–	1.2992	33.00	3/16	1C22T-33-FB	
1-5/16	1.3125	33.34	3/16	1C22T-0110-FB	
–	1.3189	33.50	3/16	1C22T-33.5-FB	
–	1.3386	34.00	3/16	1C22T-34-FB	
1-11/32	1.3438	34.13	3/16	1C22T-0111-FB	
–	1.3582	34.50	3/16	1C22T-34.5-FB	
1-3/8	1.3750	34.93	3/16	1C22T-0112-FB	
–	1.3780	35.00	3/16	1C22T-35-FB	

**NOTE:** 2.5 series inserts fit into both 2 and 2.5 series holders. However, 2 series inserts ONLY fit into 2 series holders. See page A30: 7 for visual.

A30: 112 - 143

A30: 68 - 72

A30: 4 - 6

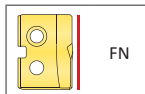
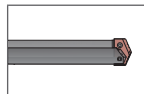
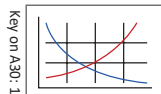

Coatings not listed above can be supplied as non-stocked standards. Process fees apply. →

TiN = 1C22T-XXXX	TiAlN = 1C22A-XXXX
TiCN = 1C22N-XXXX	AM200® = 1C22H-XXXX



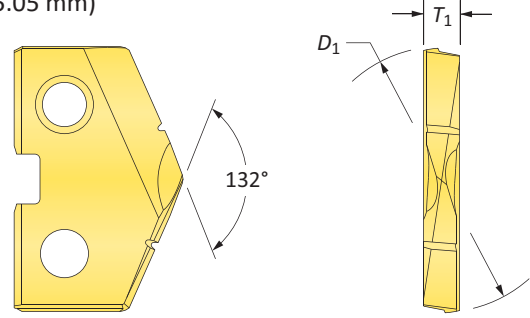

Inserts sold in quantities of 1

**T-A® Drill Inserts**

2 Series | Carbide | Diameter Range: 0.961" - 1.380" (24.41 mm - 35.05 mm)



Carbide Inserts – C5 (P40) | C3 (K10) | N2

Series	Insert				C5 Part No.		C3 Part No.	N2 Part No.
	Fractional Equivalent	D <sub>1</sub> inch	D <sub>1</sub> mm	T <sub>1</sub>	 TIN	 TiAlN	 TiAlN (Cast Iron)	 Diamond Film*
2	-	0.9646	24.50	3/16	1C52T-24.5	1C52A-24.5	1C32A-24.5-CI	1N22D-24.5
	31/32	0.9688	24.61	3/16	1C52T-0031	1C52A-0031	1C32A-0031-CI	1N22D-0031
	-	0.9760	24.79	3/16	1C52T-.976	1C52A-.976	1C32A-.976-CI	1N22D-.976
	63/64	0.9843	25.00	3/16	1C52T-25	1C52A-25	1C32A-25-CI	1N22D-25
	1	1.0000	25.40	3/16	1C52T-0100	1C52A-0100	1C32A-0100-CI	1N22D-0100
	-	1.0039	25.50	3/16	1C52T-25.5	1C52A-25.5	1C32A-25.5-CI	1N22D-25.5
	1-1/64	1.0156	25.80	3/16	1C52T-1.015	1C52A-1.015	1C32A-1.015-CI	1N22D-1.015
	-	1.0236	26.00	3/16	1C52T-26	1C52A-26	1C32A-26-CI	1N22D-26
	1-1/32	1.0313	26.19	3/16	1C52T-0101	1C52A-0101	1C32A-0101-CI	1N22D-0101
	-	1.0433	26.50	3/16	1C52T-26.5	1C52A-26.5	1C32A-26.5-CI	1N22D-26.5
	1-3/64	1.0469	26.59	3/16	1C52T-1.046	1C52A-1.046	1C32A-1.046-CI	1N22D-1.046
	1-1/16	1.0625	26.99	3/16	1C52T-0102	1C52A-0102	1C32A-0102-CI	1N22D-0102
	-	1.0630	27.00	3/16	1C52T-27	1C52A-27	1C32A-27-CI	1N22D-27
	-	1.0827	27.50	3/16	1C52T-27.5	1C52A-27.5	1C32A-27.5-CI	1N22D-27.5
	1-3/32	1.0938	27.78	3/16	1C52T-0103	1C52A-0103	1C32A-0103-CI	1N22D-0103
	-	1.1024	28.00	3/16	1C52T-28	1C52A-28	1C32A-28-CI	1N22D-28
	1-7/64	1.1094	28.18	3/16	1C52T-1.109	1C52A-1.109	1C32A-1.109-CI	1N22D-1.109
	-	1.1220	28.50	3/16	1C52T-28.5	1C52A-28.5	1C32A-28.5-CI	1N22D-28.5
	1-1/8	1.1250	28.58	3/16	1C52T-0104	1C52A-0104	1C32A-0104-CI	1N22D-0104
	-	1.1417	29.00	3/16	1C52T-29	1C52A-29	1C32A-29-CI	1N22D-29
1-5/32	1.1563	29.37	3/16	1C52T-0105	1C52A-0105	1C32A-0105-CI	1N22D-0105	
-	1.1614	29.50	3/16	1C52T-29.5	1C52A-29.5	1C32A-29.5-CI	1N22D-29.5	
-	1.1811	30.00	3/16	1C52T-30	1C52A-30	1C32A-30-CI	1N22D-30	
1-3/16	1.1875	30.16	3/16	1C52T-0106	1C52A-0106	1C32A-0106-CI	1N22D-0106	
-	1.2008	30.50	3/16	1C52T-30.5	1C52A-30.5	1C32A-30.5-CI	1N22D-30.5	
1-7/32	1.2188	30.96	3/16	1C52T-0107	1C52A-0107	1C32A-0107-CI	1N22D-0107	
-	1.2205	31.00	3/16	1C52T-31	1C52A-31	1C32A-31-CI	1N22D-31	
-	1.2260	31.14	3/16	1C52T-1.226	1C52A-1.226	1C32A-1.226-CI	1N22D-1.226	
-	1.2310	31.26	3/16	1C52T-1.231	1C52A-1.231	1C32A-1.231-CI	1N22D-1.231	
-	1.2340	31.34	3/16	1C52T-1.234	1C52A-1.234	1C32A-1.234-CI	1N22D-1.234	
-	1.2402	31.50	3/16	1C52T-31.5	1C52A-31.5	1C32A-31.5-CI	1N22D-31.5	
1-1/4	1.2500	31.75	3/16	1C52T-0108	1C52A-0108	1C32A-0108-CI	1N22D-0108	
-	1.2598	32.00	3/16	1C52T-32	1C52A-32	1C32A-32-CI	1N22D-32	
-	1.2795	32.50	3/16	1C52T-32.5	1C52A-32.5	1C32A-32.5-CI	1N22D-32.5	
1-9/32	1.2813	32.54	3/16	1C52T-0109	1C52A-0109	1C32A-0109-CI	1N22D-0109	
-	1.2992	33.00	3/16	1C52T-33	1C52A-33	1C32A-33-CI	1N22D-33	
1-5/16	1.3125	33.34	3/16	1C52T-0110	1C52A-0110	1C32A-0110-CI	1N22D-0110	
-	1.3189	33.50	3/16	1C52T-33.5	1C52A-33.5	1C32A-33.5-CI	1N22D-33.5	
-	1.3386	34.00	3/16	1C52T-34	1C52A-34	1C32A-34-CI	1N22D-34	
1-11/32	1.3438	34.13	3/16	1C52T-0111	1C52A-0111	1C32A-0111-CI	1N22D-0111	
-	1.3582	34.50	3/16	1C52T-34.5	1C52A-34.5	1C32A-34.5-CI	1N22D-34.5	
1-3/8	1.3750	34.93	3/16	1C52T-0112	1C52A-0112	1C32A-0112-CI	1N22D-0112	
-	1.3780	35.00	3/16	1C52T-35	1C52A-35	1C32A-35-CI	1N22D-35	

**NOTE:** 2.5 series inserts fit into both 2 and 2.5 series holders. However, 2 series inserts ONLY fit into 2 series holders. See page A30: 7 for visual.

\*Diamond Film is only available in standard geometry. For additional geometries, please contact Application Engineering.

Inserts sold in quantities of 1

A30: 112 - 143

A30: 68 - 72

A30: 4 - 6

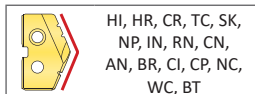
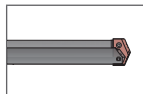
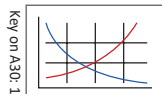

Coatings not listed above can be supplied as non-stocked standards. Process fees apply. →

TiN = 1C52T-XXXX	TiAlN = 1C52A-XXXX
TiCN = 1C52N-XXXX	AM200® = 1C52H-XXXX

## T-A® Drill Insert Holders

2 Series | Flange Shank | Diameter Range: 0.961" - 1.380" (24.41 mm - 35.05 mm)

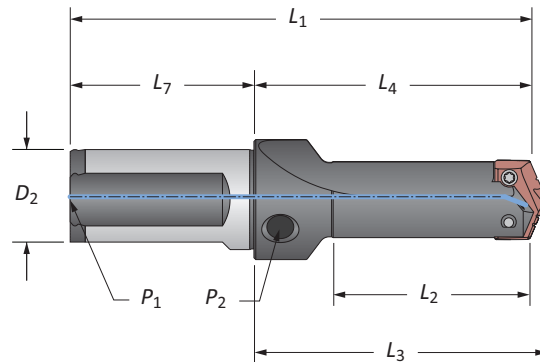
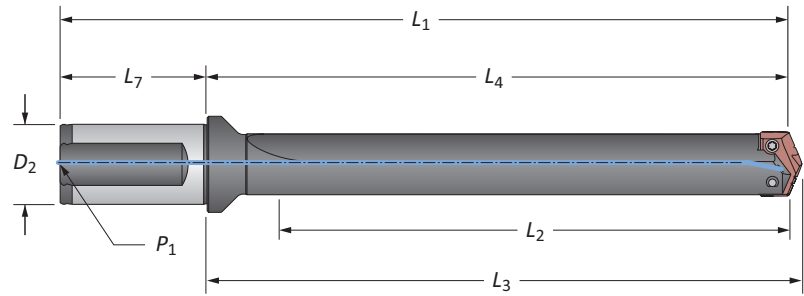

Stub Length

### Straight Flute

Series	Length	Body				Shank			Part No.
		L <sub>2</sub>	L <sub>4</sub>	L <sub>3</sub>	L <sub>1</sub>	D <sub>2</sub>	L <sub>7</sub>	P <sub>1</sub>	
2	Stub	2-1/4	3-31/64	3-5/8	5-49/64	1-1/4	2-9/32	1/4	21020S-125F
	Short	3-5/8	5-1/16	5-13/64	7-11/32	1-1/4	2-9/32	1/4	22020S-125F
	Intermediate	5-3/8	7-1/16	7-13/64	9-11/32	1-1/4	2-9/32	1/4	23020S-125F
	Standard	7-3/8	9-1/16	9-13/64	11-11/32	1-1/4	2-9/32	1/4	24020S-125F
	Extended	11-3/8	13-1/16	13-13/64	15-11/32	1-1/4	2-9/32	1/4	<b>25020S-125F</b>
2.5	Stub	3-3/8	4-55/64	5	7-9/64	1-1/4	2-9/32	1/4	21025S-125F
	Short	3-5/8	5-1/16	5-13/64	7-11/32	1-1/4	2-9/32	1/4	22025S-125F
	Intermediate	5-3/8	7-1/16	7-13/64	9-11/32	1-1/4	2-9/32	1/4	23025S-125F
	Standard	7-3/8	9-1/16	9-13/64	11-11/32	1-1/4	2-9/32	1/4	24025S-125F
	Extended	11-3/8	13-1/16	13-13/64	15-11/32	1-1/4	2-9/32	1/4	<b>25025S-125F</b>
2	Stub	57.2	88.5	92.1	148.5	32.0	60.0	1/4*	21020S-32FM
	Short	85.7	128.6	132.2	188.6	32.0	60.0	1/4*	22020S-32FM
	XL	511.0	554.1	557.7	614.1	32.0	60.0	1/4*	<b>27020S-32FM</b>
	3XL	692.0	735.1	738.7	795.1	32.0	60.0	1/4*	<b>29020S-32FM</b>
	2.5	Stub	85.7	123.4	127.0	183.4	32.0	60.0	1/4*
Short		85.7	128.6	132.2	188.6	32.0	60.0	1/4*	22025S-32FM

\*Metric thread to BSP and ISO 7-1

**NOTE:** Stub length holders have a 1/8" side pipe tap (P<sub>2</sub>)

### Connection Accessories

Insert Screws	Nylon Locking Screws	Insert Driver	Preset Torque Hand Driver	Replacement Tips	Admissible Tightening Torque*
7495-IP15-1	7495N-IP15-1	8IP-15	8IP-15TL	8IP-15B	61.0 in-lbs (690 N-cm)

\*Tightening torques are calculated with a friction coefficient of  $\mu = 0.14$  and develop 90% of ultimate yield strength

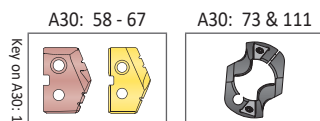

Key on A30: 1

**i** = Imperial (in)

**m** = Metric (mm)

Screws sold in quantities of 10

**WARNING** Refer to Speed and Feed charts for recommended adjustments to speeds and feeds. Refer to page A30: 146 for deep hole drilling guidelines in this section of the catalog. Visit [www.alliedmachine.com/DeepHoleGuidelines](http://www.alliedmachine.com/DeepHoleGuidelines) for the most up-to-date information and procedures. Factory technical assistance is available for your specific applications through our Application Engineering Team.

**T-A® Drill Insert Holders**

2 Series | Flange Shank | Diameter Range: 0.961" - 1.380" (24.41 mm - 35.05 mm)

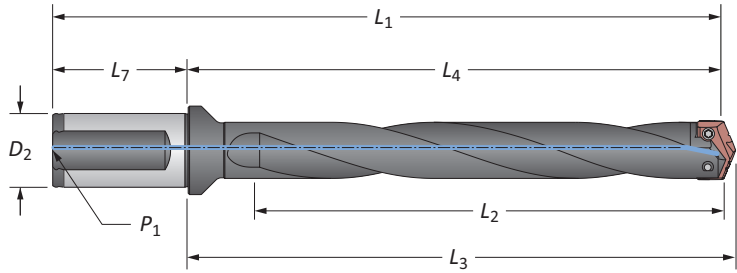





**Helical Flute**

Series	Length	Body				Shank			Part No.	
		L <sub>2</sub>	L <sub>4</sub>	L <sub>3</sub>	L <sub>1</sub>	D <sub>2</sub>	L <sub>7</sub>	P <sub>1</sub>		
i	2	Intermediate	5-3/8	7-1/16	7-13/64	9-11/32	1-1/4	2-9/32	1/4	23020H-125F
		Standard	7-3/8	9-1/16	9-13/64	11-11/32	1-1/4	2-9/32	1/4	24020H-125F
		Standard Plus	9-3/8	11-1/16	11-13/64	13-31/64	1-1/4	2-9/32	1/4	⚠ 24520H-125F
		Extended	11-3/8	13-1/16	13-13/64	15-11/32	1-1/4	2-9/32	1/4	⚠ 25020H-125F
		Long	16-1/8	17-53/64	7-31/32	20-1/4	1-1/4	2-9/32	1/4	⚠ 26020H-125F
2.5	2	Intermediate	5-3/8	7-1/16	7-13/64	9-11/32	1-1/4	2-9/32	1/4	23025H-125F
		Standard	7-3/8	9-1/16	9-13/64	11-11/32	1-1/4	2-9/32	1/4	24025H-125F
		Extended	11-3/8	13-1/16	13-13/64	15-11/32	1-1/4	2-9/32	1/4	⚠ 25025H-125F
ii	2	Intermediate	136.5	179.4	183.0	239.4	32.0	60.0	1/4*	23020H-32FM
		Standard	187.3	230.2	233.8	290.2	32.0	60.0	1/4*	24020H-32FM
		Standard Plus	238.0	280.9	284.5	340.9	32.0	60.0	1/4*	⚠ 24520H-32FM
		Extended	288.9	331.8	335.4	391.8	32.0	60.0	1/4*	⚠ 25020H-32FM
		Long	410.0	452.9	456.5	512.9	32.0	60.0	1/4*	⚠ 26020H-32FM
2.5	2	Intermediate	136.5	179.4	183.0	239.4	32.0	60.0	1/4*	23025H-32FM
		Standard	187.3	230.2	233.8	290.2	32.0	60.0	1/4*	24025H-32FM
		Extended	288.9	331.8	335.4	391.8	32.0	60.0	1/4*	⚠ 25025H-32FM

\*Metric thread to BSP and ISO 7-1

**Connection Accessories**

Insert Screws	Nylon Locking Screws	Insert Driver	Preset Torque Hand Driver	Replacement Tips	Admissible Tightening Torque*
 7495-IP15-1	 7495N-IP15-1	 8IP-15	 8IP-15TL	 8IP-15B	61.0 in-lbs (690 N-cm)

\*Tightening torques are calculated with a friction coefficient of  $\mu = 0.14$  and develop 90% of ultimate yield strength

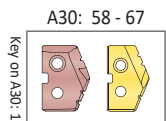

i = Imperial (in)  
m = Metric (mm)

Screws sold in quantities of 10

**⚠ WARNING** Refer to Speed and Feed charts for recommended adjustments to speeds and feeds. Refer to page A30: 146 for deep hole drilling guidelines in this section of the catalog. Visit [www.alliedmachine.com/DeepHoleGuidelines](http://www.alliedmachine.com/DeepHoleGuidelines) for the most up-to-date information and procedures. Factory technical assistance is available for your specific applications through our Application Engineering Team.

## T-A® Drill Insert Holders

2 Series | Taper Shank | Diameter Range: 0.961" - 1.380" (24.41 mm - 35.05 mm)

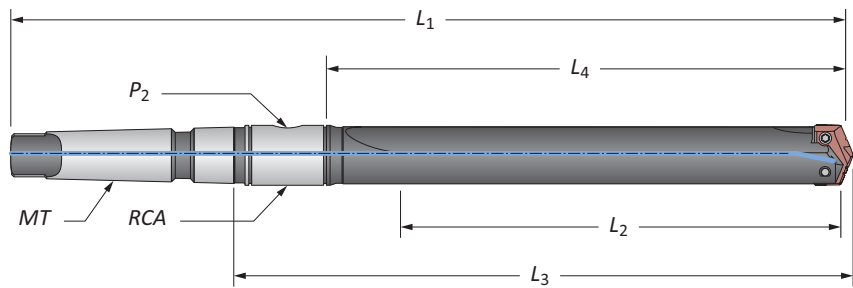

### Straight Flute

Series	Length	Body				Shank			Part No.	
		L <sub>2</sub>	L <sub>4</sub>	L <sub>3</sub>	L <sub>1</sub>	MT	P <sub>2</sub>	RCA		
2	Short	3-3/8	4-1/2	6-15/64	9-25/32	#3	1/8	2T-3SR	22020S-003I	
	Short	3-3/8	4-1/2	6-19/64	10-25/32	#4	1/8	2T-3SR	22020S-004I	
	Intermediate	5-3/8	6-1/2	8-19/64	12-25/32	#4	1/8	2T-3SR	23020S-004I	
	Standard	7-3/8	8-1/2	10-15/64	13-25/32	#3	1/8	2T-3SR	24020S-003I	
	Standard	7-3/8	8-1/2	10-19/64	14-25/32	#4	1/8	2T-3SR	24020S-004I	
2.5	Extended	11-3/8	12-1/2	14-15/64	18-25/32	#4	1/4	2T-3SR	25020S-004I	
	Short	3-3/8	4-1/2	6-15/64	9-25/32	#3	1/8	2T-3SR	22025S-003I	
	Short	3-3/8	4-1/2	6-37/64	11-1/16	#4	1/4	2T-4SR	22025S-004I	
	Intermediate	5-3/8	6-1/2	8-37/64	13-1/16	#4	1/4	2T-4SR	23025S-004I	
	Standard	7-3/8	8-1/2	10-15/64	13-25/32	#3	1/8	2T-3SR	24025S-003I	
	Standard	7-3/8	8-1/2	10-37/64	15-1/16	#4	1/8	2T-4SR	24025S-004I	
Metric (m)	2	Short	92.1	114.3	142.5	273.8	#4**	1/8*	2T-3SRM	22020S-004M
	2.5	Short	92.1	114.3	142.5	281.0	#4**	1/4*	2T-4SRM	22025S-004M

\*Metric thread to BSP and ISO 7-1

\*\*Per ISO 296 type BEK

**NOTE:** 2.5 series inserts fit into both 2 and 2.5 series holders. However, 2 series inserts ONLY fit into 2 series holders. See page A30: 7 for visual.

### Connection Accessories

Insert Screws	Nylon Locking Screws	Insert Driver	Preset Torque Hand Driver	Replacement Tips	Admissible Tightening Torque*
7495-IP15-1	7495N-IP15-1	8IP-15	8IP-15TL	8IP-15B	61.0 in-lbs (690 N-cm)

\*Tightening torques are calculated with a friction coefficient of  $\mu = 0.14$  and develop 90% of ultimate yield strength

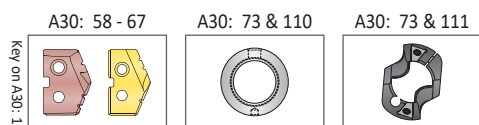

Key on A30: 1

i = Imperial (in)

m = Metric (mm)

Screws sold in quantities of 10

**WARNING** Refer to Speed and Feed charts for recommended adjustments to speeds and feeds. Refer to page A30: 146 for deep hole drilling guidelines in this section of the catalog. Visit [www.alliedmachine.com/DeepHoleGuidelines](http://www.alliedmachine.com/DeepHoleGuidelines) for the most up-to-date information and procedures. Factory technical assistance is available for your specific applications through our Application Engineering Team.

T-A® Drill Insert Holders

2 Series | Taper Shank | Diameter Range: 0.961" - 1.380" (24.41 mm - 35.05 mm)

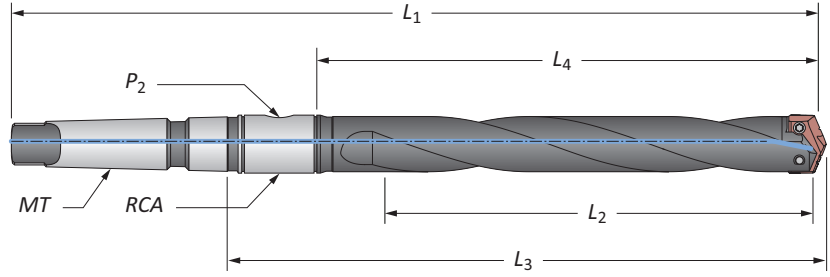

Helical Flute

Series	Length	Body				Shank			Part No.	
		L <sub>2</sub>	L <sub>4</sub>	L <sub>3</sub>	L <sub>1</sub>	MT	P <sub>2</sub>	RCA		
i	2	Intermediate	5-3/8	6-1/2	8-19/64	12-25/32	#4	1/8	2T-3SR	23020H-004I
		Standard	7-3/8	8-1/2	10-15/64	13-25/32	#3	1/8	2T-3SR	24020H-003I
		Standard	7-3/8	8-1/2	10-19/64	14-25/32	#4	1/8	2T-3SR	24020H-004I
		Extended	11-3/8	12-1/2	14-15/64	18-25/32	#4	1/8	2T-3SR	⚠ 25020H-004I
i	2.5	Intermediate	5-3/8	6-1/2	8-37/64	13-1/16	#4	1/4	2T-4SR	23025H-004I
		Standard	7-3/8	8-1/2	10-15/64	13-25/32	#3	1/8	2T-3SR	24025H-003I
		Standard	7-3/8	8-1/2	10-37/64	15-1/16	#4	1/4	2T-4SR	24025H-004I
		Extended	11-3/8	12-1/2	14-37/64	19-1/16	#4	1/4	2T-4SR	⚠ 25025H-004I
m	2	Intermediate	136.5	165.1	211.2	324.6	#4**	1/8*	2T-3SRM	23020H-004M
		Standard	187.3	215.9	262.0	375.4	#4**	1/8*	2T-3SRM	24020H-004M
		Extended	289.0	317.5	363.6	477.0	#4**	1/8*	2T-3SRM	⚠ 25020H-004M
	2.5	Intermediate	136.5	165.1	218.4	331.8	#4**	1/4*	2T-4SRM	23025H-004M
		Standard	187.3	215.9	269.2	382.6	#4**	1/4*	2T-4SRM	24025H-004M
		Extended	289.0	317.5	370.8	484.2	#4**	1/4*	2T-4SRM	⚠ 25025H-004M

\*Metric thread to BSP and ISO 7-1

\*\*Per ISO 296 type BEK

**NOTE:** 2.5 series inserts fit into both 2 and 2.5 series holders. However, 2 series inserts ONLY fit into 2 series holders. See page A30: 7 for visual.

Connection Accessories

Insert Screws	Nylon Locking Screws	Insert Driver	Preset Torque Hand Driver	Replacement Tips	Admissible Tightening Torque*
7495-IP15-1	7495N-IP15-1	8IP-15	8IP-15TL	8IP-15B	61.0 in-lbs (690 N-cm)

\*Tightening torques are calculated with a friction coefficient of  $\mu = 0.14$  and develop 90% of ultimate yield strength

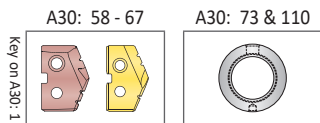

i = Imperial (in)  
m = Metric (mm)

Screws sold in quantities of 10

**⚠ WARNING** Refer to Speed and Feed charts for recommended adjustments to speeds and feeds. Refer to page A30: 146 for deep hole drilling guidelines in this section of the catalog. Visit [www.alliedmachine.com/DeepHoleGuidelines](http://www.alliedmachine.com/DeepHoleGuidelines) for the most up-to-date information and procedures. Factory technical assistance is available for your specific applications through our Application Engineering Team.

## T-A® Drill Insert Holders

2 Series | Straight Shank | Diameter Range: 0.961" - 1.380" (24.41 mm - 35.05 mm)

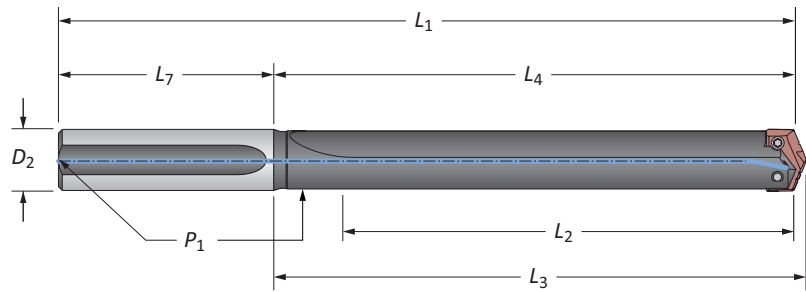

### Straight Flute

Series	Length	Body				Shank			Part No.
		L <sub>2</sub>	L <sub>4</sub>	L <sub>3</sub>	L <sub>1</sub>	D <sub>2</sub>	L <sub>7</sub>	P <sub>1</sub>	
2	Short	3-3/8	4-1/2	4-41/64	8	1	3-1/2	1/8	22020S-100L
	Short	3-3/8	4-1/2	4-41/64	8	1-1/4	3-1/2	1/8	22020S-125L
	Intermediate	5-3/8	6-1/2	6-41/64	10	1-1/4	3-1/2	1/8	23020S-125L
	Standard	7-3/8	8-1/2	8-41/64	12	1	3-1/2	1/8	24020S-100L
	Standard	7-3/8	8-1/2	8-41/64	12	1-1/4	3-1/2	1/8	24020S-125L
	Extended	11-3/8	12-1/2	12-41/64	16	1-1/4	3-1/2	1/8	25020S-125L
	XL	20-1/8	21-1/4	21-25/64	24-3/4	1-1/4	3-1/2	1/8	27020S-125L
2.5	3XL	27-1/4	28-3/8	28-33/64	31-7/8	1-1/4	3-1/2	1/8	29020S-125L
	Short	3-3/8	4-1/2	4-41/64	8	1	3-1/2	1/8*	22025S-100L
	Short	3-3/8	4-1/2	4-41/64	8	1-1/4	3-1/2	1/8*	22025S-125L
	Intermediate	5-3/8	6-1/2	6-41/64	10	1-1/4	3-1/2	1/8*	23025S-125L
	Standard	7-3/8	8-1/2	8-41/64	12	1	3-1/2	1/8*	24025S-100L
	Standard	7-3/8	8-1/2	8-41/64	12	1-1/4	3-1/2	1/8*	24025S-125L
	Extended	11-3/8	12-1/2	12-41/64	16	1-1/4	3-1/2	1/8*	25025S-125L

**NOTE:** 2.5 series inserts fit into both 2 and 2.5 series holders. However, 2 series inserts ONLY fit into 2 series holders. See page A30: 7 for visual.

### Connection Accessories

Insert Screws	Nylon Locking Screws	Insert Driver	Preset Torque Hand Driver	Replacement Tips	Admissible Tightening Torque*
7495-IP15-1	7495N-IP15-1	8IP-15	8IP-15TL	8IP-15B	61.0 in-lbs (690 N-cm)

\*Tightening torques are calculated with a friction coefficient of  $\mu = 0.14$  and develop 90% of ultimate yield strength

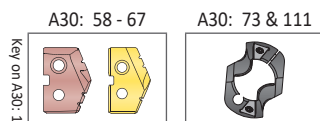

i = Imperial (in)  
m = Metric (mm)

Screws sold in quantities of 10

**WARNING** Refer to Speed and Feed charts for recommended adjustments to speeds and feeds. Refer to page A30: 146 for deep hole drilling guidelines in this section of the catalog. Visit [www.alliedmachine.com/DeepHoleGuidelines](http://www.alliedmachine.com/DeepHoleGuidelines) for the most up-to-date information and procedures. Factory technical assistance is available for your specific applications through our Application Engineering Team.



T-A® Drill Accessories

2 Series | Chamfer Rings | Rotary Coolant Adapters | Torx® Plus Screws

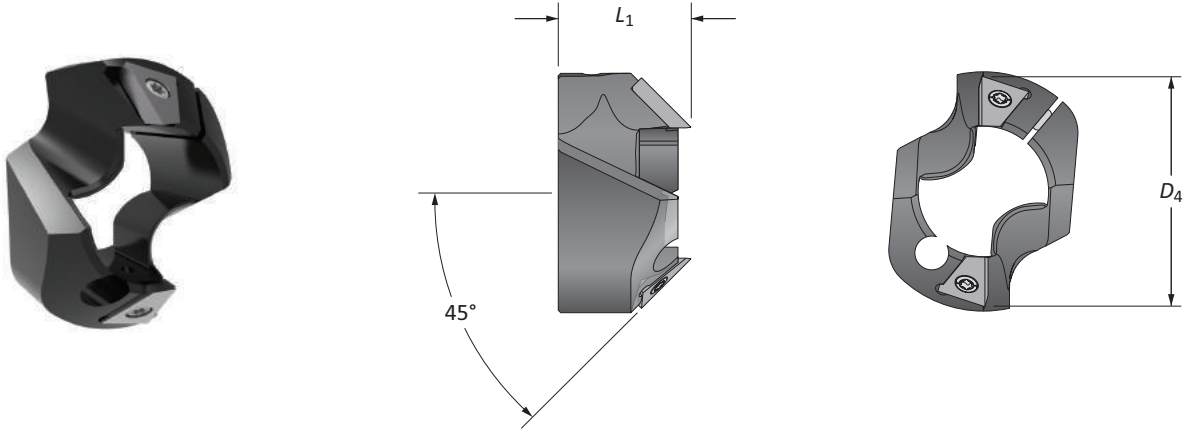

T-ACR 45 Chamfer Ring

Holder Series	D <sub>1</sub> Range	Chamfer Ring		Part No.	Insert Part No.	Insert Screw	Insert Driver	Clamping Screw	Insert Driver
		D <sub>4</sub>	L <sub>1</sub>						
2	0.9610 - 1.3800	1-9/16	1	T-ACR-45-2	T-ACRI-45-B-C5A	7255-IP8-1	8IP-8	7514-IP20-1	8IP-20

Rotary Coolant Adapter (RCA) and Accessories

ID	OD	L <sub>1</sub>	Driving Rod Thread	P <sub>1</sub>	Part No.	RCA O-Rings		
						Kit Part No.**	Replacements	
i	1	2-1/8	1-1/8	5/16-18	1/8	▲ 2T-3SR	2T1-3SR	2T1-3OR-10
	1-1/4	2-1/2	1-3/8	3/8-16	1/4	▲ 2T-4SR	2T1-4SR	2T1-4OR-10
m	25.40	53.97	28.57	M8 x 1.25	1/8*	▲ 2T-3SRM	2T1-3SR	2T1-3OR-10
	31.75	63.50	34.92	M10 x 1.50	1/4*	▲ 2T-4SRM	2T1-4SR	2T1-4OR-10

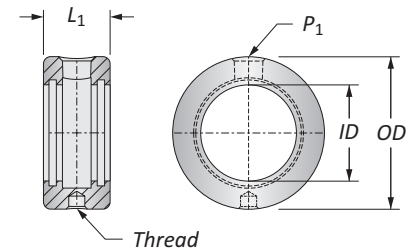

\*Thread to BSP and ISO 7-1

\*\*RCA Repair Kit includes (2) O-rings, (2) snap rings, and (2) thrust washers

▲ Refer to page A30: 110 for proper RCA assembly and safety information

Connection Accessories

Insert Screws	Nylon Locking Screws	Insert Driver	Preset Torque Hand Driver	Replacement Tips	Admissible Tightening Torque*
7495-IP15-1	7495N-IP15-1	8IP-15	8IP-15TL	8IP-15B	61.0 in-lbs (690 N-cm)

\*Tightening torques are calculated with a friction coefficient of  $\mu = 0.14$  and develop 90% of ultimate yield strength

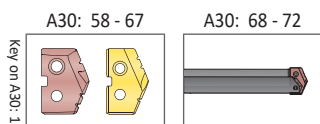

Key on A30: 1

i = Imperial (in)  
m = Metric (mm)

Inserts sold separately  
Screws sold in packs of 10  
O-rings sold in packs of 10

**WARNING** RCA rotation during drilling can cause hose and/or hose fitting failure, machinery damage, and/or serious injury. To prevent, use RCA and positive stop studs when drilling. Factory technical assistance is also available for your specific applications.



A DRILLING  
B BORING  
C REAMING  
D BURNISHING  
E THREADING  
X SPECIALS

## GEN2 T-A® Drill Inserts

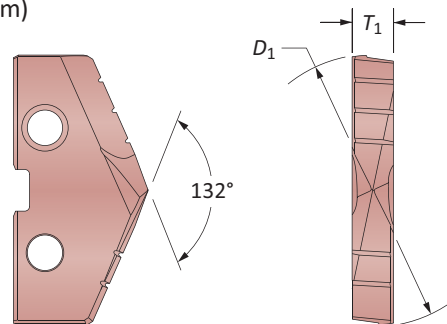
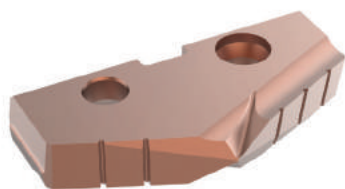
3 Series | HSS | Diameter Range: 1.353" - 1.882" (34.36 mm - 47.80 mm)

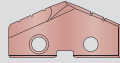

### HSS Inserts – Premium Cobalt

Fractional Equivalent	Insert			Part No.	
	$D_1$ inch	$D_1$ mm	$T_1$	 AM200®	 TiN
1-13/32	1.4063	35.72	1/4	483H-0113	483T-0113
-	1.4173	36.00	1/4	483H-36	483T-36
1-7/16	1.4375	36.51	1/4	483H-0114	483T-0114
-	1.4567	37.00	1/4	483H-37	483T-37
1-15/32	1.4688	37.31	1/4	483H-0115	483T-0115
-	1.4961	38.00	1/4	483H-38	483T-38
1-1/2	1.5000	38.10	1/4	483H-0116	483T-0116
1-17/32	1.5313	38.89	1/4	483H-0117	483T-0117
-	1.5354	39.00	1/4	483H-39	483T-39
-	1.5470	39.29	1/4	483H-1.547	483T-1.547
1-9/16	1.5625	39.69	1/4	483H-0118	483T-0118
-	1.5748	40.00	1/4	483H-40	483T-40
1-19/32	1.5938	40.48	1/4	483H-0119	483T-0119
-	1.6142	41.00	1/4	483H-41	483T-41
1-5/8	1.6250	41.28	1/4	483H-0120	483T-0120
-	1.6535	42.00	1/4	483H-42	483T-42
1-21/32	1.6563	42.07	1/4	483H-0121	483T-0121
1-11/16	1.6875	42.86	1/4	483H-0122	483T-0122
-	1.6929	43.00	1/4	483H-43	483T-43
1-23/32	1.7188	43.66	1/4	483H-0123	483T-0123
-	1.7323	44.00	1/4	483H-44	483T-44
1-3/4	1.7500	44.45	1/4	483H-0124	483T-0124
-	1.7717	45.00	1/4	483H-45	483T-45
1-25/32	1.7813	45.24	1/4	483H-0125	483T-0125
-	1.7913	45.50	1/4	483H-45.5	483T-45.5
-	1.7970	45.64	1/4	483H-1.797	483T-1.797
-	1.8110	46.00	1/4	483H-46	483T-46
1-13/16	1.8125	46.04	1/4	483H-0126	483T-0126
1-27/32	1.8438	46.83	1/4	483H-0127	483T-0127
-	1.8504	47.00	1/4	483H-47	483T-47
1-7/8	1.8750	47.63	1/4	483H-0128	483T-0128

A30: 112 - 143

A30: 82 - 85

A30: 4 - 6

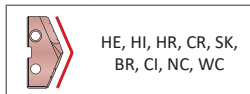
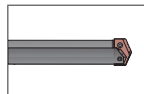
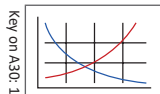

Coatings not listed above can be supplied as non-stocked standards. Process fees apply. →

TiN = 483T-XXXX

TiAlN = 483A-XXXX

TiCN = 483N-XXXX

AM200® = 483H-XXXX

Inserts sold in quantities of 1

### GEN2 T-A® Drill Inserts

3 Series | HSS | Diameter Range: 1.353" - 1.882" (34.36 mm - 47.80 mm)

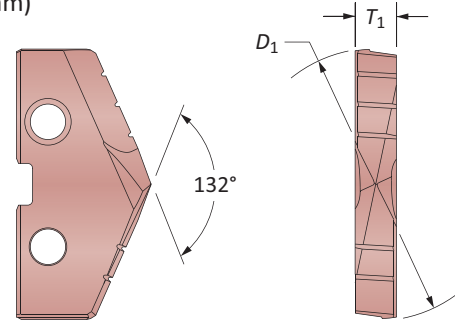

#### HSS Inserts – Super Cobalt

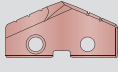
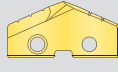
Fractional Equivalent	Insert			Part No.	
	$D_1$ inch	$D_1$ mm	$T_1$	 AM200®	 TiN
1-13/32	1.4063	35.72	1/4	453H-0113	453T-0113
-	1.4173	36.00	1/4	453H-36	453T-36
1-7/16	1.4375	36.51	1/4	453H-0114	453T-0114
-	1.4567	37.00	1/4	453H-37	453T-37
1-15/32	1.4688	37.31	1/4	453H-0115	453T-0115
-	1.4961	38.00	1/4	453H-38	453T-38
1-1/2	1.5000	38.10	1/4	453H-0116	453T-0116
1-17/32	1.5313	38.89	1/4	453H-0117	453T-0117
-	1.5354	39.00	1/4	453H-39	453T-39
-	1.5470	39.29	1/4	453H-1.547	453T-1.547
1-9/16	1.5625	39.69	1/4	453H-0118	453T-0118
-	1.5748	40.00	1/4	453H-40	453T-40
1-19/32	1.5938	40.48	1/4	453H-0119	453T-0119
-	1.6142	41.00	1/4	453H-41	453T-41
1-5/8	1.6250	41.28	1/4	453H-0120	453T-0120
-	1.6535	42.00	1/4	453H-42	453T-42
1-21/32	1.6563	42.07	1/4	453H-0121	453T-0121
1-11/16	1.6875	42.86	1/4	453H-0122	453T-0122
-	1.6929	43.00	1/4	453H-43	453T-43
1-23/32	1.7188	43.66	1/4	453H-0123	453T-0123
-	1.7323	44.00	1/4	453H-44	453T-44
1-3/4	1.7500	44.45	1/4	453H-0124	453T-0124
-	1.7717	45.00	1/4	453H-45	453T-45
1-25/32	1.7813	45.24	1/4	453H-0125	453T-0125
-	1.7913	45.50	1/4	453H-45.5	453T-45.5
-	1.7970	45.64	1/4	453H-1.797	453T-1.797
-	1.8110	46.00	1/4	453H-46	453T-46
1-13/16	1.8125	46.04	1/4	453H-0126	453T-0126
1-27/32	1.8438	46.83	1/4	453H-0127	453T-0127
-	1.8504	47.00	1/4	453H-47	453T-47
1-7/8	1.8750	47.63	1/4	453H-0128	453T-0128

A30: 112 - 143

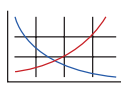

Key on A30-1

A30: 82 - 85

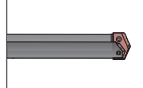

A30: 4 - 6



HE, HI, HR, CR, SK,  
BR, CI, NC, WC

Coatings not listed above can be supplied as non-stocked standards. Process fees apply. →

TiN = 453T-XXXX	TiAlN = 453A-XXXX
TiCN = 453N-XXXX	AM200® = 453H-XXXX

Inserts sold in quantities of 1

## GEN2 T-A® Drill Inserts

3 Series | HSS | Diameter Range: 1.353" - 1.882" (34.36 mm - 47.80 mm)

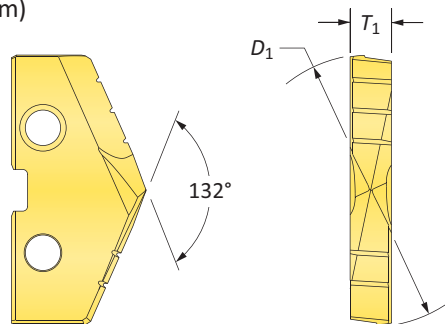

### HSS Inserts – HSS

Fractional Equivalent	Insert			Part No.
	$D_1$ inch	$D_1$ mm	$T_1$	
1-13/32	1.4063	35.72	1/4	 433T-0113
-	1.4173	36.00	1/4	433T-36
1-7/16	1.4375	36.51	1/4	433T-0114
-	1.4567	37.00	1/4	433T-37
1-15/32	1.4688	37.31	1/4	433T-0115
-	1.4961	38.00	1/4	433T-38
1-1/2	1.5000	38.10	1/4	433T-0116
1-17/32	1.5313	38.89	1/4	433T-0117
-	1.5354	39.00	1/4	433T-39
-	1.5470	39.29	1/4	433T-1.547
1-9/16	1.5625	39.69	1/4	433T-0118
-	1.5748	40.00	1/4	433T-40
1-19/32	1.5938	40.48	1/4	433T-0119
-	1.6142	41.00	1/4	433T-41
1-5/8	1.6250	41.28	1/4	433T-0120
-	1.6535	42.00	1/4	433T-42
1-21/32	1.6563	42.07	1/4	433T-0121
1-11/16	1.6875	42.86	1/4	433T-0122
-	1.6929	43.00	1/4	433T-43
1-23/32	1.7188	43.66	1/4	433T-0123
-	1.7323	44.00	1/4	433T-44
1-3/4	1.7500	44.45	1/4	433T-0124
-	1.7717	45.00	1/4	433T-45
1-25/32	1.7813	45.24	1/4	433T-0125
-	1.7913	45.50	1/4	433T-45.5
-	1.7970	45.64	1/4	433T-1.797
-	1.8110	46.00	1/4	433T-46
1-13/16	1.8125	46.04	1/4	433T-0126
1-27/32	1.8438	46.83	1/4	433T-0127
-	1.8504	47.00	1/4	433T-47
1-7/8	1.8750	47.63	1/4	433T-0128

Inserts sold in quantities of 1

A30: 112 - 143

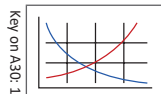

A30: 82 - 85

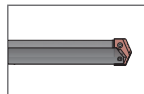

A30: 4 - 6

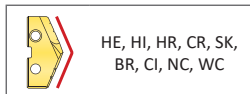

Coatings not listed above  
can be supplied as  
non-stocked standards.  
Process fees apply. →

TiN = 433T-XXXX

TiAlN = 433A-XXXX

TiCN = 433N-XXXX

AM200® = 433H-XXXX

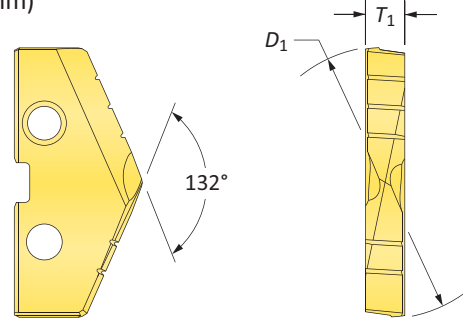

**T-A® Drill Inserts**

3 Series | HSS | Diameter Range: 1.353" - 1.882" (34.36 mm - 47.80 mm)

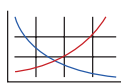

**HSS Inserts – Super Cobalt**

Fractional Equivalent	Insert			Part No.
	D <sub>1</sub> inch	D <sub>1</sub> mm	T <sub>1</sub>	
1-13/32	1.4063	35.72	1/4	153T-0113
-	1.4173	36.00	1/4	153T-36
1-7/16	1.4375	36.51	1/4	153T-0114
-	1.4567	37.00	1/4	153T-37
1-15/32	1.4688	37.31	1/4	153T-0115
-	1.4961	38.00	1/4	153T-38
1-1/2	1.5000	38.10	1/4	153T-0116
1-17/32	1.5313	38.89	1/4	153T-0117
-	1.5354	39.00	1/4	153T-39
-	1.5470	39.29	1/4	153T-1.547
1-9/16	1.5625	39.69	1/4	153T-0118
-	1.5748	40.00	1/4	153T-40
1-19/32	1.5938	40.48	1/4	153T-0119
-	1.6142	41.00	1/4	153T-41
1-5/8	1.6250	41.28	1/4	153T-0120
-	1.6535	42.00	1/4	153T-42
1-21/32	1.6563	42.07	1/4	153T-0121
1-11/16	1.6875	42.86	1/4	153T-0122
-	1.6929	43.00	1/4	153T-43
1-23/32	1.7188	43.66	1/4	153T-0123
-	1.7323	44.00	1/4	153T-44
1-3/4	1.7500	44.45	1/4	153T-0124
-	1.7717	45.00	1/4	153T-45
1-25/32	1.7813	45.24	1/4	153T-0125
-	1.7913	45.50	1/4	153T-45.5
-	1.7970	45.64	1/4	153T-1.797
-	1.8110	46.00	1/4	153T-46
1-13/16	1.8125	46.04	1/4	153T-0126
1-27/32	1.8438	46.83	1/4	153T-0127
-	1.8504	47.00	1/4	153T-47
1-7/8	1.8750	47.63	1/4	153T-0128

A30: 112 - 143  A30: 82 - 85  A30: 4 - 6 

HI, HR, CR, SK, BR, CI, NC, WC, TC, CN, IN, NP, RN

Coatings not listed above can be supplied as non-stocked standards. Process fees apply. →

Inserts sold in quantities of 1

TiN = 153T-XXXX	TiAlN = 153A-XXXX
TiCN = 153N-XXXX	AM200® = 153H-XXXX

## T-A® Drill Inserts

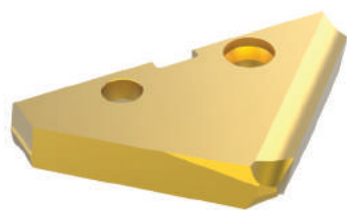

3 Series | HSS | Diameter Range: 1.353" - 1.882" (34.36 mm - 47.80 mm)

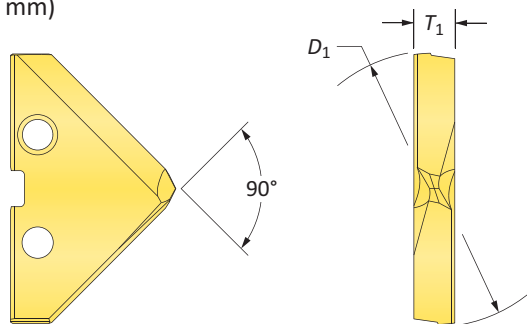

90° Spot & Chamfer



### HSS Inserts – Super Cobalt

Fractional Equivalent	Insert			Part No.		
	$D_1$ inch	$D_1$ mm	$T_1$	 TiN	 TiAlN	 TiCN
1-13/32	1.4063	35.72	1/4	153T-0113-SP	153A-0113-SP	153N-0113-SP
-	1.4173	36.00	1/4	153T-36-SP	153A-36-SP	153N-36-SP
1-7/16	1.4375	36.51	1/4	153T-0114-SP	153A-0114-SP	153N-0114-SP
-	1.4567	37.00	1/4	153T-37-SP	153A-37-SP	153N-37-SP
1-15/32	1.4688	37.31	1/4	153T-0115-SP	153A-0115-SP	153N-0115-SP
-	1.4961	38.00	1/4	153T-38-SP	153A-38-SP	153N-38-SP
1-1/2	1.5000	38.10	1/4	153T-0116-SP	153A-0116-SP	153N-0116-SP
1-17/32	1.5313	38.89	1/4	153T-0117-SP	153A-0117-SP	153N-0117-SP
-	1.5354	39.00	1/4	153T-39-SP	153A-39-SP	153N-39-SP
-	1.5470	39.29	1/4	153T-1.547-SP	153A-1.547-SP	153N-1.547-SP
1-9/16	1.5625	39.69	1/4	153T-0118-SP	153A-0118-SP	153N-0118-SP
-	1.5748	40.00	1/4	153T-40-SP	153A-40-SP	153N-40-SP
1-19/32	1.5938	40.48	1/4	153T-0119-SP	153A-0119-SP	153N-0119-SP
-	1.6142	41.00	1/4	153T-41-SP	153A-41-SP	153N-41-SP
1-5/8	1.6250	41.28	1/4	153T-0120-SP	153A-0120-SP	153N-0120-SP
-	1.6535	42.00	1/4	153T-42-SP	153A-42-SP	153N-42-SP
1-21/32	1.6563	42.07	1/4	153T-0121-SP	153A-0121-SP	153N-0121-SP
1-11/16	1.6875	42.86	1/4	153T-0122-SP	153A-0122-SP	153N-0122-SP
-	1.6929	43.00	1/4	153T-43-SP	153A-43-SP	153N-43-SP
1-23/32	1.7188	43.66	1/4	153T-0123-SP	153A-0123-SP	153N-0123-SP
-	1.7323	44.00	1/4	153T-44-SP	153A-44-SP	153N-44-SP
1-3/4	1.7500	44.45	1/4	153T-0124-SP	153A-0124-SP	153N-0124-SP
-	1.7717	45.00	1/4	153T-45-SP	153A-45-SP	153N-45-SP
1-25/32	1.7813	45.24	1/4	153T-0125-SP	153A-0125-SP	153N-0125-SP
-	1.7913	45.50	1/4	153T-45.5-SP	153A-45.5-SP	153N-45.5-SP
-	1.7970	45.64	1/4	153T-1.797-SP	153A-1.797-SP	153N-1.797-SP
-	1.8110	46.00	1/4	153T-46-SP	153A-46-SP	153N-46-SP
1-13/16	1.8125	46.04	1/4	153T-0126-SP	153A-0126-SP	153N-0126-SP
1-27/32	1.8438	46.83	1/4	153T-0127-SP	153A-0127-SP	153N-0127-SP
-	1.8504	47.00	1/4	153T-47-SP	153A-47-SP	153N-47-SP
1-7/8	1.8750	47.63	1/4	153T-0128-SP	153A-0128-SP	153N-0128-SP

A30: 112 - 143

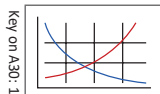

A30: 82 - 85

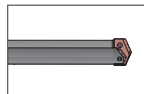

A30: 4 - 6



Coatings not listed above can be supplied as non-stocked standards. Process fees apply. →

TiN = 153T-XXXX

TiAlN = 153A-XXXX

TiCN = 153N-XXXX

AM200® = 153H-XXXX

Inserts sold in quantities of 1

T-A® Drill Inserts

3 Series | HSS | Diameter Range: 1.353" - 1.882" (34.36 mm - 47.80 mm)

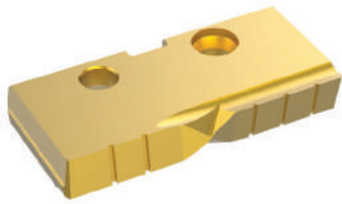

Flat Bottom

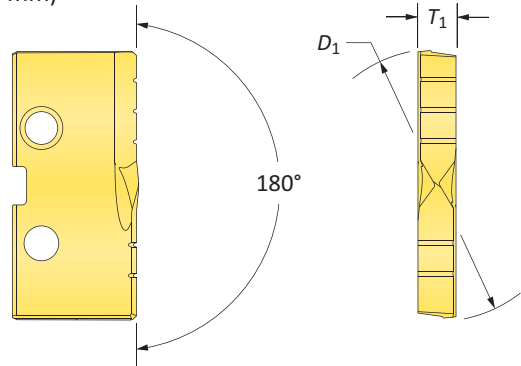

HSS Inserts – Super Cobalt

Fractional Equivalent	Insert			Part No.
	D <sub>1</sub> inch	D <sub>1</sub> mm	T <sub>1</sub>	
1-13/32	1.4063	35.72	1/4	153T-0113-FB
-	1.4173	36.00	1/4	153T-36-FB
1-7/16	1.4375	36.51	1/4	153T-0114-FB
-	1.4567	37.00	1/4	153T-37-FB
1-15/32	1.4688	37.31	1/4	153T-0115-FB
-	1.4961	38.00	1/4	153T-38-FB
1-1/2	1.5000	38.10	1/4	153T-0116-FB
1-17/32	1.5313	38.89	1/4	153T-0117-FB
-	1.5354	39.00	1/4	153T-39-FB
-	1.5470	39.29	1/4	153T-1.547-FB
1-9/16	1.5625	39.69	1/4	153T-0118-FB
-	1.5748	40.00	1/4	153T-40-FB
1-19/32	1.5938	40.48	1/4	153T-0119-FB
-	1.6142	41.00	1/4	153T-41-FB
1-5/8	1.6250	41.28	1/4	153T-0120-FB
-	1.6535	42.00	1/4	153T-42-FB
1-21/32	1.6563	42.07	1/4	153T-0121-FB
1-11/16	1.6875	42.86	1/4	153T-0122-FB
-	1.6929	43.00	1/4	153T-43-FB
1-23/32	1.7188	43.66	1/4	153T-0123-FB
-	1.7323	44.00	1/4	153T-44-FB
1-3/4	1.7500	44.45	1/4	153T-0124-FB
-	1.7717	45.00	1/4	153T-45-FB
1-25/32	1.7813	45.24	1/4	153T-0125-FB
-	1.7913	45.50	1/4	153T-45.5-FB
-	1.7970	45.64	1/4	153T-1.797-FB
-	1.8110	46.00	1/4	153T-46-FB
1-13/16	1.8125	46.04	1/4	153T-0126-FB
1-27/32	1.8438	46.83	1/4	153T-0127-FB
-	1.8504	47.00	1/4	153T-47-FB
1-7/8	1.8750	47.63	1/4	153T-0128-FB

Key on A30-1

A30: 112 - 143

A30: 82 - 85

A30: 4 - 6

Coatings not listed above can be supplied as non-stocked standards. Process fees apply. →

TiN = 153T-XXXX	TiAlN = 153A-XXXX
TiCN = 153N-XXXX	AM200® = 153H-XXXX

Inserts sold in quantities of 1

## T-A® Drill Inserts

3 Series | Carbide | Diameter Range: 1.353" - 1.882" (34.36 mm - 47.80 mm)

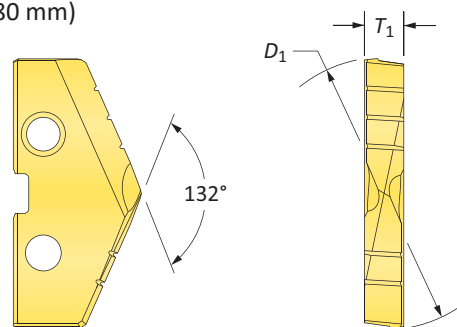

### Carbide Inserts – C2 (K20)

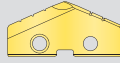
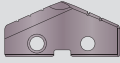
Fractional Equivalent	Insert			Part No.	
	$D_1$ inch	$D_1$ mm	$T_1$	 TiN	 TiAlN
1-13/32	1.4063	35.72	1/4	1C23T-0113	1C23A-0113
-	1.4173	36.00	1/4	1C23T-36	1C23A-36
1-7/16	1.4375	36.51	1/4	1C23T-0114	1C23A-0114
-	1.4567	37.00	1/4	1C23T-37	1C23A-37
1-15/32	1.4688	37.31	1/4	1C23T-0115	1C23A-0115
-	1.4961	38.00	1/4	1C23T-38	1C23A-38
1-1/2	1.5000	38.10	1/4	1C23T-0116	1C23A-0116
1-17/32	1.5313	38.89	1/4	1C23T-0117	1C23A-0117
-	1.5354	39.00	1/4	1C23T-39	1C23A-39
-	1.5470	39.29	1/4	1C23T-1.547	1C23A-1.547
1-9/16	1.5625	39.69	1/4	1C23T-0118	1C23A-0118
-	1.5748	40.00	1/4	1C23T-40	1C23A-40
1-19/32	1.5938	40.48	1/4	1C23T-0119	1C23A-0119
-	1.6142	41.00	1/4	1C23T-41	1C23A-41
1-5/8	1.6250	41.28	1/4	1C23T-0120	1C23A-0120
-	1.6535	42.00	1/4	1C23T-42	1C23A-42
1-21/32	1.6563	42.07	1/4	1C23T-0121	1C23A-0121
1-11/16	1.6875	42.86	1/4	1C23T-0122	1C23A-0122
-	1.6929	43.00	1/4	1C23T-43	1C23A-43
1-23/32	1.7188	43.66	1/4	1C23T-0123	1C23A-0123
-	1.7323	44.00	1/4	1C23T-44	1C23A-44
1-3/4	1.7500	44.45	1/4	1C23T-0124	1C23A-0124
-	1.7717	45.00	1/4	1C23T-45	1C23A-45
1-25/32	1.7813	45.24	1/4	1C23T-0125	1C23A-0125
-	1.7913	45.50	1/4	1C23T-45.5	1C23A-45.5
-	1.7970	45.64	1/4	1C23T-1.797	1C23A-1.797
-	1.8110	46.00	1/4	1C23T-46	1C23A-46
1-13/16	1.8125	46.04	1/4	1C23T-0126	1C23A-0126
1-27/32	1.8438	46.83	1/4	1C23T-0127	1C23A-0127
-	1.8504	47.00	1/4	1C23T-47	1C23A-47
1-7/8	1.8750	47.63	1/4	1C23T-0128	1C23A-0128

Inserts sold in quantities of 1

A30: 112 - 143

A30: 82 - 85

A30: 4 - 6

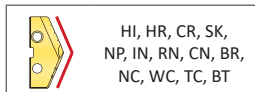
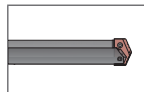
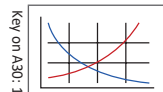

Coatings not listed above can be supplied as non-stocked standards. Process fees apply. →

TiN = 1C23T-XXXX	TiAlN = 1C23A-XXXX
TiCN = 1C23N-XXXX	AM200® = 1C23H-XXXX



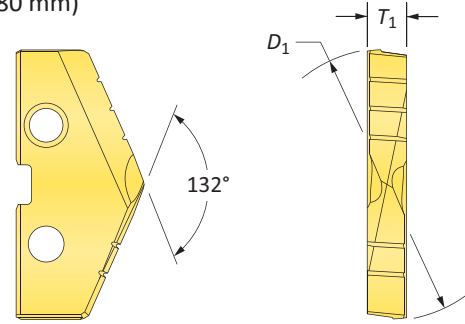

**T-A® Drill Inserts**

3 Series | Carbide | Diameter Range: 1.353" - 1.882" (34.36 mm - 47.80 mm)

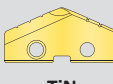

**Carbide Inserts – C5 (P40)**

Fractional Equivalent	Insert			Part No.	
	$D_1$ inch	$D_1$ mm	$T_1$	 TiN	 TiAlN
1-13/32	1.4063	35.72	1/4	1C53T-0113	1C53A-0113
-	1.4173	36.00	1/4	1C53T-36	1C53A-36
1-7/16	1.4375	36.51	1/4	1C53T-0114	1C53A-0114
-	1.4567	37.00	1/4	1C53T-37	1C53A-37
1-15/32	1.4688	37.31	1/4	1C53T-0115	1C53A-0115
-	1.4961	38.00	1/4	1C53T-38	1C53A-38
1-1/2	1.5000	38.10	1/4	1C53T-0116	1C53A-0116
1-17/32	1.5313	38.89	1/4	1C53T-0117	1C53A-0117
-	1.5354	39.00	1/4	1C53T-39	1C53A-39
-	1.5470	39.29	1/4	1C53T-1.547	1C53A-1.547
1-9/16	1.5625	39.69	1/4	1C53T-0118	1C53A-0118
-	1.5748	40.00	1/4	1C53T-40	1C53A-40
1-19/32	1.5938	40.48	1/4	1C53T-0119	1C53A-0119
-	1.6142	41.00	1/4	1C53T-41	1C53A-41
1-5/8	1.6250	41.28	1/4	1C53T-0120	1C53A-0120
-	1.6535	42.00	1/4	1C53T-42	1C53A-42
1-21/32	1.6563	42.07	1/4	1C53T-0121	1C53A-0121
1-11/16	1.6875	42.86	1/4	1C53T-0122	1C53A-0122
-	1.6929	43.00	1/4	1C53T-43	1C53A-43
1-23/32	1.7188	43.66	1/4	1C53T-0123	1C53A-0123
-	1.7323	44.00	1/4	1C53T-44	1C53A-44
1-3/4	1.7500	44.45	1/4	1C53T-0124	1C53A-0124
-	1.7717	45.00	1/4	1C53T-45	1C53A-45
1-25/32	1.7813	45.24	1/4	1C53T-0125	1C53A-0125
-	1.7913	45.50	1/4	1C53T-45.5	1C53A-45.5
-	1.7970	45.64	1/4	1C53T-1.797	1C53A-1.797
-	1.8110	46.00	1/4	1C53T-46	1C53A-46
1-13/16	1.8125	46.04	1/4	1C53T-0126	1C53A-0126
1-27/32	1.8438	46.83	1/4	1C53T-0127	1C53A-0127
-	1.8504	47.00	1/4	1C53T-47	1C53A-47
1-7/8	1.8750	47.63	1/4	1C53T-0128	1C53A-0128

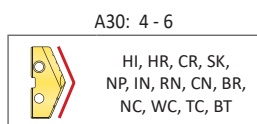
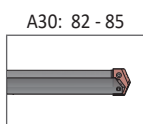
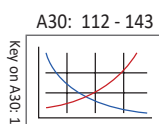

Inserts sold in quantities of 1

Coatings not listed above can be supplied as non-stocked standards. Process fees apply. →

TiN = 1C53T-XXXX	TiAlN = 1C53A-XXXX
TiCN = 1C53N-XXXX	AM200® = 1C53H-XXXX

## T-A® Drill Insert Holders

3 Series | Flange Shank | Diameter Range: 1.353" - 1.882" (34.36 mm - 47.80 mm)

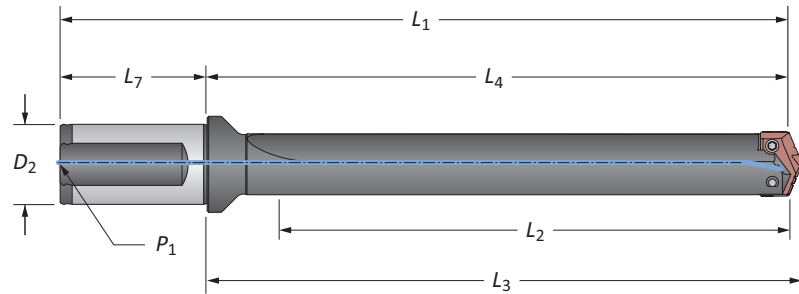

### Straight Flute

Length	Body				Shank			Part No.
	$L_2$	$L_4$	$L_3$	$L_1$	$D_2$	$L_7$	$P_1$	
<b>i</b> Short	4-3/4	6-13/16	7	9-1/2	1-1/2	2-11/16	1/4	22030S-150F
<b>i</b> Intermediate	6-1/2	8-9/16	8-3/4	11-1/4	1-1/2	2-11/16	1/4	23030S-150F
<b>i</b> Standard	8-1/4	10-5/16	10-1/2	13	1-1/2	2-11/16	1/4	24030S-150F
<b>m</b> Short	120.7	173.0	177.8	243.0	40.0	70.0	1/4*	22030S-40FM
<b>m</b> Extended	349.3	401.6	406.4	471.6	40.0	70.0	1/4*	<b>▲ 25030S-40FM</b>
<b>m</b> XL	558.8	611.1	615.9	681.1	40.0	70.0	1/4*	<b>▲ 27030S-40FM</b>
<b>m</b> 3XL	787.4	839.7	844.5	909.7	40.0	70.0	1/4*	<b>▲ 29030S-40FM</b>

\*Metric thread to BSP and ISO 7-1

**NOTE:** Stub length holders have a 1/4" side pipe tap ( $P_2$ )

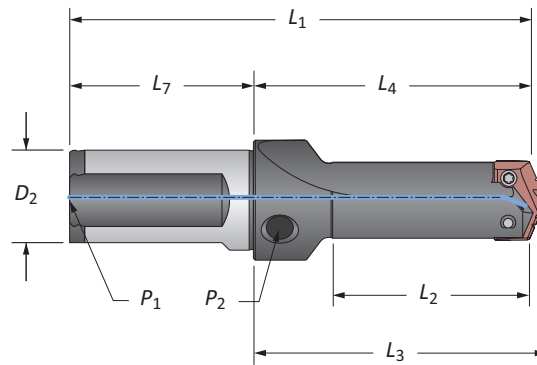

### Straight Flute (Stub Length)

Length	Body				Shank			Part No.
	$L_2$	$L_4$	$L_3$	$L_1$	$D_2$	$L_7$	$P_1$	
<b>i</b> Stub	3	4-59/64	5-7/64	7-39/64	1-1/2	2-11/16	1/4	21030S-150F
<b>m</b> Stub	76.2	125.0	129.8	195.0	40.0	70.0	1/4*	21030S-40FM

\*Metric thread to BSP and ISO 7-1

**NOTE:** Stub length holders have a 1/4" side pipe tap ( $P_2$ )

### Connection Accessories

Insert Screws	Nylon Locking Screws	Insert Driver	Preset Torque Hand Driver	Replacement Tips	Admissible Tightening Torque*
7514-IP20-1	7514N-IP20-1	8IP-20	-	-	121.3 in-lbs (1370 N-cm)

\*Tightening torques are calculated with a friction coefficient of  $\mu = 0.14$  and develop 90% of ultimate yield strength

A30: 74 - 81

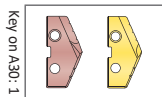

**i** = Imperial (in)

**m** = Metric (mm)

Screws sold in quantities of 10

**WARNING** Refer to Speed and Feed charts for recommended adjustments to speeds and feeds. Refer to page A30: 146 for deep hole drilling guidelines in this section of the catalog. Visit [www.alliedmachine.com/DeepHoleGuidelines](http://www.alliedmachine.com/DeepHoleGuidelines) for the most up-to-date information and procedures. Factory technical assistance is available for your specific applications through our Application Engineering Team.



### T-A® Drill Insert Holders

3 Series | Flange Shank | Diameter Range: 1.353" - 1.882" (34.36 mm - 47.80 mm)

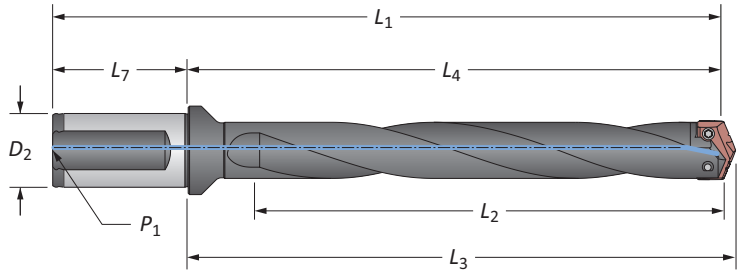

#### Helical Flute

Length	Body				Shank			Part No.	
	L <sub>2</sub>	L <sub>4</sub>	L <sub>3</sub>	L <sub>1</sub>	D <sub>2</sub>	L <sub>7</sub>	P <sub>1</sub>		
i	Intermediate	6-1/2	8-9/16	8-3/4	11-1/4	1-1/2	2-11/16	1/4	23030H-150F
	Standard	8-1/4	10-5/16	10-1/2	13	1-1/2	2-11/16	1/4	24030H-150F
m	Intermediate	165.1	217.5	222.3	287.5	40.0	70.0	1/4*	23030H-40FM
	Standard	209.6	261.9	266.7	331.9	40.0	70.0	1/4*	24030H-40FM

\*Metric thread to BSP and ISO 7-1

#### Connection Accessories

Insert Screws	Nylon Locking Screws	Insert Driver	Preset Torque Hand Driver	Replacement Tips	Admissible Tightening Torque*
7514-IP20-1	7514N-IP20-1	8IP-20	-	-	121.3 in-lbs (1370 N-cm)

\*Tightening torques are calculated with a friction coefficient of  $\mu = 0.14$  and develop 90% of ultimate yield strength

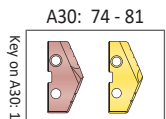

i = Imperial (in)  
m = Metric (mm)

Screws sold in quantities of 10

## T-A® Drill Insert Holders

3 Series | Taper Shank | Diameter Range: 1.353" - 1.882" (34.36 mm - 47.80 mm)

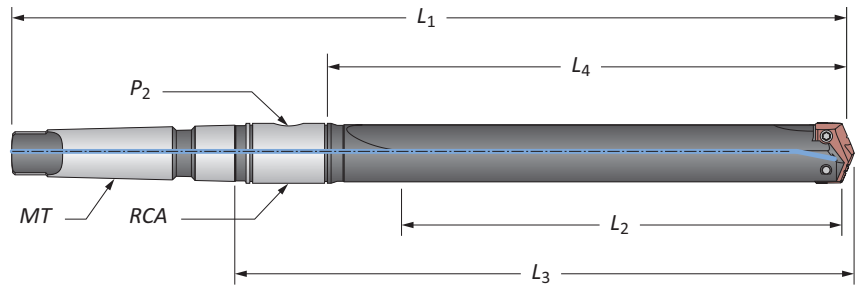

### Straight Flute

Length	Body				Shank			Part No.	
	L <sub>2</sub>	L <sub>4</sub>	L <sub>3</sub>	L <sub>1</sub>	MT	P <sub>2</sub>	RCA		
Short	4-3/4	6	8-1/8	12-9/16	#4	1/4	2T-4SR	22030S-004I	
	4-3/4	6	8-1/8	13-13/16	#5	1/4	2T-5SR	22030S-005I	
Intermediate	6-1/2	7-3/4	9-7/8	14-5/16	#4	1/4	2T-4SR	23030S-004I	
Standard	8-1/4	9-1/2	11-5/8	16-1/16	#4	1/4	2T-4SR	24030S-004I	
	8-1/4	9-1/2	11-5/8	17-5/16	#5	1/4	2T-5SR	24030S-005I	
Extended	13-3/4	15	17-1/8	21-9/16	#4	1/4	2T-4SR	25030S-004I	
XL	22	23-1/4	25-3/8	29-13/16	#4	1/4	2T-4SR	27030S-004I	
3XL	31	32-1/4	34-3/8	38-13/16	#4	1/4	2T-4SR	29030S-004I	
Metric	Short	120.6	152.4	206.4	319.1	#4**	1/4*	2T-4SRM	22030S-004M
	Extended	349.3	381.0	435.0	547.7	#4**	1/4*	2T-4SRM	25030S-004M
	XL	558.8	590.6	644.6	757.2	#4**	1/4*	2T-4SRM	27030S-004M
	3XL	787.4	819.2	873.2	985.8	#4**	1/4*	2T-4SRM	29030S-004M

\*Metric thread to BSP and ISO 7-1

\*\*Per ISO 296 type BEK

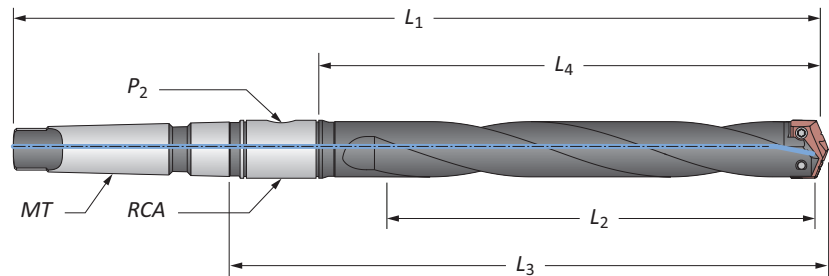

### Helical Flute

Length	Body				Shank			Part No.
	L <sub>2</sub>	L <sub>4</sub>	L <sub>3</sub>	L <sub>1</sub>	MT	P <sub>2</sub>	RCA	
Intermediate	165.1	196.9	250.9	363.6	#4**	1/4*	2T-4SRM	23030H-004M
Standard	209.5	241.3	295.3	408.0	#4**	1/4*	2T-4SRM	24030H-004M

\*Metric thread to BSP and ISO 7-1 | \*\*Per ISO 296 type BEK

### Connection Accessories

Insert Screws	Nylon Locking Screws	Insert Driver	Preset Torque Hand Driver	Replacement Tips	Admissible Tightening Torque*
7514-IP20-1	7514N-IP20-1	8IP-20	-	-	121.3 in-lbs (1370 N-cm)

\*Tightening torques are calculated with a friction coefficient of  $\mu = 0.14$  and develop 90% of ultimate yield strength

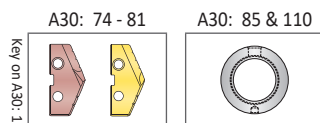

**i** = Imperial (in)

**m** = Metric (mm)

Screws sold in quantities of 10

**WARNING** Refer to Speed and Feed charts for recommended adjustments to speeds and feeds. Refer to page A30: 146 for deep hole drilling guidelines in this section of the catalog. Visit [www.alliedmachine.com/DeepHoleGuidelines](http://www.alliedmachine.com/DeepHoleGuidelines) for the most up-to-date information and procedures. Factory technical assistance is available for your specific applications through our Application Engineering Team.

### T-A® Drill Insert Holders

3 Series | Straight Shank | Diameter Range: 1.353" - 1.882" (34.36 mm - 47.80 mm)

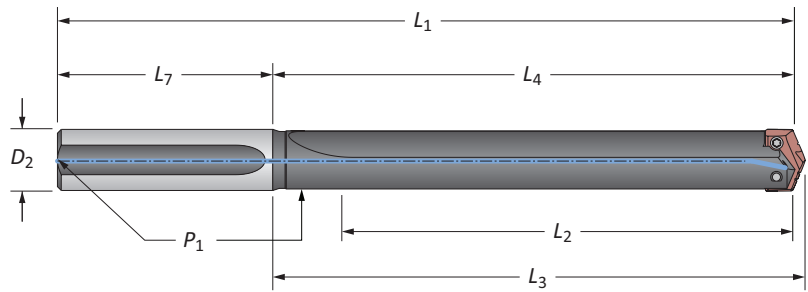

#### Straight Flute

Length	Body				Shank			Part No.
	L <sub>2</sub>	L <sub>4</sub>	L <sub>3</sub>	L <sub>1</sub>	D <sub>2</sub>	L <sub>7</sub>	P <sub>1</sub>	
Short	4-3/4	6	6-3/16	10	1-1/4	4	1/4	22030S-125L
Short	4-3/4	6	6-3/16	10	1-1/2	4	1/4	22030S-150L
Intermediate	6-1/2	7-3/4	7-15/16	11-3/4	1-1/2	4	1/4	23030S-150L
Standard	8-1/4	9-1/2	9-11/16	13-1/2	1-1/4	4	1/4	24030S-125L
Standard	8-1/4	9-1/2	9-11/16	13-1/2	1-1/2	4	1/4	24030S-150L
Extended	13-3/4	15-3/16	15	19	1-1/4	4	1/4	25030S-125L
XL	22	23-1/4	23-7/16	27-1/4	1-1/2	4	1/4	27030S-150L
3XL	31	32-1/4	32-7/16	36-1/4	1-1/2	4	1/4	29030S-150L

### T-A Drill Accessories

3 Series | Rotary Coolant Adapters | Torx® Plus Screws

#### Rotary Coolant Adapter (RCA) and Accessories

ID	OD	L <sub>1</sub>	Driving Rod Thread	P <sub>1</sub>	Part No.	RCA O-Rings	
						Kit Part No.**	Replacements
1-1/4	2-1/2	1-3/8	3/8-16	1/4	2T-4SR	2T1-4SR	2T1-4OR-10
1-3/4	3	1-3/8	3/8-16	1/4	2T-5SR	2T1-5SR	2T1-5OR-10
31.75	63.50	34.92	M10 x 1.50	1/4*	2T-4SRM	2T1-4SR	2T1-4OR-10
44.45	76.20	34.92	M10 x 1.50	1/4*	2T-5SRM	2T1-5SR	2T1-5OR-10

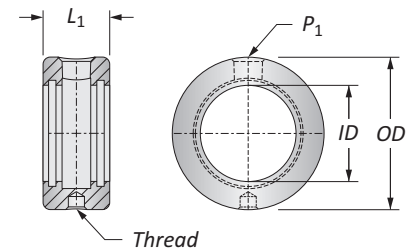

\*Thread to BSP and ISO 7-1

\*\*RCA Repair Kit includes (2) O-rings, (2) snap rings, and (2) thrust washers

Refer to page A30: 110 for proper RCA assembly and safety information

#### Connection Accessories

Insert Screws	Nylon Locking Screws	Insert Driver	Preset Torque Hand Driver	Replacement Tips	Admissible Tightening Torque*
7514-IP20-1	7514N-IP20-1	8IP-20	-	-	121.3 in-lbs (1370 N-cm)

\*Tightening torques are calculated with a friction coefficient of  $\mu = 0.14$  and develop 90% of ultimate yield strength

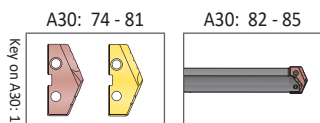

ⓘ = Imperial (in)

Ⓜ = Metric (mm)

Inserts sold separately  
Screws sold in packs of 10  
O-rings sold in packs of 10



**WARNING** Refer to Speed and Feed charts for recommended adjustments to speeds and feeds. Refer to page A30: 146 for deep hole drilling guidelines in this section of the catalog. Visit [www.alliedmachine.com/DeepHoleGuidelines](http://www.alliedmachine.com/DeepHoleGuidelines) for the most up-to-date information and procedures. Factory technical assistance is available for your specific applications through our Application Engineering Team.

## GEN2 T-A® Drill Inserts

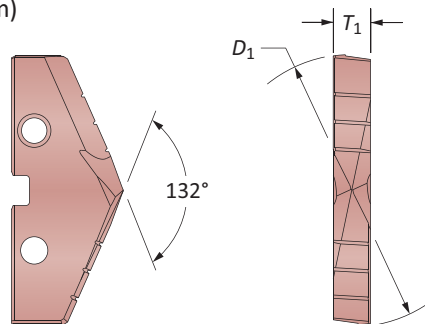
4 Series | HSS | Diameter Range: 1.850" - 2.570" (46.99 mm - 65.28 mm)

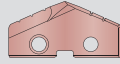

### HSS Inserts – Super Cobalt

Fractional Equivalent	Insert			Part No.	
	$D_1$ inch	$D_1$ mm	$T_1$	 AM200®	 TiN
–	1.8898	48.00	5/16	454H-48	454T-48
1-29/32	1.9063	48.42	5/16	454H-0129	454T-0129
–	1.9291	49.00	5/16	454H-49	454T-49
1-15/16	1.9375	49.21	5/16	454H-0130	454T-0130
–	1.9685	50.00	5/16	454H-50	454T-50
1-31/32	1.9688	50.01	5/16	454H-0131	454T-0131
2	2.0000	50.80	5/16	454H-0200	454T-0200
–	2.0079	51.00	5/16	454H-51	454T-51
2-1/32	2.0313	51.59	5/16	454H-0201	454T-0201
2-3/64	2.0472	52.00	5/16	454H-52	454T-52
2-1/16	2.0625	52.39	5/16	454H-0202	454T-0202
–	2.0866	53.00	5/16	454H-53	454T-53
2-3/32	2.0938	53.18	5/16	454H-0203	454T-0203
2-1/8	2.1250	53.98	5/16	454H-0204	454T-0204
–	2.1260	54.00	5/16	454H-54	454T-54
2-5/32	2.1563	54.77	5/16	454H-0205	454T-0205
–	2.1654	55.00	5/16	454H-55	454T-55
2-3/16	2.1875	55.56	5/16	454H-0206	454T-0206
–	2.2047	56.00	5/16	454H-56	454T-56
2-7/32	2.2188	56.36	5/16	454H-0207	454T-0207
–	2.2441	57.00	5/16	454H-57	454T-57
2-1/4	2.2500	57.15	5/16	454H-0208	454T-0208
2-9/32	2.2813	57.94	5/16	454H-0209	454T-0209
–	2.2835	58.00	5/16	454H-58	454T-58
2-5/16	2.3125	58.74	5/16	454H-0210	454T-0210
–	2.3228	59.00	5/16	454H-59	454T-59
2-11/32	2.3438	59.53	5/16	454H-0211	454T-0211
–	2.3622	60.00	5/16	454H-60	454T-60
2-3/8	2.3750	60.33	5/16	454H-0212	454T-0212
–	2.4016	61.00	5/16	454H-61	454T-61
2-13/32	2.4063	61.12	5/16	454H-0213	454T-0213
2-7/16	2.4375	61.91	5/16	454H-0214	454T-0214
–	2.4409	62.00	5/16	454H-62	454T-62
2-15/32	2.4688	62.71	5/16	454H-0215	454T-0215
–	2.4803	63.00	5/16	454H-63	454T-63
2-1/2	2.5000	63.50	5/16	454H-0216	454T-0216
–	2.5197	64.00	5/16	454H-64	454T-64
2-17/32	2.5313	64.29	5/16	454H-0217	454T-0217
–	2.5591	65.00	5/16	454H-65	454T-65
2-9/16	2.5625	65.09	5/16	454H-0218	454T-0218

Inserts sold in quantities of 1

A30: 112 - 143

A30: 90 - 92

A30: 4 - 6

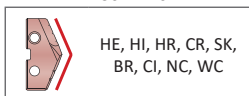
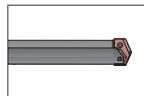
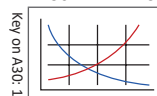

Coatings not listed above can be supplied as non-stocked standards. Process fees apply. →

TiN = 454T-XXXX	TiAlN = 454A-XXXX
TiCN = 454N-XXXX	AM200® = 454H-XXXX

**GEN2 T-A® Drill Inserts**

4 Series | HSS | Diameter Range: 1.850" - 2.570" (46.99 mm - 65.28 mm)

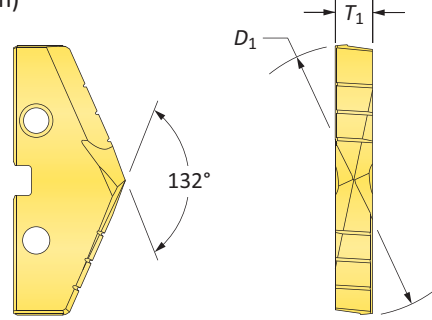

**HSS Inserts – HSS**

Fractional Equivalent	Insert			Part No.
	D <sub>1</sub> inch	D <sub>1</sub> mm	T <sub>1</sub>	
-	1.8898	48.00	5/16	434T-48
1-29/32	1.9063	48.42	5/16	434T-0129
-	1.9291	49.00	5/16	434T-49
1-15/16	1.9375	49.21	5/16	434T-0130
-	1.9685	50.00	5/16	434T-50
1-31/32	1.9688	50.01	5/16	434T-0131
2	2.0000	50.80	5/16	434T-0200
-	2.0079	51.00	5/16	434T-51
2-1/32	2.0313	51.59	5/16	434T-0201
2-3/64	2.0472	52.00	5/16	434T-52
2-1/16	2.0625	52.39	5/16	434T-0202
-	2.0866	53.00	5/16	434T-53
2-3/32	2.0938	53.18	5/16	434T-0203
2-1/8	2.1250	53.98	5/16	434T-0204
-	2.1260	54.00	5/16	434T-54
2-5/32	2.1563	54.77	5/16	434T-0205
-	2.1654	55.00	5/16	434T-55
2-3/16	2.1875	55.56	5/16	434T-0206
-	2.2047	56.00	5/16	434T-56
2-7/32	2.2188	56.36	5/16	434T-0207
-	2.2441	57.00	5/16	434T-57
2-1/4	2.2500	57.15	5/16	434T-0208
2-9/32	2.2813	57.94	5/16	434T-0209
-	2.2835	58.00	5/16	434T-58
2-5/16	2.3125	58.74	5/16	434T-0210
-	2.3228	59.00	5/16	434T-59
2-11/32	2.3438	59.53	5/16	434T-0211
-	2.3622	60.00	5/16	434T-60
2-3/8	2.3750	60.33	5/16	434T-0212
-	2.4016	61.00	5/16	434T-61
2-13/32	2.4063	61.12	5/16	434T-0213
2-7/16	2.4375	61.91	5/16	434T-0214
-	2.4409	62.00	5/16	434T-62
2-15/32	2.4688	62.71	5/16	434T-0215
-	2.4803	63.00	5/16	434T-63
2-1/2	2.5000	63.50	5/16	434T-0216
-	2.5197	64.00	5/16	434T-64
2-17/32	2.5313	64.29	5/16	434T-0217
-	2.5591	65.00	5/16	434T-65
2-9/16	2.5625	65.09	5/16	434T-0218

A30: 112 - 143 A30: 90 - 92 A30: 4 - 6 HE, HI, HR, CR, SK, BR, CI, NC, WC

Coatings not listed above can be supplied as non-stocked standards. Process fees apply. →

TiN = 434T-XXXX	TiAlN = 434A-XXXX
TiCN = 434N-XXXX	AM200® = 434H-XXXX

Inserts sold in quantities of 1

## T-A® Drill Inserts

4 Series | HSS | Diameter Range: 1.850" - 2.570" (46.99 mm - 65.28 mm)

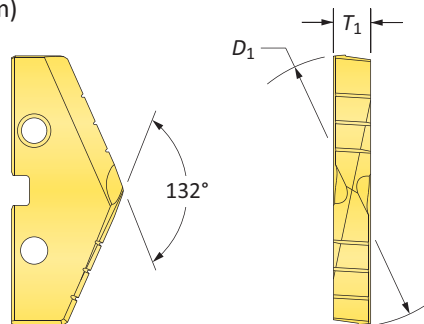

### HSS Inserts – Super Cobalt

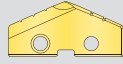
Fractional Equivalent	Insert			Part No.
	$D_1$ inch	$D_1$ mm	$T_1$	 TiN
-	1.8898	48.00	5/16	154T-48
1-29/32	1.9063	48.42	5/16	154T-0129
-	1.9291	49.00	5/16	154T-49
1-15/16	1.9375	49.21	5/16	154T-0130
-	1.9685	50.00	5/16	154T-50
1-31/32	1.9688	50.01	5/16	154T-0131
2	2.0000	50.80	5/16	154T-0200
-	2.0079	51.00	5/16	154T-51
2-1/32	2.0313	51.59	5/16	154T-0201
2-3/64	2.0472	52.00	5/16	154T-52
2-1/16	2.0625	52.39	5/16	154T-0202
-	2.0866	53.00	5/16	154T-53
2-3/32	2.0938	53.18	5/16	154T-0203
2-1/8	2.1250	53.98	5/16	154T-0204
-	2.1260	54.00	5/16	154T-54
2-5/32	2.1563	54.77	5/16	154T-0205
-	2.1654	55.00	5/16	154T-55
2-3/16	2.1875	55.56	5/16	154T-0206
-	2.2047	56.00	5/16	154T-56
2-7/32	2.2188	56.36	5/16	154T-0207
-	2.2441	57.00	5/16	154T-57
2-1/4	2.2500	57.15	5/16	154T-0208
2-9/32	2.2813	57.94	5/16	154T-0209
-	2.2835	58.00	5/16	154T-58
2-5/16	2.3125	58.74	5/16	154T-0210
-	2.3228	59.00	5/16	154T-59
2-11/32	2.3438	59.53	5/16	154T-0211
-	2.3622	60.00	5/16	154T-60
2-3/8	2.3750	60.33	5/16	154T-0212
-	2.4016	61.00	5/16	154T-61
2-13/32	2.4063	61.12	5/16	154T-0213
2-7/16	2.4375	61.91	5/16	154T-0214
-	2.4409	62.00	5/16	154T-62
2-15/32	2.4688	62.71	5/16	154T-0215
-	2.4803	63.00	5/16	154T-63
2-1/2	2.5000	63.50	5/16	154T-0216
-	2.5197	64.00	5/16	154T-64
2-17/32	2.5313	64.29	5/16	154T-0217
-	2.5591	65.00	5/16	154T-65
2-9/16	2.5625	65.09	5/16	154T-0218

Inserts sold in quantities of 1

A30: 112 - 143

A30: 90 - 92

A30: 4 - 6

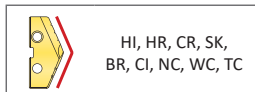
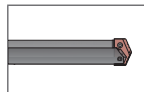
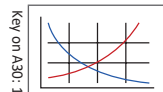

Coatings not listed above  
can be supplied as  
non-stocked standards.  
Process fees apply. →

TiN = 154T-XXXX

TiAlN = 154A-XXXX

TiCN = 154N-XXXX

AM200® = 154H-XXXX





T-A® Drill Inserts

4 Series | HSS | Diameter Range: 1.850" - 2.570" (46.99 mm - 65.28 mm)



Flat Bottom

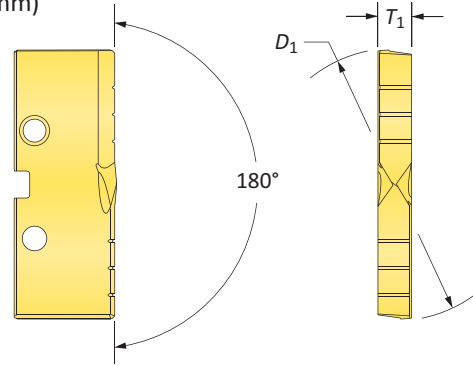

HSS Inserts – Super Cobalt

Fractional Equivalent	Insert			Part No.
	D <sub>1</sub> inch	D <sub>1</sub> mm	T <sub>1</sub>	
-	1.8898	48.00	5/16	154T-48-FB
1-29/32	1.9063	48.42	5/16	154T-0129-FB
-	1.9291	49.00	5/16	154T-49-FB
1-15/16	1.9375	49.21	5/16	154T-0130-FB
-	1.9685	50.00	5/16	154T-50-FB
1-31/32	1.9688	50.01	5/16	154T-0131-FB
2	2.0000	50.80	5/16	154T-0200-FB
-	2.0079	51.00	5/16	154T-51-FB
2-1/32	2.0313	51.59	5/16	154T-0201-FB
2-3/64	2.0472	52.00	5/16	154T-52-FB
2-1/16	2.0625	52.39	5/16	154T-0202-FB
-	2.0866	53.00	5/16	154T-53-FB
2-3/32	2.0938	53.18	5/16	154T-0203-FB
2-1/8	2.1250	53.98	5/16	154T-0204-FB
-	2.1260	54.00	5/16	154T-54-FB
2-5/32	2.1563	54.77	5/16	154T-0205-FB
-	2.1654	55.00	5/16	154T-55-FB
2-3/16	2.1875	55.56	5/16	154T-0206-FB
-	2.2047	56.00	5/16	154T-56-FB
2-7/32	2.2188	56.36	5/16	154T-0207-FB
-	2.2441	57.00	5/16	154T-57-FB
2-1/4	2.2500	57.15	5/16	154T-0208-FB
2-9/32	2.2813	57.94	5/16	154T-0209-FB
-	2.2835	58.00	5/16	154T-58-FB
2-5/16	2.3125	58.74	5/16	154T-0210-FB
-	2.3228	59.00	5/16	154T-59-FB
2-11/32	2.3438	59.53	5/16	154T-0211-FB
-	2.3622	60.00	5/16	154T-60-FB
2-3/8	2.3750	60.33	5/16	154T-0212-FB
-	2.4016	61.00	5/16	154T-61-FB
2-13/32	2.4063	61.12	5/16	154T-0213-FB
2-7/16	2.4375	61.91	5/16	154T-0214-FB
-	2.4409	62.00	5/16	154T-62-FB
2-15/32	2.4688	62.71	5/16	154T-0215-FB
-	2.4803	63.00	5/16	154T-63-FB
2-1/2	2.5000	63.50	5/16	154T-0216-FB
-	2.5197	64.00	5/16	154T-64-FB
2-17/32	2.5313	64.29	5/16	154T-0217-FB
-	2.5591	65.00	5/16	154T-65-FB
2-9/16	2.5625	65.09	5/16	154T-0218-FB

Key on A30-1

A30: 112 - 143

A30: 90 - 92

A30: 4 - 6

Coatings not listed above can be supplied as non-stocked standards. Process fees apply. →

TiN = 154T-XXXX	TiAlN = 154A-XXXX
TiCN = 154N-XXXX	AM200® = 154H-XXXX

Inserts sold in quantities of 1

## T-A® Drill Insert Holders

4 Series | Flange Shank | Diameter Range: 1.850" - 2.570" (46.99 mm - 65.28 mm)

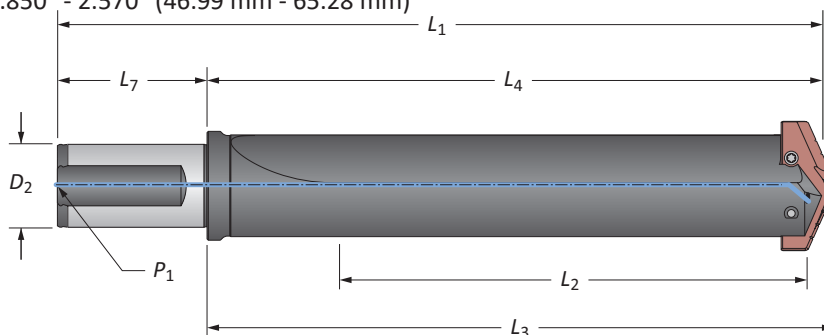

### Straight Flute

	Length	Body				Shank			Part No.
		L <sub>2</sub>	L <sub>4</sub>	L <sub>3</sub>	L <sub>1</sub>	D <sub>2</sub>	L <sub>7</sub>	P <sub>1</sub>	
i	Short	5-1/8	7-1/16	7-1/4	9-3/4	1-1/2	2-11/16	1/4	22040S-150F
	Standard	9-1/8	11-1/16	11-1/4	13-3/4	1-1/2	2-11/16	1/4	24040S-150F
m	Short	130.2	179.4	184.0	249.4	40.0	70.0	1/4*	22040S-40FM
	Extended	422.3	471.5	476.0	541.5	40.0	70.0	1/4*	25040S-40FM
	XL	625.0	674.7	679.0	744.7	40.0	70.0	1/4*	27040S-40FM
	3XL	879.0	928.7	933.0	998.7	40.0	70.0	1/4*	29040S-40FM

\*Metric thread to BSP and ISO 7-1

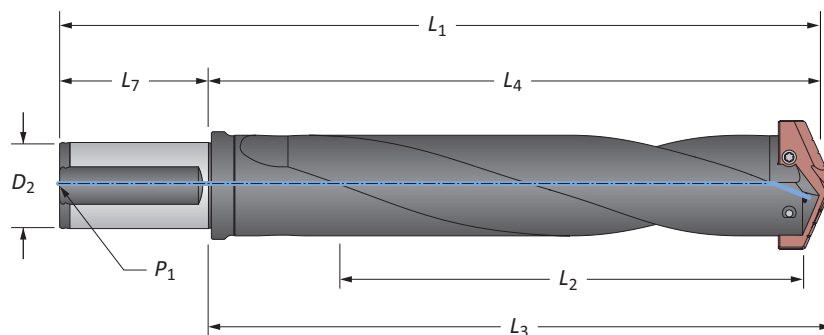

### Helical Flute

	Length	Body				Shank			Part No.
		L <sub>2</sub>	L <sub>4</sub>	L <sub>3</sub>	L <sub>1</sub>	D <sub>2</sub>	L <sub>7</sub>	P <sub>1</sub>	
i	Standard	9-1/8	11-1/16	11-1/4	13-3/4	1-1/2	2-11/16	1/4	24040H-150F
m	Standard	231.8	281.0	285.8	351.0	40.0	70.0	1/4*	24040H-40FM

\*Metric thread to BSP and ISO 7-1

### Connection Accessories

Insert Screws	Nylon Locking Screws	Insert Driver	Preset Torque Hand Driver	Replacement Tips	Admissible Tightening Torque*
7514-IP20-1	7514N-IP20-1	8IP-20	-	-	121.3 in-lbs (1370 N-cm)

\*Tightening torques are calculated with a friction coefficient of  $\mu = 0.14$  and develop 90% of ultimate yield strength

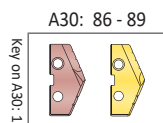

i = Imperial (in)

m = Metric (mm)

Screws sold in quantities of 10

**WARNING** Refer to Speed and Feed charts for recommended adjustments to speeds and feeds. Refer to page A30: 146 for deep hole drilling guidelines in this section of the catalog. Visit [www.alliedmachine.com/DeepHoleGuidelines](http://www.alliedmachine.com/DeepHoleGuidelines) for the most up-to-date information and procedures. Factory technical assistance is available for your specific applications through our Application Engineering Team.

### T-A® Drill Insert Holders

4 Series | Taper Shank | Diameter Range: 1.850" - 2.570" (46.99 mm - 65.28 mm)

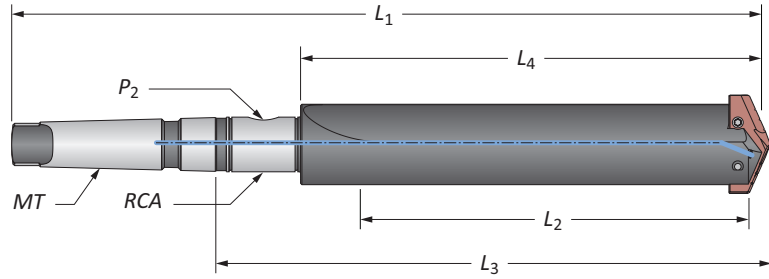

#### Straight Flute

	Length	Body				Shank			Part No.
		L <sub>2</sub>	L <sub>4</sub>	L <sub>3</sub>	L <sub>1</sub>	MT	P <sub>2</sub>	RCA	
i	Short	5-1/8	6-1/2	8-5/8	13-1/16	#4	1/4	2T-4SR	22040S-004I
	Short	5-1/8	6-1/2	8-5/8	14-5/16	#5	1/4	2T-5SR	22040S-005I
	Standard	9-1/8	10-1/2	12-5/8	17-1/16	#4	1/4	2T-4SR	24040S-004I
	Standard	9-1/8	10-1/2	12-5/8	18-5/16	#5	1/4	2T-5SR	24040S-005I
	Extended	16-5/8	18	20-1/8	25-13/16	#5	1/4	2T-5SR	25040S-005I
	XL	24-5/8	26	28-1/8	33-13/16	#5	1/4	2T-5SR	27040S-005I
m	3XL	34-5/8	36	38-1/8	43-13/16	#5	1/4	2T-5SR	29040S-005I
	Short	130.1	165.1	219.1	363.5	#5**	1/4*	2T-5SRM	22040S-005M
	Extended	422.3	457.2	511.2	655.6	#5**	1/4*	2T-5SRM	25040S-005M
	XL	625.0	660.4	714.4	858.8	#5**	1/4*	2T-5SRM	27040S-005M
	3XL	879.0	914.4	968.4	1112.8	#5**	1/4*	2T-5SRM	29040S-005M

\*Metric thread to BSP and ISO 7-1  
 \*\*Per ISO 296 type BEK

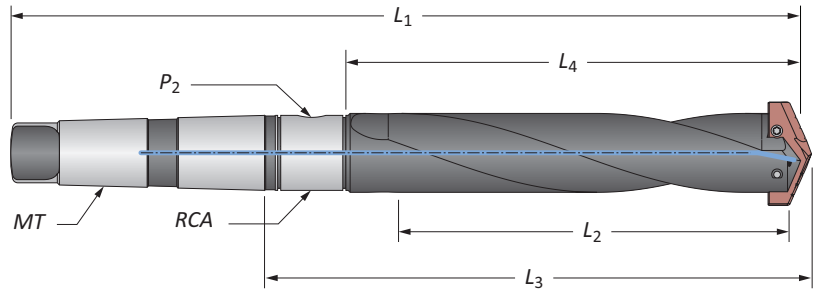

#### Helical Flute

	Length	Body				Shank			Part No.
		L <sub>2</sub>	L <sub>4</sub>	L <sub>3</sub>	L <sub>1</sub>	MT	P <sub>2</sub>	RCA	
ii	Standard	231.8	266.7	320.7	465.1	#5**	1/4*	2T-5SRM	24040H-005M

\*Metric thread to BSP and ISO 7-1  
 \*\*Per ISO 296 type BEK

#### Connection Accessories

Insert Screws	Nylon Locking Screws	Insert Driver	Preset Torque Hand Driver	Replacement Tips	Admissible Tightening Torque*
7514-IP20-1	7514N-IP20-1	8IP-20	-	-	121.3 in-lbs (1370 N-cm)

\*Tightening torques are calculated with a friction coefficient of  $\mu = 0.14$  and develop 90% of ultimate yield strength

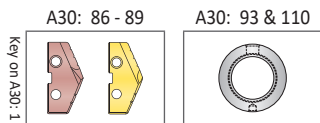

i = Imperial (in)  
 m = Metric (mm)

Screws sold in quantities of 10

**WARNING** Refer to Speed and Feed charts for recommended adjustments to speeds and feeds. Refer to page A30: 146 for deep hole drilling guidelines in this section of the catalog. Visit [www.alliedmachine.com/DeepHoleGuidelines](http://www.alliedmachine.com/DeepHoleGuidelines) for the most up-to-date information and procedures. Factory technical assistance is available for your specific applications through our Application Engineering Team.

A DRILLING  
 B BORING  
 C REAMING  
 D BURNISHING  
 E THREADING  
 X SPECIALS

## T-A® Drill Insert Holders

4 Series | Straight Shank | Diameter Range: 1.850" - 2.570" (46.99 mm - 65.28 mm)

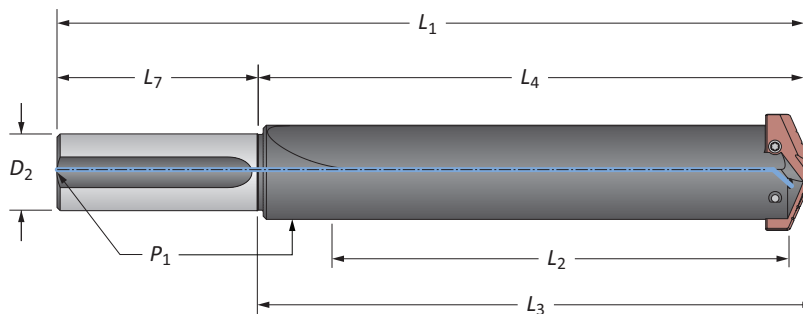

### Straight Flute

Length	Body				Shank			Part No.
	$L_2$	$L_4$	$L_3$	$L_1$	$D_2$	$L_7$	$P_1$	
Short	5-1/8	6-1/2	6-11/16	10-1/2	1-1/2	4	1/4	22040S-150L
Short	5-1/8	6-1/2	6-11/16	10-1/2	1-3/4	4	1/4	22040S-175L
Standard	9-1/8	10-1/2	10-11/16	14-1/2	1-1/2	4	1/4	24040S-150L
Standard	9-1/8	10-1/2	10-11/16	14-1/2	1-3/4	4	1/4	24040S-175L
Extended	16-5/8	18	18-3/16	22	1-1/2	4	1/4	25040S-150L
XL	24-5/8	26	26-3/16	30	1-1/2	4	1/4	27040S-150L
3XL	34-5/8	36	36-3/16	40	1-1/2	4	1/4	29040S-150L

### Connection Accessories

Insert Screws	Nylon Locking Screws	Insert Driver	Preset Torque Hand Driver	Replacement Tips	Admissible Tightening Torque*
7514-IP20-1	7514N-IP20-1	8IP-20	-	-	121.3 in-lbs (1370 N-cm)

\*Tightening torques are calculated with a friction coefficient of  $\mu = 0.14$  and develop 90% of ultimate yield strength

A30: 86 - 89

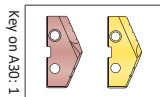

**i** = Imperial (in)

**m** = Metric (mm)

Screws sold in quantities of 10

**WARNING** Refer to Speed and Feed charts for recommended adjustments to speeds and feeds. Refer to page A30: 146 for deep hole drilling guidelines in this section of the catalog. Visit [www.alliedmachine.com/DeepHoleGuidelines](http://www.alliedmachine.com/DeepHoleGuidelines) for the most up-to-date information and procedures. Factory technical assistance is available for your specific applications through our Application Engineering Team.



T-A® Drill Accessories

4 Series | Rotary Coolant Adapters | Torx® Plus Screws

Rotary Coolant Adapter (RCA) and Accessories

	ID	OD	L <sub>1</sub>	Driving Rod Thread	P <sub>1</sub>	Part No.	RCA O-Rings	
							Kit Part No.**	Replacements
i	1-1/4	2-1/2	1-3/8	3/8-16	1/4	⚠ 2T-4SR	2T1-4SR	2T1-4OR-10
	1-3/4	3	1-3/8	3/8-16	1/4	⚠ 2T-5SR	2T1-5SR	2T1-5OR-10
m	31.75	63.50	34.92	M10 x 1.50	1/4*	⚠ 2T-4SRM	2T1-4SR	2T1-4OR-10
	44.45	76.20	34.92	M10 x 1.50	1/4*	⚠ 2T-5SRM	2T1-5SR	2T1-5OR-10

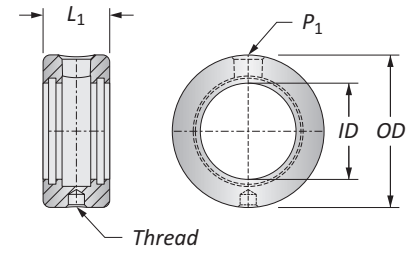

\*Thread to BSP and ISO 7-1

\*\*RCA Repair Kit includes (2) O-rings, (2) snap rings, and (2) thrust washers

⚠ Refer to page A30: 110 for proper RCA assembly and safety information

Connection Accessories

Insert Screws	Nylon Locking Screws	Insert Driver	Preset Torque Hand Driver	Replacement Tips	Admissible Tightening Torque*
7514-IP20-1	7514N-IP20-1	8IP-20	-	-	121.3 in-lbs (1370 N-cm)

\*Tightening torques are calculated with a friction coefficient of  $\mu = 0.14$  and develop 90% of ultimate yield strength

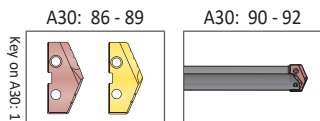

Key on A30: 1

i = Imperial (in)  
m = Metric (mm)

Inserts sold separately  
Screws sold in packs of 10  
O-rings sold in packs of 10



**⚠ WARNING** Refer to Speed and Feed charts for recommended adjustments to speeds and feeds. Refer to page A30: 146 for deep hole drilling guidelines in this section of the catalog. Visit [www.alliedmachine.com/DeepHoleGuidelines](http://www.alliedmachine.com/DeepHoleGuidelines) for the most up-to-date information and procedures. Factory technical assistance is available for your specific applications through our Application Engineering Team.

## GEN2 T-A® Drill Inserts

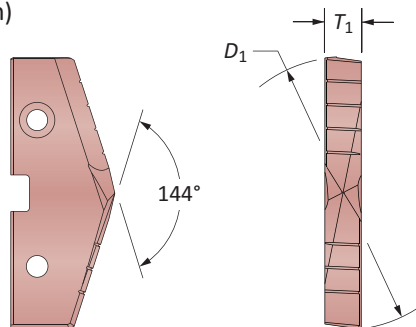
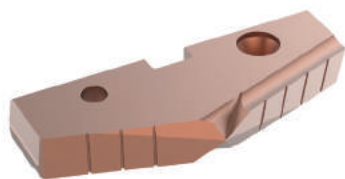
5 Series | HSS | Diameter Range: 2.456" - 3.000" (62.38 mm - 76.20 mm)

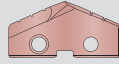

HSS Inserts – Super Cobalt | HSS

Fractional Equivalent	Insert			Super Cobalt Part No.	HSS Part No.
	$D_1$ inch	$D_1$ mm	$T_1$	 AM200®	 TiN
2-1/2	2.5000	63.50	7/16	455H-0216	435T-0216
–	2.5197	64.00	7/16	455H-64	435T-64
2-17/32	2.5313	64.29	7/16	455H-0217	435T-0217
2-9/16	2.5625	65.09	7/16	455H-0218	435T-0218
2-19/32	2.5938	65.88	7/16	455H-0219	435T-0219
–	2.5984	66.00	7/16	455H-66	435T-66
2-5/8	2.6250	66.68	7/16	455H-0220	435T-0220
2-21/32	2.6563	67.47	7/16	455H-0221	435T-0221
–	2.6772	68.00	7/16	455H-68	435T-68
2-11/16	2.6875	68.26	7/16	455H-0222	435T-0222
2-23/32	2.7188	69.05	7/16	455H-0223	435T-0223
2-3/4	2.7500	69.85	7/16	455H-0224	435T-0224
–	2.7559	70.00	7/16	455H-70	435T-70
2-25/32	2.7813	70.64	7/16	455H-0225	435T-0225
2-13/16	2.8125	71.44	7/16	455H-0226	435T-0226
–	2.8346	72.00	7/16	455H-72	435T-72
2-27/32	2.8438	72.23	7/16	455H-0227	435T-0227
2-7/8	2.8750	73.03	7/16	455H-0228	435T-0228
2-29/32	2.9063	73.82	7/16	455H-0229	435T-0229
–	2.9134	74.00	7/16	455H-74	435T-74
2-15/16	2.9375	74.41	7/16	455H-0230	435T-0230
2-31/32	2.9688	75.61	7/16	455H-0231	435T-0231
–	2.9921	76.00	7/16	455H-76	435T-76
3	3.0000	76.20	7/16	455H-0300	435T-0300

F

THREADING

X

SPECIALS

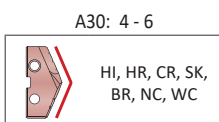
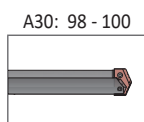
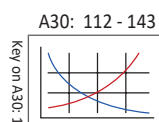

Coatings not listed above  
can be supplied as  
non-stocked standards.  
Process fees apply. →

TiN = 455T-XXXX	TiAlN = 455A-XXXX
TiCN = 455N-XXXX	AM200® = 455H-XXXX

Inserts sold in quantities of 1



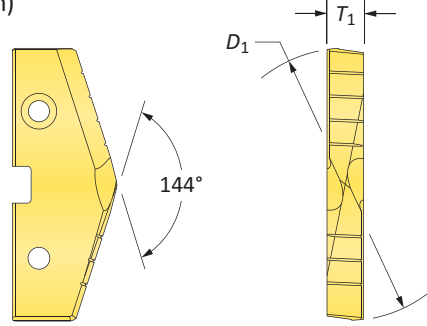
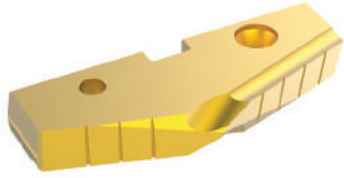

**T-A® Drill Inserts**

5 Series | HSS | Diameter Range: 2.456" - 3.000" (62.38 mm - 76.20 mm)



HSS Inserts – Super Cobalt | HSS

Fractional Equivalent	Insert			Super Cobalt Part No.*	HSS Part No.
	D <sub>1</sub> inch	D <sub>1</sub> mm	T <sub>1</sub>	 TiN	 TiN
2-1/2	2.5000	63.50	7/16	155T-0216	135T-0216
-	2.5197	64.00	7/16	155T-64	135T-64
2-17/32	2.5313	64.29	7/16	155T-0217	135T-0217
2-9/16	2.5625	65.09	7/16	155T-0218	135T-0218
2-19/32	2.5938	65.88	7/16	155T-0219	135T-0219
-	2.5984	66.00	7/16	155T-66	135T-66
2-5/8	2.6250	66.68	7/16	155T-0220	135T-0220
2-21/32	2.6563	67.47	7/16	155T-0221	135T-0221
-	2.6772	68.00	7/16	155T-68	135T-68
2-11/16	2.6875	68.26	7/16	155T-0222	135T-0222
2-23/32	2.7188	69.05	7/16	155T-0223	135T-0223
2-3/4	2.7500	69.85	7/16	155T-0224	135T-0224
-	2.7559	70.00	7/16	155T-70	135T-70
2-25/32	2.7813	70.64	7/16	155T-0225	135T-0225
2-13/16	2.8125	71.44	7/16	155T-0226	135T-0226
-	2.8346	72.00	7/16	155T-72	135T-72
2-27/32	2.8438	72.23	7/16	155T-0227	135T-0227
2-7/8	2.8750	73.03	7/16	155T-0228	135T-0228
2-29/32	2.9063	73.82	7/16	155T-0229	135T-0229
-	2.9134	74.00	7/16	155T-74	135T-74
2-15/16	2.9375	74.41	7/16	155T-0230	135T-0230
2-31/32	2.9688	75.61	7/16	155T-0231	135T-0231
-	2.9921	76.00	7/16	155T-76	135T-76
3	3.0000	76.20	7/16	155T-0300	135T-0300

\*Available as non-stocked standard

Key on A30-1

A30: 112 - 143

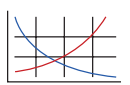

A30: 98 - 100



A30: 4 - 6



HI, HR, CR, SK,  
BR, NC, WC, TC

Coatings not listed above can be supplied as non-stocked standards. Process fees apply. →

TiN = 155T-XXXX	TiAlN = 155A-XXXX
TiCN = 155N-XXXX	AM200® = 155H-XXXX

Inserts sold in quantities of 1

A DRILLING  
B BORING  
C REAMING  
D BURNISHING  
E THREADING  
X SPECIALS



## GEN2 T-A® Drill Inserts

6 Series | HSS | Diameter Range: 3.001" - 3.507" (76.22 mm - 89.08 mm)

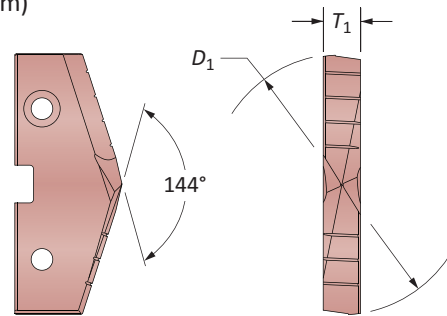
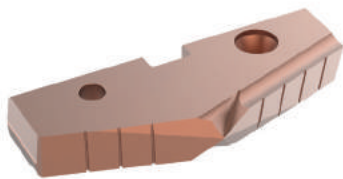
(for use with 5 series holders)

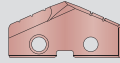

HSS Inserts – Super Cobalt | HSS

Fractional Equivalent	Insert			Super Cobalt Part No.	HSS Part No.
	$D_1$ inch	$D_1$ mm	$T_1$	 AM200®	 TiN
3-1/32	3.0313	76.99	7/16	456H-0301	436T-0301
3-1/16	3.0625	77.79	7/16	456H-0302	436T-0302
–	3.0709	78.00	7/16	456H-78	436T-78
3-3/32	3.0938	78.58	7/16	456H-0303	436T-0303
3-1/8	3.1250	79.38	7/16	456H-0304	436T-0304
–	3.1496	80.00	7/16	456H-80	436T-80
3-5/32	3.1563	80.17	7/16	456H-0305	436T-0305
3-3/16	3.1875	80.96	7/16	456H-0306	436T-0306
3-7/32	3.2188	81.76	7/16	456H-0307	436T-0307
–	3.2283	82.00	7/16	456H-82	436T-82
3-1/4	3.2500	82.55	7/16	456H-0308	436T-0308
3-9/32	3.2813	83.34	7/16	456H-0309	436T-0309
–	3.3071	84.00	7/16	456H-84	436T-84
3-5/16	3.3125	84.14	7/16	456H-0310	436T-0310
3-11/32	3.3438	84.93	7/16	456H-0311	436T-0311
3-3/8	3.3750	85.73	7/16	456H-0312	436T-0312
–	3.3858	86.00	7/16	456H-86	436T-86
3-13/32	3.4063	86.52	7/16	456H-0313	436T-0313
3-7/16	3.4375	87.31	7/16	456H-0314	436T-0314
–	3.4646	88.00	7/16	456H-88	436T-88
3-15/32	3.4688	88.11	7/16	456H-0315	436T-0315
3-1/2	3.5000	88.90	7/16	456H-0316	436T-0316

A  
DRILLINGB  
BORINGC  
REAMINGD  
BURNISHINGE  
THREADINGX  
SPECIALS

Inserts sold in quantities of 1

A30: 112 - 143

A30: 98 - 100

A30: 4 - 6

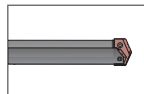
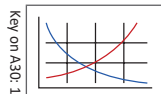

HI, HR, CR, SK,  
BR, NC, WC

Coatings not listed above  
can be supplied as  
non-stocked standards.  
Process fees apply. →

TiN = 456T-XXXX

TiAlN = 456A-XXXX

TiCN = 456N-XXXX

AM200® = 456H-XXXX





**T-A® Drill Inserts**

6 Series | HSS | Diameter Range: 3.001" - 3.507" (76.22 mm - 89.08 mm)

(for use with 5 series holders)

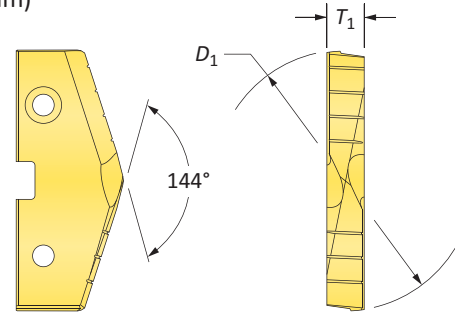

HSS Inserts – Super Cobalt | HSS

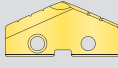
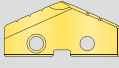
Fractional Equivalent	Insert			Super Cobalt Part No.*	HSS Part No.
	$D_1$ inch	$D_1$ mm	$T_1$	 TiN	 TiN
3-1/32	3.0313	76.99	7/16	156T-0301	136T-0301
3-1/16	3.0625	77.79	7/16	156T-0302	136T-0302
-	3.0709	78.00	7/16	156T-78	136T-78
3-3/32	3.0938	78.58	7/16	156T-0303	136T-0303
3-1/8	3.1250	79.38	7/16	156T-0304	136T-0304
-	3.1496	80.00	7/16	156T-80	136T-80
3-5/32	3.1563	80.17	7/16	156T-0305	136T-0305
3-3/16	3.1875	80.96	7/16	156T-0306	136T-0306
3-7/32	3.2188	81.76	7/16	156T-0307	136T-0307
-	3.2283	82.00	7/16	156T-82	136T-82
3-1/4	3.2500	82.55	7/16	156T-0308	136T-0308
3-9/32	3.2813	83.34	7/16	156T-0309	136T-0309
-	3.3071	84.00	7/16	156T-84	136T-84
3-5/16	3.3125	84.14	7/16	156T-0310	136T-0310
3-11/32	3.3438	84.93	7/16	156T-0311	136T-0311
3-3/8	3.3750	85.73	7/16	156T-0312	136T-0312
-	3.3858	86.00	7/16	156T-86	136T-86
3-13/32	3.4063	86.52	7/16	156T-0313	136T-0313
3-7/16	3.4375	87.31	7/16	156T-0314	136T-0314
-	3.4646	88.00	7/16	156T-88	136T-88
3-15/32	3.4688	88.11	7/16	156T-0315	136T-0315
3-1/2	3.5000	88.90	7/16	156T-0316	136T-0316

\*Available as non-stocked standard

Key on A30-1

A30: 112 - 143

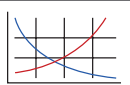

A30: 98 - 100



A30: 4 - 6



HI, HR, CR, SK,  
BR, NC, WC, TC

Coatings not listed above can be supplied as non-stocked standards. Process fees apply. →

TiN = 156T-XXXX	TiAlN = 156A-XXXX
TiCN = 156N-XXXX	AM200® = 156H-XXXX

Inserts sold in quantities of 1

## T-A® Drill Insert Holders

5 Series | Flange Shank | Diameter Range: 2.456" - 3.507" (62.38 mm - 89.08 mm)

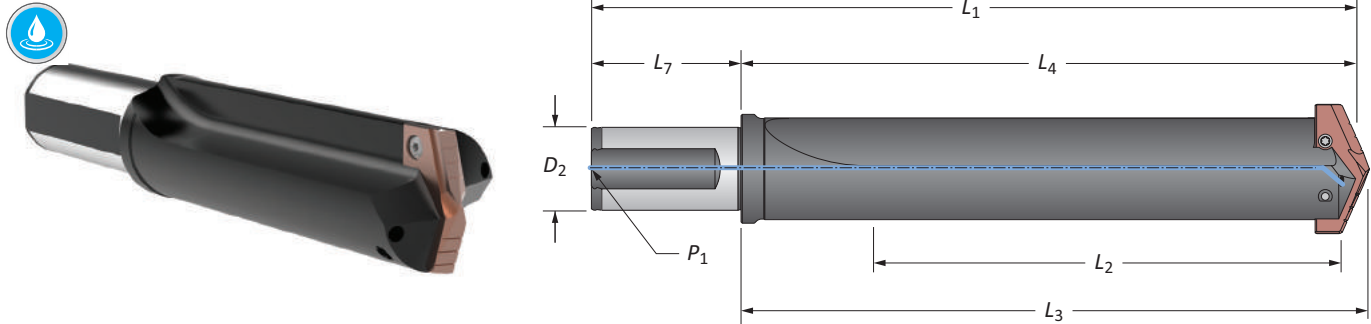

### Straight Flute

Length	Body				Shank			Part No.
	L <sub>2</sub>	L <sub>4</sub>	L <sub>3</sub>	L <sub>1</sub>	D <sub>2</sub>	L <sub>7</sub>	P <sub>1</sub>	
<b>i</b> Short	6-49/64	8-1/2	8-3/4	13-1/4	2	4-1/2	1/2	22050S-200F
Extended	18-17/64	20	20-1/4	24-3/4	2	4-1/2	1/2	25050S-200F
<b>m</b> Short	172	215.9	222.3	302.3	50.0	80.0	1/2*	22050S-50FM
Extended	464	508	514.4	594.4	50.0	80.0	1/2*	25050S-50FM

\*Metric thread to BSP and ISO 7-1

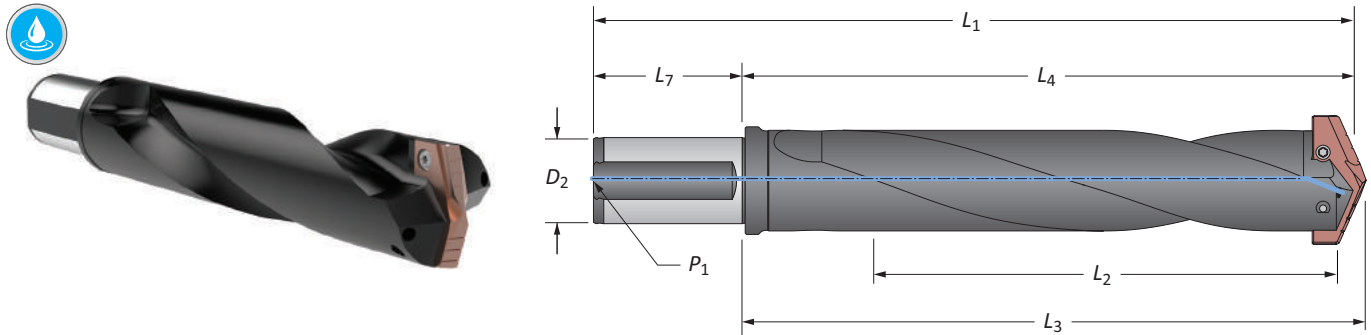

### Helical Flute

Length	Body				Shank			Part No.
	L <sub>2</sub>	L <sub>4</sub>	L <sub>3</sub>	L <sub>1</sub>	D <sub>2</sub>	L <sub>7</sub>	P <sub>1</sub>	
<b>i</b> Standard	10-3/4	12-1/2	12-3/4	17-1/4	2	4-1/2	1/2	24050H-200F
<b>m</b> Standard	273	317.5	323.9	403.9	50.0	80.0	1/2*	24050H-50FM

\*Metric thread to BSP and ISO 7-1

### Connection Accessories

Insert Screws	Nylon Locking Screws	Insert Driver	Preset Torque Hand Driver	Replacement Tips	Admissible Tightening Torque*
7619-IP25-1	-	8IP-25	-	-	155.0 in-lbs (1750 N-cm)

\*Tightening torques are calculated with a friction coefficient of  $\mu = 0.14$  and develop 90% of ultimate yield strength

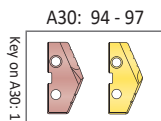

**i** = Imperial (in)  
**m** = Metric (mm)

Screws sold in quantities of 10

**WARNING** Refer to Speed and Feed charts for recommended adjustments to speeds and feeds. Refer to page A30: 146 for deep hole drilling guidelines in this section of the catalog. Visit [www.alliedmachine.com/DeepHoleGuidelines](http://www.alliedmachine.com/DeepHoleGuidelines) for the most up-to-date information and procedures. Factory technical assistance is available for your specific applications through our Application Engineering Team.



## T-A® Drill Insert Holders

5 Series | Taper Shank | Diameter Range: 2.456" - 3.507" (62.38 mm - 89.08 mm)

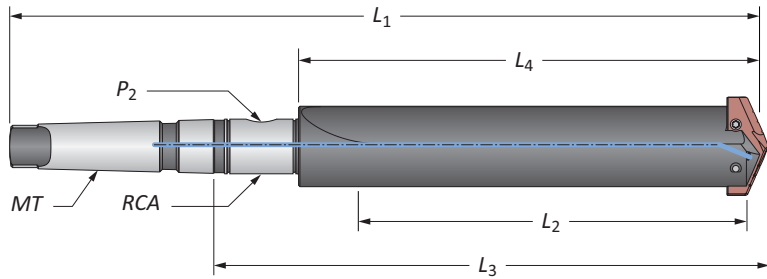

### Straight Flute

	Length	Body				Shank			Part No.
		L <sub>2</sub>	L <sub>4</sub>	L <sub>3</sub>	L <sub>1</sub>	MT	P <sub>2</sub>	RCA	
i	Short	6-3/4	8-1/2	11-5/16	16-15/16	#5	1/2	2T-6SR	22050S-005I
	Standard	10-3/4	12-1/2	15-5/16	20-15/16	#5	1/2	2T-6SR	24050S-005I
	Extended	18-1/4	20	22-13/16	28-7/16	#5	1/2	2T-6SR	25050S-005I
	XL	26	27-3/4	30-9/16	36-3/16	#5	1/2	2T-6SR	27050S-005I
	3XL	35	36-3/4	39-9/16	45-3/16	#5	1/2	2T-6SR	29050S-005I
m	Short	171.5	215.9	287.3	430.2	#5**	1/2*	2T-6SRM	22050S-005M
	Extended	463.6	508.0	579.4	722.3	#5**	1/2*	2T-6SRM	25050S-005M
	XL	660.0	704.8	776.2	919.1	#5**	1/2*	2T-6SRM	27050S-005M
	3XL	889.0	933.4	1004.8	1147.7	#5**	1/2*	2T-6SRM	29050S-005M

\*Metric thread to BSP and ISO 7-1

\*\*Per ISO 296 type BEK

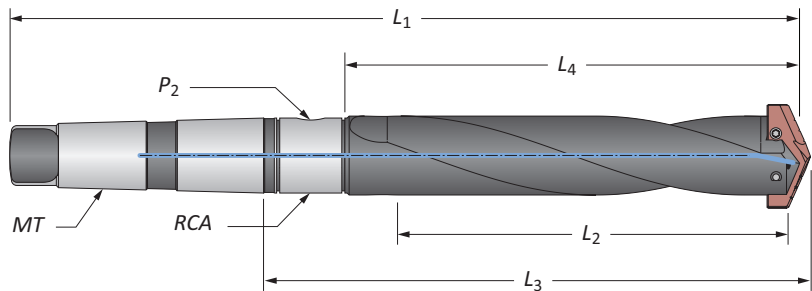

### Helical Flute

	Length	Body				Shank			Part No.
		L <sub>2</sub>	L <sub>4</sub>	L <sub>3</sub>	L <sub>1</sub>	MT	P <sub>2</sub>	RCA	
m	Standard	273.1	317.5	388.9	531.8	#5**	1/2*	2T-6SRM	24050H-005M

\*Metric thread to BSP and ISO 7-1

\*\*Per ISO 296 type BEK

### Connection Accessories

Insert Screws	Nylon Locking Screws	Insert Driver	Preset Torque Hand Driver	Replacement Tips	Admissible Tightening Torque*
7619-IP25-1	-	8IP-25	-	-	155.0 in-lbs (1750 N-cm)

\*Tightening torques are calculated with a friction coefficient of  $\mu = 0.14$  and develop 90% of ultimate yield strength

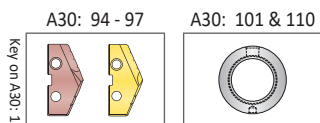

i = Imperial (in)

m = Metric (mm)

Screws sold in quantities of 10

**WARNING** Refer to Speed and Feed charts for recommended adjustments to speeds and feeds. Refer to page A30: 146 for deep hole drilling guidelines in this section of the catalog. Visit [www.alliedmachine.com/DeepHoleGuidelines](http://www.alliedmachine.com/DeepHoleGuidelines) for the most up-to-date information and procedures. Factory technical assistance is available for your specific applications through our Application Engineering Team.

## T-A® Drill Insert Holders

5 Series | Straight Shank | Diameter Range: 2.456" - 3.507" (62.38 mm - 89.08 mm)

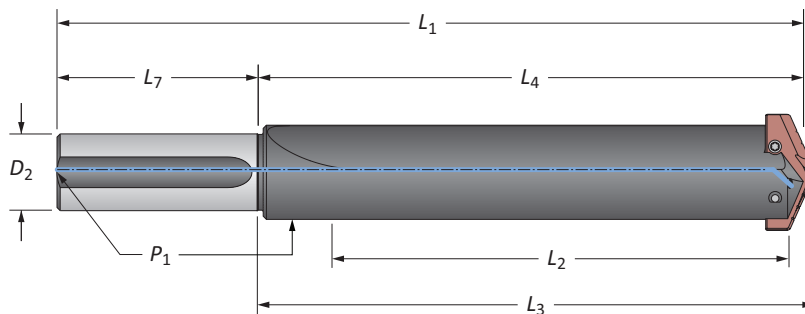

### Straight Flute

Length	Body				Shank			Part No.
	L <sub>2</sub>	L <sub>4</sub>	L <sub>3</sub>	L <sub>1</sub>	D <sub>2</sub>	L <sub>7</sub>	P <sub>1</sub>	
Short	6-3/4	8-1/2	8-3/4	12-1/2	2	4	1/2	22050S-200L
Standard	10-3/4	12-1/2	12-3/4	16-1/2	2	4	1/2	24050S-200L
Extended	18-1/4	20	20-1/4	24	2	4	1/2	25050S-200L
XL	26	27-3/4	28	31-3/4	2	4	1/2	27050S-200L
3XL	35	36-3/4	37	40-3/4	2	4	1/2	29050S-200L

C REAMING

D BURNISHING

F THREADING

### Connection Accessories

Insert Screws	Nylon Locking Screws	Insert Driver	Preset Torque Hand Driver	Replacement Tips	Admissible Tightening Torque*
7619-IP25-1	-	8IP-25	-	-	155.0 in-lbs (1750 N-cm)

\*Tightening torques are calculated with a friction coefficient of  $\mu = 0.14$  and develop 90% of ultimate yield strength

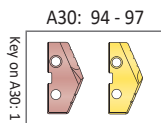

i = Imperial (in)  
m = Metric (mm)

Screws sold in quantities of 10

**WARNING** Refer to Speed and Feed charts for recommended adjustments to speeds and feeds. Refer to page A30: 146 for deep hole drilling guidelines in this section of the catalog. Visit [www.alliedmachine.com/DeepHoleGuidelines](http://www.alliedmachine.com/DeepHoleGuidelines) for the most up-to-date information and procedures. Factory technical assistance is available for your specific applications through our Application Engineering Team.

X SPECIALS



## T-A® Drill Accessories

5/6 Series | Rotary Coolant Adapters | Torx® Plus Screws

### Rotary Coolant Adapter (RCA) and Accessories

ID	OD	L <sub>1</sub>	Driving Rod Thread	P <sub>1</sub>	Part No.	RCA O-Rings	
						Kit Part No.**	Replacements
<b>i</b> 2-1/4	3-3/4	1-3/4	1/2-13	1/2	<b>⚠</b> 2T-6SR	2T1-6SR	2T1-6OR-10
<b>m</b> 57.15	95.27	44.45	M12 x 1.75	1/2*	<b>⚠</b> 2T-6SRM	2T1-6SR	2T1-6OR-10

\*Thread to BSP and ISO 7-1

\*\*RCA Repair Kit includes (2) O-rings, (2) snap rings, and (2) thrust washers

**⚠** Refer to page A30: 110 for proper RCA assembly and safety information

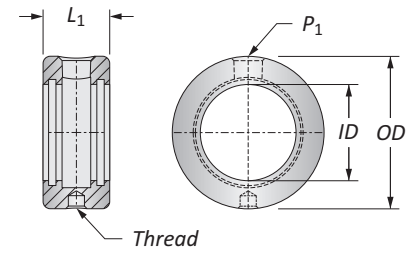

### Connection Accessories

Insert Screws	Nylon Locking Screws	Insert Driver	Preset Torque Hand Driver	Replacement Tips	Admissible Tightening Torque*
7619-IP25-1	-	8IP-25	-	-	155.0 in-lbs (1750 N-cm)

\*Tightening torques are calculated with a friction coefficient of  $\mu = 0.14$  and develop 90% of ultimate yield strength

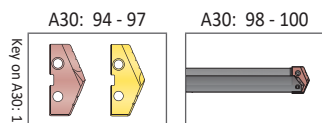

**i** = Imperial (in)  
**m** = Metric (mm)  
 Inserts sold separately  
 Screws sold in packs of 10  
 O-rings sold in packs of 10



**⚠ WARNING** Refer to Speed and Feed charts for recommended adjustments to speeds and feeds. Refer to page A30: 146 for deep hole drilling guidelines in this section of the catalog. Visit [www.alliedmachine.com/DeepHoleGuidelines](http://www.alliedmachine.com/DeepHoleGuidelines) for the most up-to-date information and procedures. Factory technical assistance is available for your specific applications through our Application Engineering Team.

## GEN2 T-A® Drill Inserts

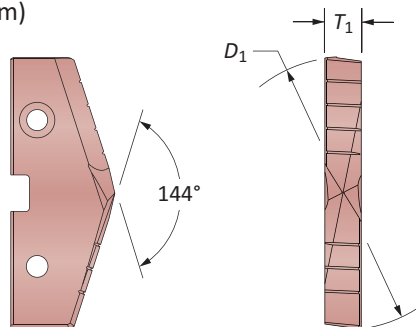
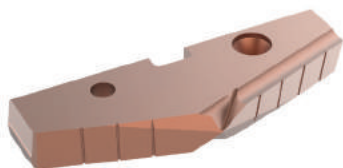
7 Series | HSS | Diameter Range: 3.508" - 4.000" (89.10 mm - 101.60 mm)

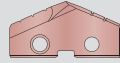

HSS Inserts – Super Cobalt | HSS

Fractional Equivalent	Insert			Super Cobalt Part No.	HSS Part No.
	$D_1$ inch	$D_1$ mm	$T_1$	 AM200®	 TiN
3-17/32	3.5313	89.69	7/16	457H-0317	437T-0317
–	3.5433	90.00	7/16	457H-90	437T-90
3-9/16	3.5625	90.49	7/16	457H-0318	437T-0318
3-19/32	3.5938	91.28	7/16	457H-0319	437T-0319
–	3.6221	92.00	7/16	457H-92	437T-92
3-5/8	3.6250	92.08	7/16	457H-0320	437T-0320
3-21/32	3.6563	92.87	7/16	457H-0321	437T-0321
3-11/16	3.6875	93.66	7/16	457H-0322	437T-0322
–	3.7008	94.00	7/16	457H-94	437T-94
3-23/32	3.7188	94.46	7/16	457H-0323	437T-0323
3-3/4	3.7500	95.25	7/16	457H-0324	437T-0324
–	3.7795	96.00	7/16	457H-96	437T-96
3-25/32	3.7813	96.04	7/16	457H-0325	437T-0325
3-13/16	3.8125	96.84	7/16	457H-0326	437T-0326
3-27/32	3.8438	97.63	7/16	457H-0327	437T-0327
–	3.8583	98.00	7/16	457H-98	437T-98
3-7/8	3.8750	98.43	7/16	457H-0328	437T-0328
3-29/32	3.9063	99.22	7/16	457H-0329	437T-0329
–	3.9370	100.00	7/16	457H-100	437T-100
3-15/16	3.9375	100.01	7/16	457H-0330	437T-0330
3-31/32	3.9688	100.81	7/16	457H-0331	437T-0331
4	4.0000	101.60	7/16	457H-0400	437T-0400

D BURNISHING

F THREADING

X SPECIALS

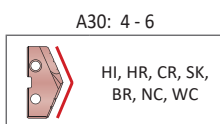
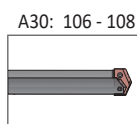
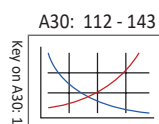

Coatings not listed above  
can be supplied as  
non-stocked standards.  
Process fees apply. →

TiN = 457T-XXXX	TiAlN = 457A-XXXX
TiCN = 457N-XXXX	AM200® = 457H-XXXX

Inserts sold in quantities of 1



T-A® Drill Inserts

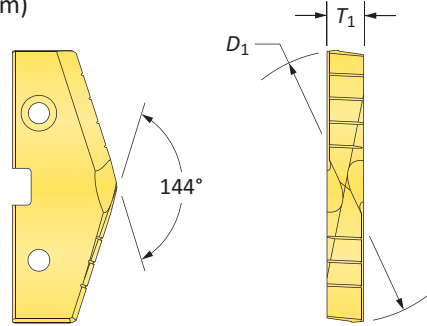

7 Series | HSS | Diameter Range: 3.508" - 4.000" (89.10 mm - 101.60 mm)

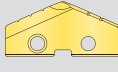
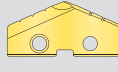

HSS Inserts – Super Cobalt | HSS

Fractional Equivalent	Insert			Super Cobalt Part No.*	HSS Part No.
	D <sub>1</sub> inch	D <sub>1</sub> mm	T <sub>1</sub>	 TiN	 TiN
3-17/32	3.5313	89.69	7/16	157T-0317	137T-0317
-	3.5433	90.00	7/16	157T-90	137T-90
3-9/16	3.5625	90.49	7/16	157T-0318	137T-0318
3-19/32	3.5938	91.28	7/16	157T-0319	137T-0319
-	3.6221	92.00	7/16	157T-92	137T-92
3-5/8	3.6250	92.08	7/16	157T-0320	137T-0320
3-21/32	3.6563	92.87	7/16	157T-0321	137T-0321
3-11/16	3.6875	93.66	7/16	157T-0322	137T-0322
-	3.7008	94.00	7/16	157T-94	137T-94
3-23/32	3.7188	94.46	7/16	157T-0323	137T-0323
3-3/4	3.7500	95.25	7/16	157T-0324	137T-0324
-	3.7795	96.00	7/16	157T-96	137T-96
3-25/32	3.7813	96.04	7/16	157T-0325	137T-0325
3-13/16	3.8125	96.84	7/16	157T-0326	137T-0326
3-27/32	3.8438	97.63	7/16	157T-0327	137T-0327
-	3.8583	98.00	7/16	157T-98	137T-98
3-7/8	3.8750	98.43	7/16	157T-0328	137T-0328
3-29/32	3.9063	99.22	7/16	157T-0329	137T-0329
-	3.9370	100.00	7/16	157T-100	137T-100
3-15/16	3.9375	100.01	7/16	157T-0330	137T-0330
3-31/32	3.9688	100.81	7/16	157T-0331	137T-0331
4	4.0000	101.60	7/16	157T-0400	137T-0400

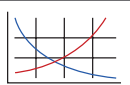
\*Available as non-stocked standard

A30: 112 - 143  A30: 106 - 108  A30: 4 - 6  HI, HR, CR, SK, BR, NC, WC, TC

Coatings not listed above can be supplied as non-stocked standards. Process fees apply. →

TiN = 157T-XXXX	TiAlN = 157A-XXXX
TiCN = 157N-XXXX	AM200® = 157H-XXXX

Inserts sold in quantities of 1

A DRILLING  
B BORING  
C REAMING  
D BURNISHING  
E THREADING  
X SPECIALS



## GEN2 T-A® Drill Inserts

8 Series | HSS | Diameter Range: 4.001" - 4.507" (101.63 mm - 114.48 mm)

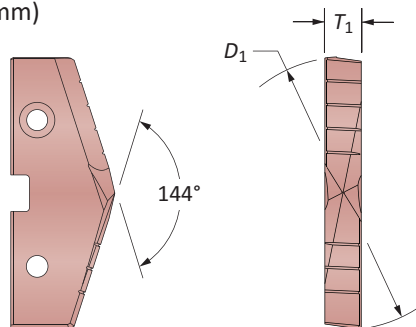
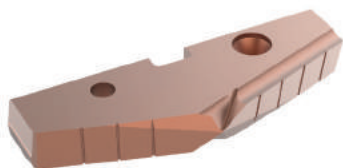
(for use with 7 series holders)

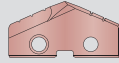

HSS Inserts – Super Cobalt | HSS

Fractional Equivalent	Insert			Super Cobalt Part No.	HSS Part No.
	$D_1$ inch	$D_1$ mm	$T_1$	 AM200®	 TiN
4-1/64	4.0157	102.00	7/16	458H-102	438T-102
4-1/16	4.0625	103.19	7/16	458H-0402	438T-0402
4-3/32	4.0945	104.00	7/16	458H-104	438T-104
4-1/8	4.1250	104.75	7/16	458H-0404	438T-0404
–	4.1732	106.00	7/16	458H-106	438T-106
4-3/16	4.1875	106.36	7/16	458H-0406	438T-0406
4-1/4	4.2500	107.95	7/16	458H-0408	438T-0408
–	4.2520	108.00	7/16	458H-108	438T-108
4-5/16	4.3125	109.54	7/16	458H-0410	438T-0410
–	4.3307	110.00	7/16	458H-110	438T-110
4-3/8	4.3750	111.13	7/16	458H-0412	438T-0412
–	4.4094	112.00	7/16	458H-112	438T-112
4-7/16	4.4375	112.71	7/16	458H-0414	438T-0414
–	4.4882	114.00	7/16	458H-114	438T-114
4-1/2	4.5000	114.30	7/16	458H-0416	438T-0416

D

BURNISHING

F

THREADING

X

SPECIALS

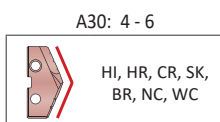
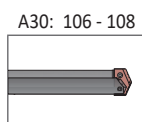
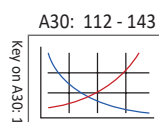

Coatings not listed above  
can be supplied as  
non-stocked standards.  
Process fees apply. →

TiN = 458T-XXXX	TiAlN = 458A-XXXX
TiCN = 458N-XXXX	AM200® = 458H-XXXX

Inserts sold in quantities of 1







### T-A® Drill Inserts

8 Series | HSS | Diameter Range: 4.001" - 4.507" (101.63 mm - 114.48 mm)

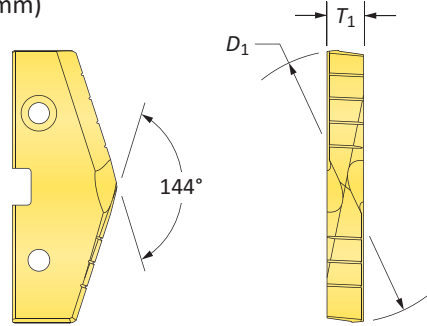
(for use with 7 series holders)

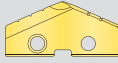

#### HSS Inserts – Super Cobalt | HSS

Fractional Equivalent	Insert			Super Cobalt Part No.*	HSS Part No.
	$D_1$ inch	$D_1$ mm	$T_1$	 TiN	 TiN
4-1/64	4.0157	102.00	7/16	158T-102	138T-102
4-1/16	4.0625	103.19	7/16	158T-0402	138T-0402
4-3/32	4.0945	104.00	7/16	158T-104	138T-104
4-1/8	4.1250	104.75	7/16	158T-0404	138T-0404
-	4.1732	106.00	7/16	158T-106	138T-106
4-3/16	4.1875	106.36	7/16	158T-0406	138T-0406
4-1/4	4.2500	107.95	7/16	158T-0408	138T-0408
-	4.2520	108.00	7/16	158T-108	138T-108
4-5/16	4.3125	109.54	7/16	158T-0410	138T-0410
-	4.3307	110.00	7/16	158T-110	138T-110
4-3/8	4.3750	111.13	7/16	158T-0412	138T-0412
-	4.4094	112.00	7/16	158T-112	138T-112
4-7/16	4.4375	112.71	7/16	158T-0414	138T-0414
-	4.4882	114.00	7/16	158T-114	138T-114
4-1/2	4.5000	114.30	7/16	158T-0416	138T-0416

\*Available as non-stocked standard

A30: 112 - 143

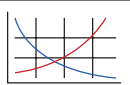

A30: 106 - 108



A30: 4 - 6



HI, HR, CR, SK,  
BR, NC, WC, TC

Coatings not listed above can be supplied as non-stocked standards. Process fees apply. →

TiN = 158T-XXXX	TiAlN = 158A-XXXX
TiCN = 158N-XXXX	AM200® = 158H-XXXX

Inserts sold in quantities of 1

## T-A® Drill Insert Holders

7 Series | Flange Shank | Diameter Range: 3.5080" - 4.507" (89.10 mm - 101.60 mm)

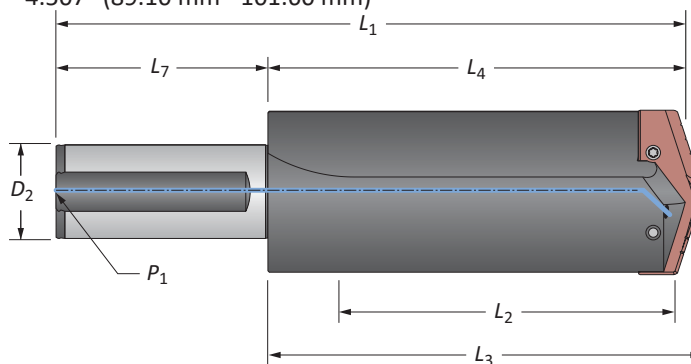

### Straight Flute

Length	Body				Shank			Part No.
	$L_2$	$L_4$	$L_3$	$L_1$	$D_2$	$L_7$	$P_1$	
<b>i</b> Short	6-49/64	8-7/8	9-1/8	13-5/8	2	4-1/2	1/2	22070S-200F
Extended	21-57/64	23-57/64	24-1/4	27-3/4	2	4-1/2	1/2	<b>25070S-200F</b>
<b>m</b> Short	172	225.4	231.8	311.8	50.0	80.0	1/2*	22070S-50FM
Extended	556	606.9	616	696	50.0	80.0	1/2*	<b>25070S-50FM</b>

\*Metric thread to BSP and ISO 7-1

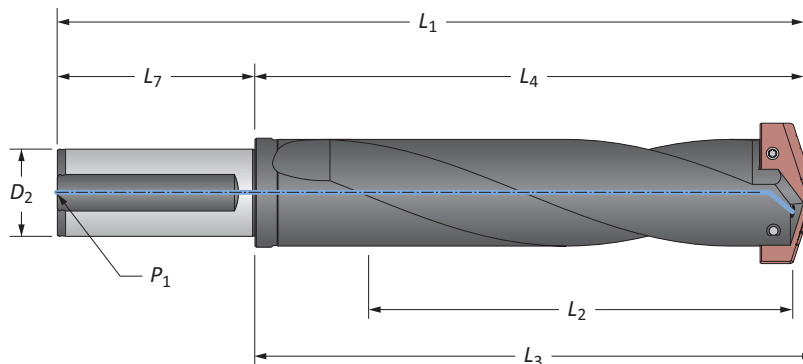

### Helical Flute

Length	Body				Shank			Part No.
	$L_2$	$L_4$	$L_3$	$L_1$	$D_2$	$L_7$	$P_1$	
<b>i</b> Standard	10-3/4	12-7/8	13-1/8	17-5/8	2	4-1/2	1/2	24070H-200F
<b>m</b> Standard	273	327	333.4	413.4	50.0	80.0	1/2*	24070H-50FM

\*Metric thread to BSP and ISO 7-1

### Connection Accessories

Insert Screws	Nylon Locking Screws	Insert Driver	Preset Torque Hand Driver	Replacement Tips	Admissible Tightening Torque*
7619-IP25-1	-	8IP-25	-	-	155.0 in-lbs (1750 N-cm)

\*Tightening torques are calculated with a friction coefficient of  $\mu = 0.14$  and develop 90% of ultimate yield strength

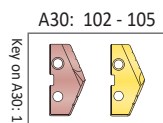

**i** = Imperial (in)

**m** = Metric (mm)

Screws sold in quantities of 10

**WARNING** Refer to Speed and Feed charts for recommended adjustments to speeds and feeds. Refer to page A30: 146 for deep hole drilling guidelines in this section of the catalog. Visit [www.alliedmachine.com/DeepHoleGuidelines](http://www.alliedmachine.com/DeepHoleGuidelines) for the most up-to-date information and procedures. Factory technical assistance is available for your specific applications through our Application Engineering Team.

## T-A® Drill Insert Holders

7 Series | Taper Shank | Diameter Range: 3.508" - 4.507" (89.10 mm - 101.60 mm)

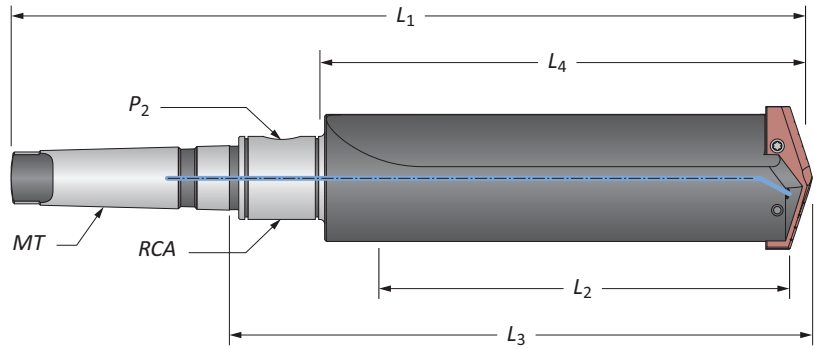

### Straight Flute

	Body				Shank			Part No.	
	Length	L <sub>2</sub>	L <sub>4</sub>	L <sub>3</sub>	L <sub>1</sub>	MT	P <sub>2</sub>		RCA
i	Short	6-3/4	8-7/8	11-11/16	17-5/16	#5	1/2	2T-6SR	22070S-005I
	Standard	10-3/4	12-7/8	15-11/16	21-5/16	#5	1/2	2T-6SR	24070S-005I
	Extended	21-7/8	24	26-13/16	32-7/16	#5	1/2	2T-6SR	▲ 25070S-005I
	XL	27	29-1/8	31-15/16	37-9/16	#5	1/2	2T-6SR	▲ 27070S-005I
	3XL	37	39-1/8	41-5/16	47-9/16	#5	1/2	2T-6SR	▲ 29070S-005I
m	Short	171.5	225.4	296.8	439.7	#5**	1/2*	2T-6SRM	22070S-005M
	Extended	555.6	609.6	681.1	823.9	#5**	1/2*	2T-6SRM	▲ 25070S-005M
	XL	685.0	739.7	811.2	954.0	#5**	1/2*	2T-6SRM	▲ 27070S-005M
	3XL	939.0	993.7	1065.2	1208.0	#5**	1/2*	2T-6SRM	▲ 29070S-005M

\*Metric thread to BSP and ISO 7-1

\*\*Per ISO 296 type BEK

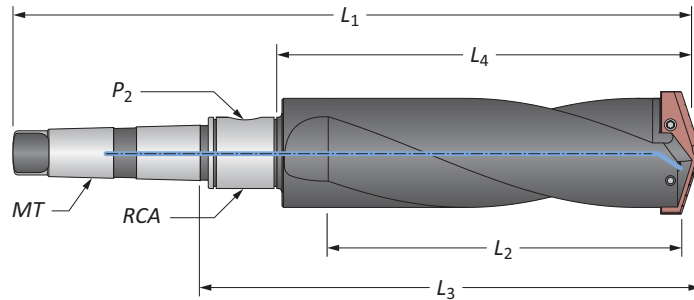

### Helical Flute

	Body				Shank			Part No.	
	Length	L <sub>2</sub>	L <sub>4</sub>	L <sub>3</sub>	L <sub>1</sub>	MT	P <sub>2</sub>		RCA
m	Standard	273.1	327.0	398.5	541.3	#5**	1/2*	2T-6SRM	24070H-005M

\*Metric thread to BSP and ISO 7-1

\*\*Per ISO 296 type BEK

### Connection Accessories

Insert Screws	Nylon Locking Screws	Insert Driver	Preset Torque Hand Driver	Replacement Tips	Admissible Tightening Torque*
7619-IP25-1	-	8IP-25	-	-	155.0 in-lbs (1750 N-cm)

\*Tightening torques are calculated with a friction coefficient of  $\mu = 0.14$  and develop 90% of ultimate yield strength

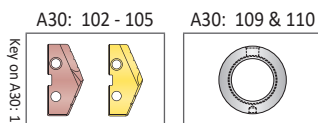

i = Imperial (in)

m = Metric (mm)

Screws sold in quantities of 10

**WARNING** Refer to Speed and Feed charts for recommended adjustments to speeds and feeds. Refer to page A30: 146 for deep hole drilling guidelines in this section of the catalog. Visit [www.alliedmachine.com/DeepHoleGuidelines](http://www.alliedmachine.com/DeepHoleGuidelines) for the most up-to-date information and procedures. Factory technical assistance is available for your specific applications through our Application Engineering Team.

## T-A® Drill Insert Holders

7 Series | Straight Shank | Diameter Range: 3.508" - 4.507" (89.10 mm - 101.60 mm)

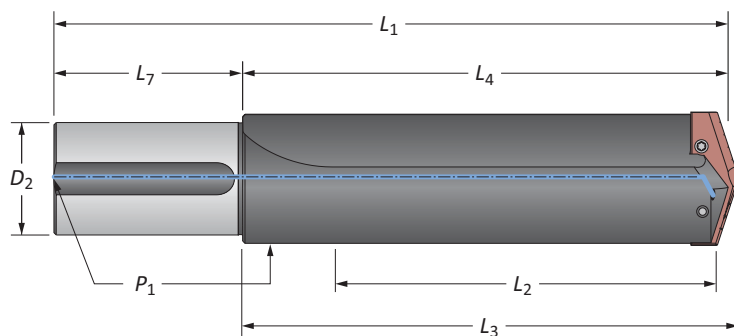

### Straight Flute

Length	Body				Shank			Part No.
	$L_2$	$L_4$	$L_3$	$L_1$	$D_2$	$L_7$	$P_1$	
Short	6-3/4	8-7/8	9-1/8	13-7/8	3	5	1/2	22070S-300L
Standard	10-3/4	12-7/8	13-1/8	17-7/8	3	5	1/2	24070S-300L
<b>i</b> Extended	21-7/8	24	24-1/4	29	3	5	1/2	<b>m</b> 25070S-300L
XL	27	29-1/8	29-3/8	34-1/8	3	5	1/2	<b>m</b> 27070S-300L
3XL	37	39-1/8	39-3/8	44-1/8	3	5	1/2	<b>m</b> 29070S-300L

### Connection Accessories

Insert Screws	Nylon Locking Screws	Insert Driver	Preset Torque Hand Driver	Replacement Tips	Admissible Tightening Torque*
7619-IP25-1	-	8IP-25	-	-	155.0 in-lbs (1750 N-cm)

\*Tightening torques are calculated with a friction coefficient of  $\mu = 0.14$  and develop 90% of ultimate yield strength

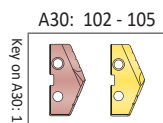

**i** = Imperial (in)

**m** = Metric (mm)

Screws sold in quantities of 10

**WARNING** Refer to Speed and Feed charts for recommended adjustments to speeds and feeds. Refer to page A30: 146 for deep hole drilling guidelines in this section of the catalog. Visit [www.alliedmachine.com/DeepHoleGuidelines](http://www.alliedmachine.com/DeepHoleGuidelines) for the most up-to-date information and procedures. Factory technical assistance is available for your specific applications through our Application Engineering Team.



T-A® Drill Accessories

7/8 Series | Rotary Coolant Adapters | Torx® Plus Screws

Rotary Coolant Adapter (RCA) and Accessories

ID	OD	L <sub>1</sub>	Driving Rod Thread	P <sub>1</sub>	Part No.	RCA O-Rings	
						Kit Part No.**	Replacements
<b>i</b> 2-1/4	3-3/4	1-3/4	1/2-13	1/2	<b>⚠</b> 2T-6SR	2T1-6SR	2T1-6OR-10
<b>m</b> 57.15	95.27	44.45	M12 x 1.75	1/2*	<b>⚠</b> 2T-6SRM	2T1-6SR	2T1-6OR-10

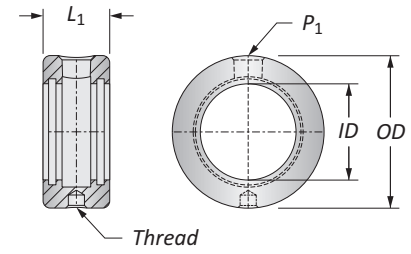

\*Thread to BSP and ISO 7-1

\*\*RCA Repair Kit includes (2) O-rings, (2) snap rings, and (2) thrust washers

**⚠** Refer to page A30: 110 for proper RCA assembly and safety information

Connection Accessories

Insert Screws	Nylon Locking Screws	Insert Driver	Preset Torque Hand Driver	Replacement Tips	Admissible Tightening Torque*
7619-IP25-1	-	8IP-25	-	-	155.0 in-lbs (1750 N-cm)

\*Tightening torques are calculated with a friction coefficient of  $\mu = 0.14$  and develop 90% of ultimate yield strength

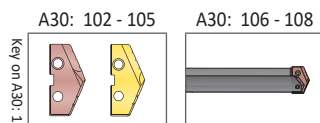

**i** = Imperial (in)  
**m** = Metric (mm)

Inserts sold separately  
Screws sold in packs of 10  
O-rings sold in packs of 10

**⚠ WARNING** Refer to Speed and Feed charts for recommended adjustments to speeds and feeds. Refer to page A30: 146 for deep hole drilling guidelines in this section of the catalog. Visit [www.alliedmachine.com/DeepHoleGuidelines](http://www.alliedmachine.com/DeepHoleGuidelines) for the most up-to-date information and procedures. Factory technical assistance is available for your specific applications through our Application Engineering Team.

A  
DRILLING  
B  
BORING  
C  
REAMING  
D  
BURNISHING  
E  
THREADING  
X  
SPECIALS

## Rotary Coolant Adapters (RCA)

### Morse Taper Shanks

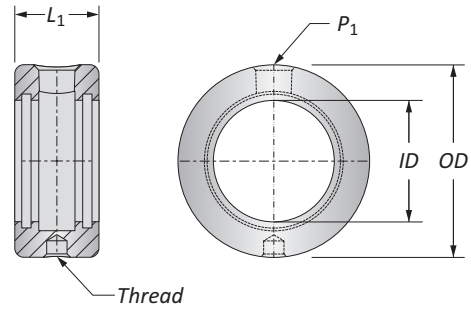

Holder Series	ID	OD	L <sub>1</sub>	Driving Rod Thread	P <sub>1</sub>	Part No.	Max Recommended RPM	RCA O-Rings		
								Kit Part No.**	Replacements	
i	Y, Z, 0	3/4	1-3/4	7/8	5/16 - 18	1/8	⚠ 2T-2SR	3500	2T1-2SR	2T1-2OR-10
	1, 2	1	2-1/8	1-1/8	5/16 - 18	1/8	⚠ 2T-3SR	2500	2T1-3SR	2T1-3OR-10
	2, 3, 4	1-1/4	2-1/2	1-3/8	3/8 - 16	1/4	⚠ 2T-4SR	2000	2T1-4SR	2T1-4OR-10
	3, 4	1-3/4	3	1-3/8	3/8 - 16	1/4	⚠ 2T-5SR	1500	2T1-5SR	2T1-5OR-10
	5, 7	2-1/4	3-3/4	1-3/4	1/2 - 13	1/2	⚠ 2T-6SR	1100	2T1-6SR	2T1-6OR-10
m	Y, Z, 0	19.05	44.45	22.23	M8 x 1.25	1/8*	⚠ 2T-2SRM	3500	2T1-2SR	2T1-2OR-10
	1, 2	25.40	53.97	28.57	M8 x 1.25	1/8*	⚠ 2T-3SRM	2500	2T1-3SR	2T1-3OR-10
	2, 3, 4	31.75	63.50	34.92	M10 x 1.50	1/4*	⚠ 2T-4SRM	2000	2T1-4SR	2T1-4OR-10
	3, 4	44.45	76.20	34.92	M10 x 1.50	1/4*	⚠ 2T-5SRM	1500	2T1-5SR	2T1-5OR-10
	5, 7	57.15	95.27	44.45	M12 x 1.75	1/2*	⚠ 2T-6SRM	1100	2T1-6SR	2T1-6OR-10

\*Thread to BSP and ISO 7-1

\*\*RCA Repair Kit includes (2) O-rings, (2) snap rings, and (2) thrust washers

**NOTE:** Max recommended pressure is 600 PSI (42 bar)

**NOTE:** Recommendations above are based on water and oil based coolants

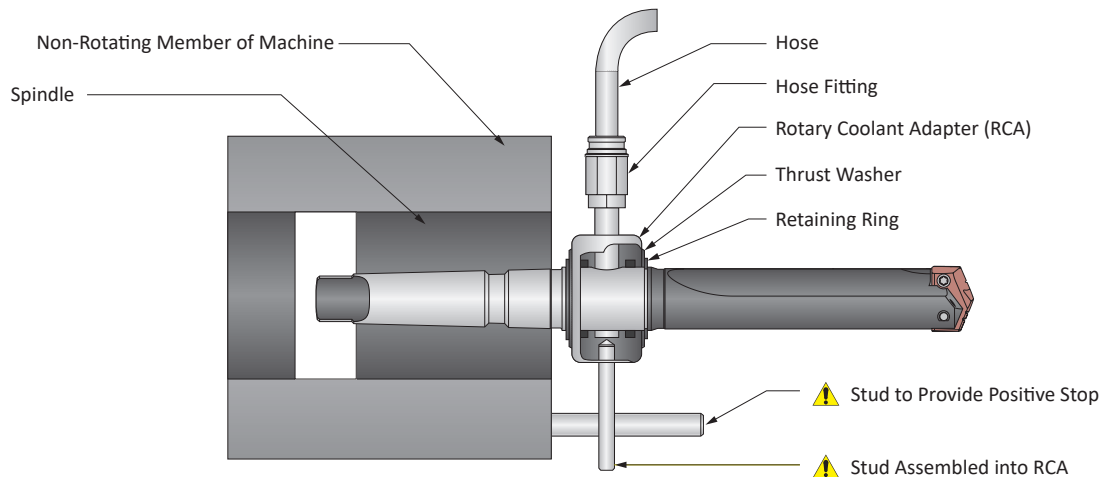

i = Imperial (in)

m = Metric (mm)



O-rings sold in packs of 10

**⚠ WARNING** RCA rotation during drilling can cause hose and/or hose fitting failure, machinery damage, and/or serious injury. To prevent, use RCA and positive stop studs when drilling. Factory technical assistance is also available for your specific applications.

## T-ACR 45 Chamfer Rings

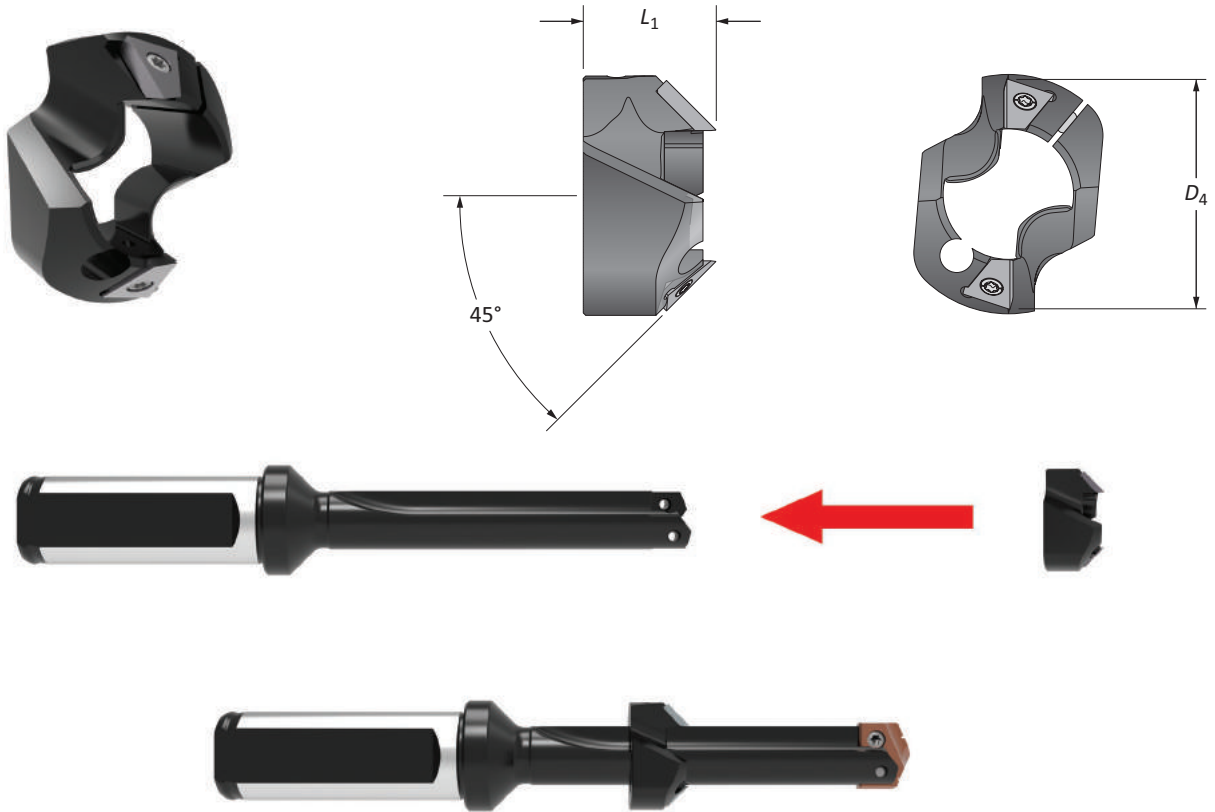
Straight Flute Holders



Holder Series	D <sub>1</sub> Range	Chamfer Ring		Part No.	 Insert Part No.	 Insert Screw	Insert Driver	 Clamping Screw	Insert Driver
		D <sub>4</sub>	L <sub>1</sub>						
0	0.5118 - 0.6890	13/16	0.676	<b>T-ACR-45-0</b>	T-ACRI-45-B-C5A	7255-IP8-1	8IP-8	7375-IP9-1	8IP-9
1	0.6900 - 0.9600	1-3/64	51/64	<b>T-ACR-45-1</b>	T-ACRI-45-B-C5A	7255-IP8-1	8IP-8	7495-IP15-1	8IP-15
1.5	0.8540 - 0.9600	1-1/8	57/64	<b>T-ACR-45-1.5</b>	T-ACRI-45-B-C5A	7255-IP8-1	8IP-8	7495-IP15-1	8IP-15
2	0.9610 - 1.3800	1-9/16	1	<b>T-ACR-45-2</b>	T-ACRI-45-B-C5A	7255-IP8-1	8IP-8	7514-IP20-1	8IP-20

### Highlights and Other Information

- Produces a 45° chamfer only
- Clamping screw allows for setting at any length along the flute
- Double effective cutting with face mounted inserts provides increased feed rates and greater insert strength
- The ring is balanced to match the holder center of gravity to ensure stability
- Inserts only available in C5 carbide and TiAlN coating
- Ideal for short-run or time-sensitive jobs that require quick delivery





**IMPORTANT:** T-A chamfer rings can only be used with straight flute T-A holders

Inserts sold in quantities of 2  
Screws sold in quantities of 10

## GEN2 T-A® Recommended Drilling Data | Imperial (inch)

### HSS Inserts

ISO	Material	Hardness (BHN)	HSS Grade	SFM		Feed Rate (IPR) by Diameter	
				 TiN	 AM200®	3/8" - 1/2"	33/64" - 11/16"
P	Free-Machining Steel 1118, 1215, 12L14, etc.	100 - 150	HSS	200	325	0.008	0.012
		150 - 200	HSS	180	300	0.007	0.011
		200 - 250	HSS	160	280	0.006	0.010
	Low-Carbon Steel 1010, 1020, 1025, 1522, 1144, etc.	85 - 125	HSS	170	290	0.008 ❖	0.010
		125 - 175	HSS	160	275	0.007 ❖	0.010
		175 - 225	HSS	150	260	0.006 ❖	0.009
	Medium-Carbon Steel 1030, 1040, 1050, 1527, 1140, 1151, etc.	225 - 275	HSS	140	240	0.005 ❖	0.009
		125 - 175	HSS	160	275	0.007	0.010
		175 - 225	HSS	150	260	0.006	0.009
	Alloy Steel 4140, 5140, 8640, etc.	225 - 275	HSS	140	240	0.006	0.009
		275 - 325	SC	130	225	0.005	0.008
		275 - 325	SC	120	195	0.005	0.008
325 - 375		SC	110	180	0.004	0.007	
High-Strength Alloy 4340, 4330V, 300M, etc.	225 - 300	SC	80	125	0.006 ❖	0.009	
	300 - 350	SC	60	100	0.005 ❖	0.008	
	350 - 400	SC	50	80	0.004 ❖	0.007	
Structural Steel A36, A285, A516, etc.	100 - 150	HSS	140	235	0.008 ❖	0.011	
	150 - 250	HSS	120	190	0.006 ❖	0.010	
	250 - 350	SC	100	160	0.005 ❖	0.009	
Tool Steel H-13, H-21, A-4, O-2, S-3, etc.	150 - 200	SC	80	125	0.004	0.007	
	200 - 250	SC	60	105	0.004	0.007	
S	High-Temp Alloy Hastelloy B, Inconel 600, etc.	140 - 220	SC	30	45	0.004 ❖	0.007
		220 - 310	SC	25	40	0.004 ❖	0.006
	Titanium Alloy	140 - 220	SC	35	55	0.004 ❖	0.007
		220 - 310	SC	30	50	0.003 ❖	0.006
Aerospace Alloy S82	185 - 275	SC	75	110	0.006 ❖	0.008	
	275 - 350	SC	60	100	0.005 ❖	0.007	
M	Stainless Steel 400 Series 416, 420, etc.	185 - 275	SC	75	110	0.006 ❖	0.008
		275 - 350	SC	60	100	0.005 ❖	0.007
	Stainless Steel 300 Series 304, 316, 17-4PH, etc.	135 - 185	SC	75	110	0.003 ❖	0.007
		185 - 275	SC	60	100	0.003 ❖	0.006
	Super Duplex Stainless Steel	135 - 185	SC	60	85	0.003 ❖	0.007
185 - 275		SC	50	70	0.003 ❖	0.006	
H	Wear Plate Hardox®, AR400, T-1, etc.	400	SC	45	70	0.003 ❖	0.006
		500	SC	35	45	0.002 ❖	0.005
		600	-	-	-	0.004 ❖	0.006
	Hardened Steel	300 - 400	SC	50	95	-	-
400 - 500		SC	35	45	0.002 ❖	0.005	
K	Nodular, Grey, Ductile Cast Iron	120 - 150	HSS	170	290	0.008	0.012
		150 - 200	HSS	150	260	0.007	0.011
		200 - 220	HSS	130	225	0.006	0.009
		220 - 260	SC	110	190	0.005	0.008
		260 - 320	SC	90	155	0.005	0.007
N	Cast Aluminum	30	HSS	600	-	0.009	0.015
		180	HSS	300	-	0.008	0.013
	Wrought Aluminum	30	HSS	600	900	0.005	0.013
		180	HSS	300	650	0.005	0.007
	Aluminum Bronze	100 - 200	SC	170	270	0.006	0.009
		200 - 250	SC	130	210	0.005	0.007
	Brass	100	HSS	300	470	0.007	0.011
Copper	60	SC	130	190	0.003 ❖	0.004	

❖ Contact our Application Engineering department for assistance when machining these materials

**IMPORTANT:** The speeds and feeds listed above are a general starting point for all applications. Refer to the Coolant Recommendation charts for coolant requirements to run at the recommended speeds and feeds. Factory technical assistance is available through our Application Engineering department. See adjustment examples on the following page.



Feed Rate (IPR) by Diameter				
45/64" - 15/16"	31/32" - 1-3/8"	1-13/32" - 1-7/8"	1-29/32" - 2-9/16"	2-19/32" - 4-1/2"
0.016	0.019	0.020	0.023	0.028
0.015	0.017	0.020	0.023	0.028
0.014	0.016	0.020	0.023	0.028
0.014	0.018	0.019	0.023	0.027
0.014	0.017	0.019	0.023	0.027
0.013	0.016	0.018	0.021	0.024
0.013	0.016	0.018	0.021	0.024
0.014	0.017	0.019	0.023	0.027
0.013	0.016	0.018	0.021	0.024
0.013	0.016	0.018	0.021	0.024
0.012	0.015	0.016	0.019	0.022
0.014	0.017	0.017	0.019	0.022
0.013	0.016	0.017	0.019	0.022
0.013	0.016	0.017	0.019	0.022
0.012	0.015	0.015	0.017	0.020
0.011	0.014	0.015	0.017	0.020
0.011	0.013	0.014	0.017	0.020
0.010	0.012	0.014	0.017	0.020
0.009	0.011	0.012	0.015	0.018
0.015	0.017	0.018	0.021	0.026
0.013	0.015	0.016	0.019	0.024
0.012	0.013	0.014	0.017	0.020
0.010	0.012	0.012	0.015	0.017
0.010	0.012	0.012	0.015	0.017
0.009	0.011	0.012	0.015	0.017
0.008	0.010	0.010	0.012	0.014
0.008	0.010	0.012	0.015	0.017
0.007	0.009	0.010	0.012	0.014
0.009	0.011	0.014	0.016	0.020
0.008	0.010	0.012	0.014	0.018
0.009	0.011	0.014	0.016	0.020
0.008	0.010	0.012	0.014	0.018
0.009	0.011	0.014	0.016	0.020
0.008	0.010	0.012	0.014	0.018
0.009	0.011	0.012	0.016	0.018
0.007	0.009	0.010	0.012	0.016
0.016	0.020	0.024	0.027	0.030
0.015	0.019	0.022	0.025	0.028
0.013	0.017	0.018	0.021	0.024
0.011	0.014	0.014	0.017	0.020
0.010	0.012	0.012	0.014	0.016
0.018	0.023	0.022	0.025	0.025
0.016	0.020	0.022	0.025	0.025
0.016	0.020	0.022	0.025	0.025
0.012	0.014	0.022	0.025	0.025
0.012	0.015	0.017	0.019	0.021
0.009	0.011	0.014	0.016	0.018
0.013	0.018	0.019	0.021	0.023
0.007	0.010	0.009	0.011	0.012

**Deep Hole Drilling Speed and Feed Adjustment**

	Holder Length				
	Extended	Long	Long Plus	XL	3XL
Speed	0.90	0.85	0.80	0.80	0.75
Feed	-	0.95	0.90	0.90	0.90

**Recommended Speed and Feed Example**

If the recommended speed and feed is 200 SFM and 0.008 IPR for a standard length holder, then the speed and feed using a 3XL holder in the same application would be 150 SFM and 0.007 IPR.

$200 \cdot 0.75 = 150 \text{ SFM}$        $0.008 \cdot 0.90 = 0.007 \text{ IPR}$

**Formulas**

- RPM = (3.82 • SFM) / DIA**

where:

  - RPM = revolutions per minute (rev/min)
  - SFM = speed (ft/min)
  - DIA = diameter of drill (inch)
- IPM = RPM • IPR**

where:

  - IPM = inches per minute (in/min)
  - RPM = revolutions per minute (rev/min)
  - IPR = feed rate (in/rev)
- SFM = RPM • 0.262 • DIA**

where:

  - SFM = speed (ft/min)
  - RPM = revolutions per minute (rev/min)
  - DIA = diameter of drill (inch)

**⚠ WARNING Tool failure can cause serious injury. To prevent:**

- When using holders without support bushing, use a short T-A® holder to establish an initial hole that is a minimum of 2 diameters deep.
- Do not rotate tool holder more than 50 RPM unless it is engaged with the workpiece or fixture.

Visit [www.alliedmachine.com/DeepHoleGuidelines](http://www.alliedmachine.com/DeepHoleGuidelines) for the most up-to-date information and procedures. Factory technical assistance is available for your specific applications through our Application Engineering Team.

## GEN2 T-A® Recommended Drilling Data | Imperial (inch)

### Carbide Inserts

ISO	Material	Hardness (BHN)	Carbide Grade	SFM  AM300®	Feed Rate (IPR) by Diameter			
					3/8" - 1/2"	33/64" - 11/16"	45/64" - 15/16"	31/32" - 1-3/8"
P	Free-Machining Steel 1118, 1215, 12L14, etc.	100 - 150	C1	480	0.008	0.012	0.016	0.019
		150 - 200	C1	415	0.007	0.011	0.015	0.017
		200 - 250	C1	390	0.006	0.010	0.014	0.016
	Low-Carbon Steel 1010, 1020, 1025, 1522, 1144, etc.	85 - 125	C1	450	0.008 ❖	0.010	0.014	0.018
		125 - 175	C1	390	0.007 ❖	0.010	0.014	0.017
		175 - 225	C1	355	0.006 ❖	0.009	0.013	0.016
	Medium-Carbon Steel 1030, 1040, 1050, 1527, 1140, 1151, etc.	225 - 275	C1	310	0.005 ❖	0.009	0.013	0.016
		125 - 175	C1	390	0.007	0.010	0.014	0.017
		175 - 225	C1	355	0.006	0.009	0.013	0.016
	Alloy Steel 4140, 5140, 8640, etc.	225 - 275	C1	310	0.006	0.009	0.013	0.016
		275 - 325	C1	265	0.005	0.008	0.012	0.015
		275 - 325	C1	285	0.005	0.008	0.012	0.015
325 - 375		C1	255	0.004	0.007	0.011	0.014	
125 - 175		C1	375	0.007	0.010	0.014	0.017	
High-Strength Alloy 4340, 4330V, 300M, etc.	175 - 225	C1	345	0.006	0.009	0.013	0.016	
	225 - 300	C1	230	0.006 ❖	0.009	0.011	0.013	
	300 - 350	C1	205	0.005 ❖	0.008	0.010	0.012	
Structural Steel A36, A285, A516, etc.	350 - 400	C1	185	0.004 ❖	0.007	0.009	0.011	
	100 - 150	C1	355	0.008 ❖	0.011	0.015	0.017	
	150 - 250	C1	285	0.006 ❖	0.010	0.013	0.015	
Tool Steel H-13, H-21, A-4, O-2, S-3, etc.	250 - 350	C1	265	0.005 ❖	0.009	0.012	0.013	
	150 - 200	C1	255	0.007	0.007	0.010	0.012	
	200 - 250	C1	195	0.007	0.007	0.010	0.012	
	S	High-Temp Alloy Hastelloy B, Inconel 600, etc.	140 - 220	C2	120	0.004 ❖	0.007	0.009
220 - 310			C2	95	0.004 ❖	0.006	0.008	0.010
Titanium Alloy		140 - 220	C2	140	0.004 ❖	0.007	0.008	0.011
		220 - 310	C2	110	0.003 ❖	0.006	0.007	0.009
Aerospace Alloy S82		185 - 275	C2	240	0.005 ❖	0.006	0.007	0.009
	275 - 350	C2	180	0.004 ❖	0.005	0.006	0.008	
M	Stainless Steel 400 Series 416, 420, etc.	185 - 275	C2	240	0.007 ❖	0.009	0.012	0.014
		275 - 350	C2	180	0.006 ❖	0.008	0.011	0.012
	Stainless Steel 300 Series 304, 316, 17-4PH, etc.	135 - 185	C2	240	0.006 ❖	0.007	0.009	0.012
		185 - 275	C2	180	0.005 ❖	0.006	0.008	0.009
	Super Duplex Stainless Steel	135 - 185	C2	125	0.005 ❖	0.007	0.008	0.010
185 - 275		C2	100	0.004 ❖	0.006	0.007	0.009	

❖ Contact our Application Engineering department for assistance when machining these materials

**IMPORTANT:** The speeds and feeds listed above are a general starting point for all applications. Refer to the Coolant Recommendation charts for coolant requirements to run at the recommended speeds and feeds. Factory technical assistance is available through our Application Engineering department. See adjustment examples on the following page.

ISO	Material	Hardness (BHN)	Carbide Grade	SFM	Feed Rate (IPR) by Diameter			
				 AM300®	3/8" - 1/2"	33/64" - 11/16"	45/64" - 15/16"	31/32" - 1-3/8"
H	Wear Plate Hardox®, AR400, T-1, etc.	400	C2	150	0.003 ❖	0.005	0.008	0.010
		500	C2	120	0.002 ❖	0.004	0.006	0.008
		600	C2	100	0.001 ❖	0.003	0.005	0.006
	Hardened Steel	300 - 400	C1	150	0.004 ❖	0.006	0.009	0.011
		400 - 500	C1	120	0.003 ❖	0.005	0.008	0.010
K	Nodular, Grey, Ductile Cast Iron	120 - 150	C2	500	0.008	0.012	0.015	0.019
		150 - 200	C2	480	0.007	0.011	0.013	0.017
		200 - 220	C2	430	0.006	0.009	0.012	0.015
		220 - 260	C2	370	0.005	0.008	0.011	0.013
		260 - 320	C2	335	0.005	0.007	0.010	0.011
N	Cast Aluminum	30	C2	975	0.009	0.015	0.018	0.023
		180	C2	730	0.008	0.013	0.016	0.020
	Wrought Aluminum	30	C2	1385	0.005	0.013	0.016	0.020
		180	C2	975	0.005	0.007	0.012	0.014
	Aluminum Bronze	100 - 200	C2	360	0.006	0.009	0.012	0.015
		200 - 250	C2	300	0.005	0.007	0.009	0.011
	Brass	100	C2	650	0.007	0.011	0.013	0.018
Copper	60	C2	420	0.003 ❖	0.004	0.007	0.010	

❖ Contact our Application Engineering department for assistance when machining these materials

**Deep Hole Drilling Speed and Feed Adjustment**

	⚠ Holder Length				
	Extended	Long	Long Plus	XL	3XL
Speed	0.90	0.85	0.80	0.80	0.75
Feed	-	0.95	0.90	0.90	0.90

**Recommended Speed and Feed Example**

If the recommended speed and feed is 200 SFM and 0.008 IPR for a standard length holder, then the speed and feed using a 3XL holder in the same application would be 150 SFM and 0.007 IPR.

$200 \cdot 0.75 = 150 \text{ SFM}$	$0.008 \cdot 0.90 = 0.007 \text{ IPR}$
------------------------------------	--

**Formulas**

1. $RPM = (3.82 \cdot SFM) / DIA$ <i>where:</i> RPM = revolutions per minute (rev/min) SFM = speed (ft/min) DIA = diameter of drill (inch)	2. $IPM = RPM \cdot IPR$ <i>where:</i> IPM = inches per minute (in/min) RPM = revolutions per minute (rev/min) IPR = feed rate (in/rev)	3. $SFM = RPM \cdot 0.262 \cdot DIA$ <i>where:</i> SFM = speed (ft/min) RPM = revolutions per minute (rev/min) DIA = diameter of drill (inch)
--	---	---



**⚠ WARNING** Tool failure can cause serious injury. To prevent:

- When using holders without support bushing, use a short T-A® holder to establish an initial hole that is a minimum of 2 diameters deep.
- Do not rotate tool holder more than 50 RPM unless it is engaged with the workpiece or fixture.

Visit [www.alliedmachine.com/DeepHoleGuidelines](http://www.alliedmachine.com/DeepHoleGuidelines) for the most up-to-date information and procedures. Factory technical assistance is available for your specific applications through our Application Engineering Team.

## T-A® Recommended Drilling Data | Imperial (inch)

### HSS Inserts

ISO	Material	Hardness (BHN)	HSS Grade	SFM			Feed Rate (IPR) by Diameter	
				 TiN	 TiAlN	 TiCN	3/8" - 1/2"	33/64" - 11/16"
P	Free-Machining Steel 1118, 1215, 12L14, etc.	100 - 150	HSS	200	280	260	0.007	0.010
		150 - 200	HSS	180	260	235	0.007	0.010
		200 - 250	HSS	160	240	210	0.006	0.010
	Low-Carbon Steel 1010, 1020, 1025, 1522, 1144, etc.	85 - 125	HSS	170	250	220	0.006 ❖	0.009
		125 - 175	HSS	160	240	210	0.006 ❖	0.009
		175 - 225	HSS	150	225	195	0.005 ❖	0.008
	Medium-Carbon Steel 1030, 1040, 1050, 1527, 1140, 1151, etc.	225 - 275	HSS	140	210	180	0.005 ❖	0.008
		125 - 175	HSS	160	240	210	0.006	0.009
		175 - 225	HSS	150	225	195	0.005	0.008
	Alloy Steel 4140, 5140, 8640, etc.	225 - 275	HSS	140	210	180	0.005	0.008
		275 - 325	SC, PC	130	195	170	0.004	0.007
		325 - 375	SC, PC	110	155	145	0.003	0.006
High-Strength Alloy 4340, 4330V, 300M, etc.	275 - 325	SC, PC	120	170	155	0.004	0.006	
	350 - 400	PC	50	70	65	0.003 ❖	0.006	
	225 - 300	SC, PC	80	110	100	0.005 ❖	0.007	
Structural Steel A36, A285, A516, etc.	300 - 350	SC, PC	60	85	80	0.004 ❖	0.007	
	100 - 150	HSS	140	200	180	0.006 ❖	0.010	
	150 - 250	HSS	120	170	155	0.005 ❖	0.009	
Tool Steel H-13, H-21, A-4, O-2, S-3, etc.	250 - 350	SC, PC	100	140	130	0.003 ❖	0.008	
	150 - 200	SC	80	110	105	0.004	0.006	
S	High-Temp Alloy Hastelloy B, Inconel 600, etc.	200 - 250	SC, PC	60	90	85	0.004	0.006
		140 - 220	SC, PC	30	40	35	0.003 ❖	0.007
M	Titanium Alloy	220 - 310	PC	25	35	30	0.003 ❖	0.006
		140 - 220	SC, PC	35	50	45	0.003 ❖	0.007
	Aerospace Alloy S82	220 - 310	PC	30	45	35	0.003 ❖	0.006
		185 - 275	SC, PC	75	105	95	0.006 ❖	0.008
N	Stainless Steel 400 Series 416, 420, etc.	275 - 350	SC, PC	60	90	80	0.008	0.009
		135 - 185	SC, PC	75	105	95	0.007	0.007
	Stainless Steel 300 Series 304, 316, 17-4PH, etc.	185 - 275	SC, PC	60	90	80	0.006	0.006
		135 - 185	SC, PC	60	80	70	0.005	0.005
	Super Duplex Stainless Steel	185 - 275	SC, PC	50	65	60	0.004	0.005
H	Wear Plate Hardox®, AR400, T-1, etc.	400	SC, PC	45	70	55	0.003 ❖	0.006
		500	PC	35	45	40	0.002 ❖	0.005
		600	N/A	-	-	-	-	-
K	Hardened Steel	300 - 400	PC	50	95	70	0.003 ❖	0.006
		400 - 500	PC	35	45	40	0.002 ❖	0.005
X	Nodular, Grey, Ductile Cast Iron	120 - 150	HSS	170	250	220	0.007	0.012
		150 - 200	HSS	150	225	195	0.006	0.011
		200 - 220	HSS	130	195	170	0.006	0.009
		220 - 260	SC, PC	110	165	145	0.005	0.007
		260 - 320	SC, PC	90	135	120	0.004	0.006
SPECIALS	Cast Aluminum	30	HSS	600	850	750	0.008	0.013
		180	HSS	300	450	400	0.008	0.013
	Wrought Aluminum	30	HSS	600	850	750	0.004	0.006
		180	HSS	300	450	400	0.008	0.013
	Aluminum Bronze	100 - 200	SC	170	250	220	0.006	0.011
		200 - 250	SC	130	190	170	0.005	0.007
	Brass	100	HSS	300	445	400	0.007	0.012
Copper	60	SC	130	165	150	0.002 ❖	0.003	

❖ Contact our Application Engineering department for assistance when machining these materials

**IMPORTANT:** The speeds and feeds listed above are a general starting point for all applications. Refer to the Coolant Recommendation charts for coolant requirements to run at the recommended speeds and feeds. Factory technical assistance is available through our Application Engineering department. See adjustment examples on the following page.

Feed Rate (IPR) by Diameter				
45/64" - 15/16"	31/32" - 1-3/8"	1-13/32" - 1-7/8"	1-29/32" - 2-9/16"	2-19/32" - 4-1/2"
0.013	0.016	0.020	0.023	0.028
0.013	0.016	0.020	0.023	0.028
0.013	0.016	0.020	0.023	0.028
0.012	0.015	0.019	0.023	0.027
0.012	0.015	0.019	0.023	0.027
0.010	0.014	0.018	0.021	0.024
0.010	0.014	0.018	0.021	0.024
0.012	0.015	0.019	0.023	0.027
0.010	0.014	0.018	0.021	0.024
0.010	0.014	0.018	0.021	0.024
0.009	0.012	0.016	0.019	0.022
0.010	0.014	0.017	0.019	0.022
0.010	0.014	0.017	0.019	0.022
0.010	0.014	0.017	0.019	0.022
0.009	0.012	0.015	0.017	0.020
0.009	0.012	0.015	0.017	0.020
0.009	0.010	0.014	0.017	0.020
0.009	0.010	0.014	0.017	0.020
0.008	0.009	0.012	0.015	0.018
0.012	0.014	0.018	0.021	0.026
0.010	0.012	0.016	0.019	0.024
0.009	0.010	0.014	0.017	0.020
0.008	0.010	0.012	0.015	0.017
0.008	0.010	0.012	0.015	0.017
0.008	0.010	0.012	0.015	0.017
0.007	0.008	0.010	0.012	0.015
0.008	0.010	0.012	0.015	0.018
0.007	0.008	0.010	0.012	0.015
0.009	0.010	0.014	0.016	0.020
0.008	0.008	0.012	0.014	0.018
0.011	0.012	0.013	0.014	0.015
0.010	0.011	0.012	0.013	0.014
0.008	0.008	0.009	0.009	0.010
0.007	0.007	0.008	0.008	0.009
0.006	0.006	0.007	0.008	0.008
0.005	0.006	0.006	0.007	0.007
0.008	0.009	0.012	0.016	0.018
0.007	0.008	0.010	0.012	0.016
-	-	-	-	-
0.008	0.009	0.012	0.016	0.018
0.007	0.008	0.010	0.012	0.016
0.016	0.020	0.024	0.027	0.030
0.014	0.018	0.022	0.025	0.028
0.012	0.016	0.018	0.021	0.024
0.009	0.012	0.014	0.017	0.020
0.007	0.009	0.012	0.014	0.016
0.016	0.020	0.022	0.025	0.025
0.016	0.018	0.022	0.025	0.025
0.010	0.012	0.022	0.025	0.025
0.016	0.018	0.022	0.025	0.025
0.014	0.018	0.022	0.026	0.028
0.009	0.012	0.014	0.017	0.020
0.016	0.020	0.024	0.028	0.030
0.006	0.008	0.012	0.014	0.016

**Deep Hole Drilling Speed and Feed Adjustment**

	Holder Length				
	Extended	Long	Long Plus	XL	3XL
Speed	0.90	0.85	0.80	0.80	0.75
Feed	-	0.95	0.90	0.90	0.90

**Recommended Speed and Feed Example**

If the recommended speed and feed is 200 SFM and 0.008 IPR for a standard length holder, then the speed and feed using a 3XL holder in the same application would be 150 SFM and 0.007 IPR.

$200 \cdot 0.75 = 150 \text{ SFM}$

$0.008 \cdot 0.90 = 0.007 \text{ IPR}$

**Formulas**

- RPM = (3.82 • SFM) / DIA**

where:

  - RPM = revolutions per minute (rev/min)
  - SFM = speed (ft/min)
  - DIA = diameter of drill (inch)
- IPM = RPM • IPR**

where:

  - IPM = inches per minute (in/min)
  - RPM = revolutions per minute (rev/min)
  - IPR = feed rate (in/rev)
- SFM = RPM • 0.262 • DIA**

where:

  - SFM = speed (ft/min)
  - RPM = revolutions per minute (rev/min)
  - DIA = diameter of drill (inch)



**⚠ WARNING Tool failure can cause serious injury. To prevent:**

- When using holders without support bushing, use a short T-A® holder to establish an initial hole that is a minimum of 2 diameters deep.
- Do not rotate tool holder more than 50 RPM unless it is engaged with the workpiece or fixture.

Visit [www.alliedmachine.com/DeepHoleGuidelines](http://www.alliedmachine.com/DeepHoleGuidelines) for the most up-to-date information and procedures. Factory technical assistance is available for your specific applications through our Application Engineering Team.



## T-A® Recommended Drilling Data | Imperial (inch)

### Carbide Inserts

ISO	Material	Hardness (BHN)	Carbide Grade	SFM			Feed Rate (IPR) by Diameter				
				 TiN	 TiAlN	 TiCN	3/8" - 1/2"	33/64" - 11/16"	45/64" - 15/16"	31/32" - 1-3/8"	1-13/32" - 1-7/8"
P	Free-Machining Steel 1118, 1215, 12L14, etc.	100 - 150	C5	320	420	375	0.008	0.012	0.015	0.018	0.021
		150 - 200	C5	280	360	325	0.007	0.011	0.014	0.016	0.019
		200 - 250	C5	260	340	295	0.006	0.010	0.013	0.015	0.017
	Low-Carbon Steel 1010, 1020, 1025, 1522, 1144, etc.	85 - 125	C5	300	390	360	0.008 ❖	0.010	0.013	0.017	0.019
		125 - 175	C5	260	340	295	0.007 ❖	0.010	0.013	0.016	0.018
		175 - 225	C5	240	310	270	0.006 ❖	0.009	0.012	0.015	0.017
	Medium-Carbon Steel 1030, 1040, 1050, 1527, 1140, 1151, etc.	125 - 175	C5	260	340	295	0.007	0.010	0.013	0.016	0.018
		175 - 225	C5	240	310	275	0.006	0.009	0.012	0.015	0.017
		225 - 275	C5	210	270	235	0.006	0.009	0.012	0.015	0.017
	Alloy Steel 4140, 5140, 8640, etc.	275 - 325	C5	180	230	205	0.005	0.008	0.011	0.014	0.016
		125 - 175	C5	250	325	285	0.007	0.010	0.013	0.016	0.018
		175 - 225	C5	230	300	260	0.006	0.009	0.012	0.015	0.017
225 - 275		C5	210	270	235	0.006	0.009	0.012	0.015	0.017	
275 - 325		C5	200	250	225	0.005	0.008	0.011	0.014	0.016	
High-Strength Alloy 4340, 4330V, 300M, etc.	325 - 375	C5	170	220	195	0.004	0.007	0.010	0.013	0.015	
	225 - 300	C5	160	200	180	0.006 ❖	0.009	0.010	0.012	0.015	
	300 - 350	C5	140	180	160	0.005 ❖	0.008	0.009	0.011	0.014	
Structural Steel A36, A285, A516, etc.	350 - 400	C5	120	160	140	0.004 ❖	0.007	0.008	0.010	0.012	
	100 - 150	C5	240	310	275	0.008 ❖	0.011	0.014	0.016	0.018	
	150 - 250	C5	200	250	225	0.006 ❖	0.010	0.012	0.014	0.016	
Tool Steel H-13, H-21, A-4, O-2, S-3, etc.	250 - 350	C5	180	230	205	0.005 ❖	0.009	0.011	0.012	0.014	
	150 - 200	C5	160	220	190	0.004	0.007	0.009	0.011	0.013	
200 - 250	C5	120	170	145	0.004	0.007	0.009	0.011	0.013		
	S	High-Temp Alloy Hastelloy B, Inconel 600, etc.	140 - 220	C2	80	105	90	0.004 ❖	0.007	0.009	0.011
Titanium Alloy		220 - 310	C2	60	85	70	0.004 ❖	0.006	0.008	0.010	0.012
		140 - 220	C2	100	125	105	0.004 ❖	0.007	0.009	0.011	0.013
Aerospace Alloy S82		220 - 310	C2	80	110	90	0.004 ❖	0.006	0.008	0.010	0.012
		185 - 275	C2	160	210	185	0.007 ❖	0.006	0.011	0.014	0.016
275 - 350	C2	120	160	140	0.006 ❖	0.008	0.010	0.012	0.014		
M	Stainless Steel 400 Series 416, 420, etc.	185 - 275	C2	160	210	185	0.007 ❖	0.008	0.011	0.014	0.016
		275 - 350	C2	120	160	140	0.006 ❖	0.007	0.010	0.012	0.014
	Stainless Steel 300 Series 304, 316, 17-4PH, etc.	135 - 185	C2	160	210	185	0.005 ❖	0.007	0.009	0.010	0.012
		185 - 275	C2	120	160	140	0.004 ❖	0.006	0.008	0.009	0.010
	Super Duplex Stainless Steel	135 - 185	C2	80	110	95	0.004 ❖	0.007	0.008	0.009	0.011
185 - 275		C2	60	80	70	0.003 ❖	0.006	0.007	0.008	0.009	

❖ Contact our Application Engineering department for assistance when machining these materials

**IMPORTANT:** The speeds and feeds listed above are a general starting point for all applications. Refer to the Coolant Recommendation charts for coolant requirements to run at the recommended speeds and feeds. Factory technical assistance is available through our Application Engineering department. See adjustment examples on the following page.

ISO	Material	Hardness (BHN)	Carbide Grade	SFM			Feed Rate (IPR) by Diameter				
				 TiN	 TiAlN	 TiCN	3/8" - 1/2"	33/64" - 11/16"	45/64" - 15/16"	31/32" - 1-3/8"	1-13/32" - 1-7/8"
H	Wear Plate Hardox®, AR400, T-1, etc.	400	C5	75	115	100	0.003 ❖	0.006	0.008	0.010	0.012
		500	C5	50	85	70	0.002 ❖	0.005	0.006	0.008	0.010
		600	C5	35	75	55	0.001 ❖	0.004	0.005	0.006	0.008
	Hardened Steel	300 - 400	C5	110	140	130	0.004 ❖	0.006	0.009	0.011	0.013
400 - 500		C5	65	85	75	0.003 ❖	0.005	0.008	0.009	0.011	
K	Nodular, Grey, Ductile Cast Iron	120 - 150	C2, C3	320	460	415	0.008	0.012	0.015	0.019	0.023
		150 - 200	C2, C3	270	400	335	0.007	0.011	0.013	0.017	0.021
		200 - 220	C2, C3	240	360	305	0.006	0.009	0.012	0.015	0.018
		220 - 260	C2, C3	210	310	260	0.005	0.008	0.011	0.013	0.015
		260 - 320	C2, C3	180	270	225	0.005	0.007	0.010	0.011	0.013
N	Cast Aluminum	30	C2	1200	1500	1330	0.010	0.013	0.018	0.020	0.022
		180	C2	800	1000	900	0.009	0.013	0.016	0.018	0.020
	Wrought Aluminum	30	C2	1200	1500	1330	0.004	0.006	0.010	0.012	0.014
		180	C2	800	1000	900	0.008	0.013	0.014	0.018	0.020
	Aluminum Bronze	100 - 200	C2	275	360	325	0.005	0.008	0.010	0.014	0.017
		200 - 250	C2	210	305	260	0.004	0.007	0.007	0.010	0.013
	Brass	100	C2	425	600	520	0.006	0.009	0.011	0.015	0.018
Copper	60	C2	260	390	325	0.002 ❖	0.003	0.004	0.006	0.010	

❖ Contact our Application Engineering department for assistance when machining these materials

**Deep Hole Drilling Speed and Feed Adjustment**

	⚠ Holder Length				
	Extended	Long	Long Plus	XL	3XL
Speed	0.90	0.85	0.80	0.80	0.75
Feed	-	0.95	0.90	0.90	0.90

**Recommended Speed and Feed Example**

If the recommended speed and feed is 200 SFM and 0.008 IPR for a standard length holder, then the speed and feed using a 3XL holder in the same application would be 150 SFM and 0.007 IPR.

$200 \cdot 0.75 = 150 \text{ SFM}$	$0.008 \cdot 0.90 = 0.007 \text{ IPR}$
------------------------------------	--

**Formulas**

1. $RPM = (3.82 \cdot SFM) / DIA$ where: RPM = revolutions per minute (rev/min) SFM = speed (ft/min) DIA = diameter of drill (inch)	2. $IPM = RPM \cdot IPR$ where: IPM = inches per minute (in/min) RPM = revolutions per minute (rev/min) IPR = feed rate (in/rev)	3. $SFM = RPM \cdot 0.262 \cdot DIA$ where: SFM = speed (ft/min) RPM = revolutions per minute (rev/min) DIA = diameter of drill (inch)
---	--	--





**⚠ WARNING** Tool failure can cause serious injury. To prevent:

- When using holders without support bushing, use a short T-A® holder to establish an initial hole that is a minimum of 2 diameters deep.
- Do not rotate tool holder more than 50 RPM unless it is engaged with the workpiece or fixture.

Visit [www.alliedmachine.com/DeepHoleGuidelines](http://www.alliedmachine.com/DeepHoleGuidelines) for the most up-to-date information and procedures. Factory technical assistance is available for your specific applications through our Application Engineering Team.

## T-A® Recommended Drilling Data | Imperial (inch)

HSS Inserts | Flat Bottom Geometry

ISO	Material	Hardness (BHN)	HSS Grade	SFM			
				 TiN	 TiAlN	 TiCN	 AM200®
P	Free-Machining Steel 1118, 1215, 12L14, etc.	100 - 150	HSS	170	250	230	290
		150 - 200	HSS	155	230	205	265
		200 - 250	HSS	140	210	185	245
	Low-Carbon Steel 1010, 1020, 1025, 1522, 1144, etc.	85 - 125	HSS	150	220	195	255
		125 - 175	HSS	140	210	185	245
		175 - 225	HSS	130	195	175	225
		225 - 275	HSS	120	185	155	215
	Medium-Carbon Steel 1030, 1040, 1050, 1527, 1140, 1151, etc.	125 - 175	HSS	140	210	185	245
		175 - 225	HSS	130	195	175	225
		225 - 275	HSS	120	185	155	215
		275 - 325	SC	110	175	150	205
	Alloy Steel 4140, 5140, 8640, etc.	125 - 175	HSS	130	185	175	215
175 - 225		HSS	120	175	155	205	
225 - 275		HSS	110	155	145	180	
275 - 325		SC	105	145	135	170	
High-Strength Alloy 4340, 4330V, 300M, etc.	325 - 375	SC	95	135	125	155	
	225 - 300	SC	70	95	85	110	
	300 - 350	SC	50	75	70	90	
Structural Steel A36, A285, A516, etc.	350 - 400	SC	45	65	60	75	
	100 - 150	HSS	120	170	155	195	
	150 - 250	HSS	105	145	135	170	
Tool Steel H-13, H-21, A-4, O-2, S-3, etc.	250 - 350	SC	85	120	110	140	
	150 - 200	SC	70	95	90	110	
	200 - 250	SC	50	80	75	95	
	S	High-Temp Alloy Hastelloy B, Inconel 600, etc.	140 - 220	SC	25	35	30
		220 - 310	SC	20	30	25	35
Titanium Alloy		140 - 220	SC	35	45	40	50
		220 - 310	SC	26	40	35	45
Aerospace Alloy S82		185 - 275	SC	65	90	85	110
	275 - 350	SC	50	80	70	90	
M	Stainless Steel 400 Series 416, 420, etc.	140 - 220	SC	35	45	40	50
		220 - 310	SC	26	40	35	45
	Stainless Steel 300 Series 304, 316, 17-4PH, etc.	185 - 275	SC	65	90	85	110
		185 - 275	SC	50	80	70	90
	Super Duplex Stainless Steel	135 - 185	SC	65	90	85	110
185 - 275		SC	50	80	70	90	
H	Wear Plate Hardox®, AR400, T-1, etc.	400	SC	-	-	-	-
		500	SC	-	-	-	-
		600	N/A	-	-	-	-
	Hardened Steel	300 - 400	SC	45	65	60	80
400 - 500		SC	25	40	35	45	
K	Nodular, Grey, Ductile Cast Iron	120 - 150	HSS	150	220	195	255
		150 - 200	HSS	130	195	175	225
		200 - 220	HSS	110	175	150	205
		220 - 260	SC	95	150	125	175
		260 - 320	SC	80	120	105	140
N	Cast Aluminum	30	HSS	520	750	650	-
		180	HSS	260	400	350	-
	Wrought Aluminum	30	HSS	520	750	650	850
		180	HSS	260	400	350	450
	Aluminum Bronze	100 - 200	SC	130	190	175	230
		200 - 250	SC	95	150	125	165
Brass	100	HSS	150	220	190	250	
Copper	60	SC	115	150	130	170	

❖ Contact our Application Engineering department for assistance when machining these materials

**IMPORTANT:** The speeds and feeds listed above are a general starting point for all applications. Refer to the Coolant Recommendation charts for coolant requirements to run at the recommended speeds and feeds. Factory technical assistance is available through our Application Engineering department. See adjustment examples on the following page.



Feed Rate (IPR) by Diameter					
3/8" - 1/2"	33/64" - 11/16"	45/64" - 15/16"	31/32" - 1-3/8"	1-13/32" - 1-7/8"	1-29/32" - 2-9/16"
0.006	0.009	0.011	0.014	0.016	0.018
0.006	0.009	0.011	0.014	0.016	0.018
0.005	0.009	0.011	0.014	0.015	0.017
0.005 ❖	0.008	0.010	0.013	0.015	0.017
0.005 ❖	0.008	0.010	0.013	0.015	0.016
0.004 ❖	0.007	0.009	0.012	0.014	0.016
0.004 ❖	0.007	0.009	0.012	0.014	0.015
0.005	0.008	0.010	0.013	0.015	0.018
0.004	0.007	0.009	0.012	0.014	0.017
0.004	0.007	0.009	0.012	0.014	0.017
0.004	0.006	0.008	0.010	0.013	0.015
0.005	0.007	0.009	0.012	0.013	0.016
0.004	0.007	0.009	0.012	0.013	0.016
0.004	0.006	0.009	0.012	0.013	0.016
0.004	0.005	0.008	0.010	0.012	0.015
0.003	0.005	0.008	0.010	0.012	0.014
0.004 ❖	0.006	0.008	0.009	0.010	0.012
0.003 ❖	0.006	0.008	0.009	0.010	0.012
0.003 ❖	0.005	0.007	0.008	0.009	0.011
0.005 ❖	0.009	0.010	0.012	0.015	0.017
0.004 ❖	0.008	0.009	0.010	0.013	0.016
0.004 ❖	0.007	0.008	0.009	0.012	0.015
0.004	0.005	0.007	0.009	0.010	0.012
0.004	0.005	0.007	0.009	0.009	0.011
0.003 ❖	0.006	0.007	0.009	0.010	0.012
0.003 ❖	0.005	0.006	0.007	0.008	0.010
0.003 ❖	0.006	0.007	0.009	0.010	0.012
0.003 ❖	0.005	0.006	0.007	0.008	0.010
0.005 ❖	0.007	0.008	0.010	0.012	0.015
0.004 ❖	0.006	0.007	0.009	0.010	0.012
0.005 ❖	0.007	0.008	0.010	0.012	0.014
0.004 ❖	0.006	0.007	0.009	0.010	0.011
0.005 ❖	0.007	0.008	0.010	0.012	0.014
0.004 ❖	0.006	0.007	0.009	0.010	0.011
-	-	-	-	-	-
-	-	-	-	-	-
-	-	-	-	-	-
0.003 ❖	0.005	0.007	0.008	0.011	0.015
0.002 ❖	0.004	0.006	0.007	0.009	0.011
0.007	0.012	0.016	0.020	0.024	0.027
0.006	0.011	0.014	0.018	0.022	0.025
0.006	0.009	0.012	0.016	0.018	0.021
0.005	0.007	0.009	0.012	0.014	0.017
0.004	0.006	0.007	0.009	0.012	0.014
0.007	0.011	0.014	0.017	0.018	0.019
0.007	0.011	0.014	0.016	0.017	0.019
0.007	0.011	0.014	0.017	0.018	0.019
0.007	0.011	0.014	0.016	0.017	0.019
0.005	0.009	0.012	0.016	0.020	0.024
0.004	0.006	0.008	0.010	0.012	0.015
0.006	0.010	0.014	0.017	0.021	0.025
0.002 ❖	0.003	0.006	0.008	0.010	0.014

**Deep Hole Drilling Speed and Feed Adjustment**

	Holder Length				
	Extended	Long	Long Plus	XL	3XL
Speed	0.90	0.85	0.80	0.80	0.75
Feed	-	0.95	0.90	0.90	0.90

**Recommended Speed and Feed Example**

If the recommended speed and feed is 200 SFM and 0.008 IPR for a standard length holder, then the speed and feed using a 3XL holder in the same application would be 150 SFM and 0.007 IPR.

$200 \cdot 0.75 = 150 \text{ SFM}$

$0.008 \cdot 0.90 = 0.007 \text{ IPR}$

**Formulas**

1.	<b>RPM</b>	<b>= (3.82 • SFM) / DIA</b>
	where:	
	RPM	= revolutions per minute (rev/min)
	SFM	= speed (ft/min)
	DIA	= diameter of drill (inch)
2.	<b>IPM</b>	<b>= RPM • IPR</b>
	where:	
	IPM	= inches per minute (in/min)
	RPM	= revolutions per minute (rev/min)
	IPR	= feed rate (in/rev)
3.	<b>SFM</b>	<b>= RPM • 0.262 • DIA</b>
	where:	
	SFM	= speed (ft/min)
	RPM	= revolutions per minute (rev/min)
	DIA	= diameter of drill (inch)





**⚠ WARNING Tool failure can cause serious injury. To prevent:**

- When using holders without support bushing, use a short T-A® holder to establish an initial hole that is a minimum of 2 diameters deep.
- Do not rotate tool holder more than 50 RPM unless it is engaged with the workpiece or fixture.

Visit [www.alliedmachine.com/DeepHoleGuidelines](http://www.alliedmachine.com/DeepHoleGuidelines) for the most up-to-date information and procedures. Factory technical assistance is available for your specific applications through our Application Engineering Team.





## T-A® Recommended Drilling Data | Imperial (inch)

Carbide Inserts | Flat Bottom Geometry

ISO	Material	Hardness (BHN)	Carbide Grade	SFM				Feed Rate (IPR) by Diameter			
				 TiN	 TiAlN	 TiCN	 AM200®	3/8" - 1/2"	33/64" - 11/16"	45/64" - 15/16"	31/32" - 1-7/8"
P	Free-Machining Steel 1118, 1215, 12L14, etc.	100 - 150	C2	270	380	325	425	0.007	0.010	0.013	0.015
		150 - 200	C2	240	320	280	375	0.006	0.009	0.012	0.014
		200 - 250	C2	220	300	260	350	0.005	0.009	0.011	0.013
	Low-Carbon Steel 1010, 1020, 1025, 1522, 1144, etc.	85 - 125	C2	260	345	315	410	0.007 ❖	0.009	0.011	0.014
		125 - 175	C2	220	300	260	350	0.006 ❖	0.009	0.011	0.014
		175 - 225	C2	200	280	235	320	0.005 ❖	0.008	0.010	0.013
	Medium-Carbon Steel 1030, 1040, 1050, 1527, 1140, 1151, etc.	125 - 175	C2	220	300	260	350	0.006	0.009	0.011	0.014
		175 - 225	C2	200	280	240	320	0.005	0.008	0.010	0.013
		225 - 275	C2	180	240	215	285	0.004 ❖	0.008	0.010	0.013
	Alloy Steel 4140, 5140, 8640, etc.	125 - 175	C2	215	290	250	340	0.006	0.009	0.011	0.014
		175 - 225	C2	200	270	230	320	0.005	0.008	0.010	0.013
		225 - 275	C2	180	230	205	290	0.005	0.008	0.010	0.013
275 - 325		C2	175	215	190	280	0.004	0.007	0.009	0.012	
325 - 375		C2	145	190	170	230	0.003	0.006	0.009	0.011	
High-Strength Alloy 4340, 4330V, 300M, etc.	225 - 300	C2	140	170	160	220	0.005 ❖	0.008	0.009	0.010	
	300 - 350	C2	120	160	140	190	0.004 ❖	0.007	0.008	0.009	
	350 - 400	C2	100	145	120	160	0.003 ❖	0.006	0.007	0.009	
Structural Steel A36, A285, A516, etc.	100 - 150	C2	205	265	240	325	0.007 ❖	0.009	0.012	0.014	
	150 - 250	C2	170	215	200	270	0.005 ❖	0.009	0.010	0.012	
	250 - 350	C2	155	200	180	240	0.004 ❖	0.008	0.009	0.010	
Tool Steel H-13, H-21, A-4, O-2, S-3, etc.	150 - 200	C2	140	190	160	220	0.003	0.006	0.008	0.009	
	200 - 250	C2	100	150	120	160	0.003	0.006	0.008	0.009	
S	High-Temp Alloy Hastelloy B, Inconel 600, etc.	140 - 220	C2	70	90	80	110	0.003 ❖	0.006	0.008	0.009
		220 - 310	C2	50	70	60	80	0.003 ❖	0.005	0.007	0.009
	Titanium Alloy	140 - 220	C2	85	110	90	130	0.003 ❖	0.005	0.006	0.008
		220 - 310	C2	70	95	80	100	0.003 ❖	0.004	0.005	0.007
	Aerospace Alloy S82	185 - 275	C2	140	120	165	130	0.006 ❖	0.006	0.010	0.012
275 - 350		C2	110	90	125	105	0.005 ❖	0.005	0.009	0.010	
M	Stainless Steel 400 Series 416, 420, etc.	185 - 275	C2	140	180	165	210	0.006 ❖	0.008	0.010	0.012
		275 - 350	C2	110	140	125	160	0.005 ❖	0.007	0.009	0.010
	Stainless Steel 300 Series 304, 316, 17-4PH, etc.	135 - 185	C2	90	120	110	130	0.005 ❖	0.007	0.008	0.010
		185 - 275	C2	70	90	80	105	0.004 ❖	0.006	0.007	0.009
	Super Duplex Stainless Steel	135 - 185	C2	70	95	85	110	0.004 ❖	0.006	0.007	0.008
185 - 275		C2	55	70	60	85	0.003 ❖	0.005	0.006	0.007	

❖ Contact our Application Engineering department for assistance when machining these materials

**IMPORTANT:** The speeds and feeds listed above are a general starting point for all applications. Refer to the Coolant Recommendation charts for coolant requirements to run at the recommended speeds and feeds. Factory technical assistance is available through our Application Engineering department. See adjustment examples on the following page.

ISO	Material	Hardness (BHN)	Carbide Grade	SFM				Feed Rate (IPR) by Diameter			
				 TiN	 TiAlN	 TiCN	 AM200®	3/8" - 1/2"	33/64" - 11/16"	45/64" - 15/16"	31/32" - 1-7/8"
H	Wear Plate Hardox®, AR400, T-1, etc.	400	C2	65	100	85	130	0.003 ❖	0.004	0.006	0.008
		500	C2	45	75	60	100	0.002 ❖	0.003	0.005	0.006
		600	C2	35	65	45	80	0.001 ❖	0.002	0.004	0.005
	Hardened Steel	300 - 400	C2	100	125	110	135	0.004 ❖	0.006	0.007	0.009
400 - 500		C2	60	75	65	110	0.003 ❖	0.005	0.006	0.007	
K	Nodular, Grey, Ductile Cast Iron	120 - 150	C2	270	405	360	450	0.007	0.010	0.013	0.016
		150 - 200	C2	230	350	290	390	0.006	0.009	0.011	0.014
		200 - 220	C2	200	320	260	350	0.005	0.008	0.010	0.013
		220 - 260	C2	180	270	220	300	0.004	0.007	0.009	0.011
		260 - 320	C2	160	240	200	265	0.004	0.006	0.009	0.009
N	Cast Aluminum	30	C2	520	750	650	-	0.009	0.013	0.016	0.017
		180	C2	260	400	350	-	0.008	0.012	0.014	0.015
	Wrought Aluminum	30	C2	950	1200	1070	1270	0.005	0.007	0.009	0.010
		180	C2	630	800	715	850	0.004	0.006	0.008	0.009
	Aluminum Bronze	100 - 200	C2	240	310	280	340	0.004	0.006	0.008	0.011
		200 - 250	C2	180	265	220	285	0.003	0.005	0.006	0.008
	Brass	100	C2	370	520	450	600	0.005	0.006	0.008	0.012
Copper	60	C2	220	345	280	380	0.002 ❖	0.002	0.003	0.005	

❖ Contact our Application Engineering department for assistance when machining these materials

**Deep Hole Drilling Speed and Feed Adjustment**

	⚠ Holder Length				
	Extended	Long	Long Plus	XL	3XL
Speed	0.90	0.85	0.80	0.80	0.75
Feed	-	0.95	0.90	0.90	0.90

**Recommended Speed and Feed Example**

If the recommended speed and feed is 200 SFM and 0.008 IPR for a standard length holder, then the speed and feed using a 3XL holder in the same application would be 150 SFM and 0.007 IPR.

$200 \cdot 0.75 = 150 \text{ SFM}$	$0.008 \cdot 0.90 = 0.007 \text{ IPR}$
------------------------------------	--

**Formulas**

1. $RPM = (3.82 \cdot SFM) / DIA$ <i>where:</i> RPM = revolutions per minute (rev/min) SFM = speed (ft/min) DIA = diameter of drill (inch)	2. $IPM = RPM \cdot IPR$ <i>where:</i> IPM = inches per minute (in/min) RPM = revolutions per minute (rev/min) IPR = feed rate (in/rev)	3. $SFM = RPM \cdot 0.262 \cdot DIA$ <i>where:</i> SFM = speed (ft/min) RPM = revolutions per minute (rev/min) DIA = diameter of drill (inch)
--	---	---

**⚠ WARNING** Tool failure can cause serious injury. To prevent:

- When using holders without support bushing, use a short T-A® holder to establish an initial hole that is a minimum of 2 diameters deep.
- Do not rotate tool holder more than 50 RPM unless it is engaged with the workpiece or fixture.

Visit [www.alliedmachine.com/DeepHoleGuidelines](http://www.alliedmachine.com/DeepHoleGuidelines) for the most up-to-date information and procedures. Factory technical assistance is available for your specific applications through our Application Engineering Team.

A DRILLING  
B BORING  
C REAMING  
D BURNISHING  
E THREADING  
X SPECIALS

## T-A® Recommended Drilling Data | Imperial (inch)

Carbide Inserts | Diamond Coating

Material	Carbide Grade	SFM  Diamond Coating	Feed Rate (IPR) by Diameter				
			3/8" - 1/2"	33/64" - 11/16"	45/64" - 15/16"	31/32" - 1-3/8"	
Polymer Matrix Composites	Carbon (hard)	N2	1000 - 1500	0.004 - 0.006	0.008 - 0.010	0.010 - 0.012	0.012 - 0.014
	Carbon Fiber	N2	1000 - 1500	0.004 - 0.006	0.008 - 0.010	0.010 - 0.012	0.012 - 0.014
	Carbon / Glass Fiber	N2	1000 - 1500	0.004 - 0.006	0.008 - 0.010	0.010 - 0.012	0.012 - 0.014
	Fiberglass	N2	1000 - 1500	0.004 - 0.006	0.008 - 0.010	0.010 - 0.012	0.012 - 0.014
	Graphite	N2	1000 - 1500	0.004 - 0.006	0.008 - 0.010	0.010 - 0.012	0.012 - 0.014
	Plastics	N2	250 - 1000	0.004 - 0.006	0.008 - 0.010	0.010 - 0.012	0.012 - 0.014
	Epoxy Resin	N2	250 - 1000	0.004 - 0.006	0.008 - 0.010	0.010 - 0.012	0.012 - 0.014
	Bismaleimide Resin	N2	250 - 1000	0.004 - 0.006	0.008 - 0.010	0.010 - 0.012	0.012 - 0.014
	Polyester Resin	N2	250 - 1000	0.004 - 0.006	0.008 - 0.010	0.010 - 0.012	0.012 - 0.014
	Phenolic Resin	N2	250 - 1000	0.004 - 0.006	0.008 - 0.010	0.010 - 0.012	0.012 - 0.014
Rubber	N2	250 - 1000	0.004 - 0.006	0.008 - 0.010	0.010 - 0.012	0.012 - 0.014	
Metal Matrix Composites	Aluminum	N2	1000	0.008	0.013	0.016	0.020
	Si < 10%	N2	1000	0.008	0.013	0.016	0.020
	10% < Si < 15%	N2	850 - 1000	0.008	0.013	0.016	0.020
	15% < Si < 20%	N2	650 - 850	0.008	0.013	0.016	0.020
	20% < Si < 25%	N2	500 - 650	0.008	0.013	0.016	0.020
	25% < Si	N2	200 - 500	0.008	0.013	0.016	0.020
	Brass	N2	250 - 500	0.008	0.013	0.016	0.020
	Bronze	N2	250 - 500	0.008	0.013	0.016	0.020
	Copper	N2	100 - 250	0.004 - 0.006	0.008 - 0.010	0.010 - 0.012	0.012 - 0.014
	Copper Alloys	N2	100 - 250	0.004 - 0.006	0.008 - 0.010	0.010 - 0.012	0.012 - 0.014
	Lead Alloys	N2	100 - 250	0.004 - 0.006	0.008 - 0.010	0.010 - 0.012	0.012 - 0.014
	Magnesium Alloys	N2	100 - 250	0.004 - 0.006	0.008 - 0.010	0.010 - 0.012	0.012 - 0.014
	Precious Metals	N2	100 - 250	0.004 - 0.006	0.008 - 0.010	0.010 - 0.012	0.012 - 0.014
Ceramic Matrix Composites	Carbide (green)	N2	50 - 250	0.004 - 0.006	0.008 - 0.010	0.010 - 0.012	0.012 - 0.014
	Ceramic (green)	N2	50 - 250	0.004 - 0.006	0.008 - 0.010	0.010 - 0.012	0.012 - 0.014
	Ceramic (pre-sintered)	N2	50 - 250	0.004 - 0.006	0.008 - 0.010	0.010 - 0.012	0.012 - 0.014

### Deep Hole Drilling Speed and Feed Adjustment

	Holder Length				
	Extended	Long	Long Plus	XL	3XL
Speed	0.90	0.85	0.80	0.80	0.75
Feed	-	0.95	0.90	0.90	0.90

### Recommended Speed and Feed Example

If the recommended speed and feed is 200 SFM and 0.008 IPR for a standard length holder, then the speed and feed using a 3XL holder in the same application would be 150 SFM and 0.007 IPR.

$$200 \cdot 0.75 = 150 \text{ SFM}$$

$$0.008 \cdot 0.90 = 0.007 \text{ IPR}$$

#### **⚠ WARNING** Tool failure can cause serious injury. To prevent:

- When using holders without support bushing, use a short T-A® holder to establish an initial hole that is a minimum of 2 diameters deep.
- Do not rotate tool holder more than 50 RPM unless it is engaged with the workpiece or fixture.

Visit [www.alliedmachine.com/DeepHoleGuidelines](http://www.alliedmachine.com/DeepHoleGuidelines) for the most up-to-date information and procedures. Factory technical assistance is available for your specific applications through our Application Engineering Team.

**IMPORTANT:** The speeds and feeds listed above are a general starting point for all applications. Refer to the Coolant Recommendation charts for coolant requirements to run at the recommended speeds and feeds. Factory technical assistance is available through our Application Engineering department. See adjustment examples on the following page.

## Tap Drill Information and Formulas | Imperial (inch)

### American - Unified Inch Screw Thread

Tap Size	Tap Drill Size	Decimal Equivalent	* Theo % Thread	Probable Mean Oversize	Probable Hole Size	** Probable % Thread
7/16 - 20	W	0.3860	79%	0.003"	0.3890"	75%
7/16 - 20	25/64"	0.3906	72%	0.003"	0.3936"	68%
1/2 - 13	10.5 mm	0.4134	87%	0.003"	0.4164"	84%
1/2 - 13	27/64"	0.4219	78%	0.003"	0.4249"	75%
1/2 - 13	7/16"	0.4375	63%	0.003"	0.4405"	60%
1/2 - 20	29/64"	0.4531	72%	0.003"	0.4561"	68%
9/16 - 12	15/32"	0.4688	87%	0.003"	0.4718"	84%
9/16 - 12	12.0 mm	0.4724	72%	0.003"	0.4874"	69%
9/16 - 12	31/64"	0.4844	83%	0.003"	0.4754"	80%
9/16 - 18	1/2"	0.5000"	87%	0.003"	0.5030"	82%
9/16 - 18	13.0 mm	0.5118"	70%	0.003"	0.5148"	66%
9/16 - 18	31/64"	0.5156"	65%	0.003"	0.5186"	61%
5/8 - 11	17/32"	0.5313"	79%	0.003"	0.5343"	77%
5/8 - 12	35/64"	0.5469"	72%	0.003"	0.5499"	69%
5/8 - 18	9/16"	0.5625"	87%	0.003"	0.5655"	82%
5/8 - 18	14.5 mm	0.5709"	75%	0.003"	0.5739"	75%
5/8 - 18	37/64"	0.5781"	65%	0.003"	0.5811"	70%
11/16 - 12	39/64"	0.6094"	72%	0.003"	0.6124"	69%
3/4 - 10	41/64"	0.6406"	84%	0.003"	0.6436"	82%
3/4 - 10	16.5 mm	0.6496"	77%	0.003"	0.6526"	75%
3/4 - 10	21/32"	0.6563"	72%	0.003"	0.6593"	70%
3/4 - 12	43/64"	0.6719"	72%	0.003"	0.6749"	69%
3/4 - 16	11/16"	0.6875"	77%	0.003"	0.6905"	73%
3/4 - 16	17.5 mm	0.6890"	75%	0.003"	0.6920"	71%
7/8 - 9	49/64"	0.7656"	76%	0.003"	0.7686"	74%
7/8 - 9	25/32"	0.7813"	65%	0.003"	0.7843"	63%
7/8 - 14	51/64"	0.7969"	84%	0.003"	0.7999"	81%
7/8 - 14	13/16"	0.8125"	67%	0.003"	0.8155"	64%
15/16 - 12	55/64"	0.8594"	72%	0.003"	0.8624"	69%
15/16 - 20	57/64"	0.8906"	72%	0.003"	0.8936"	68%
1 - 8	22.0 mm	0.8661"	82%	0.003"	0.8691"	81%
1 - 8	7/8"	0.8750"	77%	0.003"	0.8780"	75%
1 - 8	57/64"	0.8906"	67%	0.003"	0.8936"	65%
1 - 12	29/32"	0.9063"	87%	0.003"	0.9093"	84%
1 - 12	59/64"	0.9219"	72%	0.003"	0.9249"	69%
1 - 14	15/16"	0.9375"	67%	0.003"	0.9405"	64%
1-1/8 - 12	1-1/32"	1.0313"	87%	0.003"	1.0343"	84%
1-1/8 - 12	1-3/64"	1.0469"	72%	0.003"	1.0499"	69%
1-1/4 - 7	1-7/64"	1.1094"	76%	0.003"	1.1124"	74%
24 x 2	7/8"	0.8750"	68%	0.003"	0.8780"	65%
27 x 3	24.0 mm	0.9449"	77%	0.003"	0.9403"	75%

### Taper Pipe Thread (NPT)

Tap Size	Tap Drill Size	Decimal Equivalent	Theo % Thread*	Probable Mean Oversize	Probable Hole Size	Probable % Thread**
1/4 - 18	7/16	0.4375	-	0.003	0.4405	-
3/8 - 18	9/16	0.5625	-	0.003	0.5655	-
1/2 - 14	45/64	0.7031	-	0.003	0.7061	-
3/4 - 14	29/32	0.9063	-	0.003	0.9093	-

\* Based on nominal tap drill diameter

\*\* Based on 0.003" probable mean oversize

To calculate the percent of full thread for a given hole diameter:

$$\% \text{ Thread} = \# \text{ of Thread per Inch} \left[ \frac{\text{Basic Major Diameter of Thread} - \text{Drill Hole Size}}{0.0130} \right]$$

### Notes

- The above tap drill information represents probable thread percentages for the standard tap drills stocked at Allied Machine. Special insert diameters may be required in order to meet a user specific percentage of thread requirements.
- The 0.003" probable mean oversize hole condition is based on optimum cutting conditions. Probable percent of full thread may vary based on less ideal cutting conditions.
- The table and equations on this page are found in the *Machinery's Handbook*. Permission to simplify and print the equations is granted by the editor of the *Machinery's Handbook*.

### Formulas

1.	<b>RPM</b>	= (3.82 • SFM) / DIA
	where:	
	RPM	= revolutions per minute (rev/min)
	SFM	= speed (ft/min)
	DIA	= diameter of drill (inch)
2.	<b>IPM</b>	= RPM • IPR
	where:	
	IPM	= inches per minute (in/min)
	RPM	= revolutions per minute (rev/min)
	IPR	= feed rate (in/rev)
3.	<b>SFM</b>	= RPM • 0.262 • DIA
	where:	
	SFM	= speed (ft/min)
	RPM	= revolutions per minute (rev/min)
	DIA	= diameter of drill (inch)
4.	<b>Thrust</b>	= 153,700 • IPR • DIA • K <sub>m</sub>
	where:	
	Thrust	= axial thrust (lbs)
	IPR	= feed rate (in/rev)
	DIA	= diameter of drill (inch)
	K <sub>m</sub>	= specific cutting energy (lbs/in <sup>2</sup> )
5.	<b>Tool Power</b>	= .6283 • IPR • RPM • K <sub>m</sub> • DIA <sup>2</sup>
	where:	
	Tool Power	= tool power (HP)
	IPR	= feed rate (in/rev)
	RPM	= revolutions per minute (rev/min)
	K <sub>m</sub>	= specific cutting energy (lbs/in <sup>2</sup> )
	DIA	= diameter of drill (inch)

### Material Constants

Type of Material	Hardness	K <sub>m</sub> (lbs/in <sup>2</sup> )
Plain Carbon and Alloy Steel	85 - 200 BHN	0.79
	200 - 275 BHN	0.94
	275 - 375 BHN	1.00
	375 - 425 BHN	1.15
High-Temperature Alloys	-	1.44
Stainless Steels	135 - 275 BHN	0.94
	30 - 45 RC	1.08
Cast Iron	100 - 200 BHN	0.50
	200 - 300 BHN	1.08
Copper Alloy	20 - 80 RB	0.43
	80 - 100 RB	0.72
Titanium Alloy	-	0.72
Aluminum Alloy	-	0.22
Magnesium Alloy	-	0.16

## Coolant Recommendations | Imperial (inch)

### HSS Drill Inserts

ISO	Material	Pressure or Flow Rate	3/8" - 1/2"	33/64" - 11/16"	23/32" - 1"	1" - 1-1/4"	1-1/4" - 2"	2" - 3"	3" - 4"	
P	Free-Machining Steel 1118, 1215, 12L14, etc.	PSI	175 - 185	100 - 120	105 - 140	80 - 115	75 - 100	40 - 50	65 - 90	
		GPM	2.5 - 2.6	2.8 - 3.0	4.4 - 5.2	7 - 8	12 - 14	30 - 33	38 - 44	
	Low-Carbon Steel 1010, 1020, 1025, 1522, 1144, etc.	PSI	165 - 170	75 - 90	75 - 95	60 - 80	55 - 75	30 - 40	50 - 65	
		GPM	2.4 - 2.5	2.4 - 2.6	3.7 - 4.2	6 - 7	11 - 12	26 - 30	33 - 38	
	Medium-Carbon Steel 1030, 1040, 1050, 1527, 1140, 1151, etc.	PSI	160 - 165	70 - 85	70 - 90	55 - 75	50 - 70	30 - 40	50 - 65	
		GPM	2.3 - 2.4	2.3 - 2.6	3.7 - 4.2	5 - 6	10 - 12	26 - 30	33 - 38	
	Alloy Steel 4140, 5140, 8640, etc.	PSI	160 - 165	65 - 75	65 - 80	50 - 70	45 - 60	30 - 35	40 - 50	
		GPM	2.3 - 2.4	2.2 - 2.4	3.5 - 3.9	5 - 6	10 - 11	26 - 28	30 - 33	
	High-Strength Alloy 4340, 4330V, 300M, etc.	PSI	150 - 155	55 - 60	45 - 50	25 - 30	25 - 30	20 - 25	40 - 50	
		GPM	2.3 - 2.4	2.1 - 2.2	2.9 - 3.1	4 - 5	7 - 8	21 - 23	23 - 26	
	Structural Steel A36, A285, A516, etc.	PSI	160 - 165	75 - 85	65 - 80	40 - 55	40 - 50	25 - 30	40 - 50	
		GPM	2.3 - 2.4	2.4 - 2.6	3.5 - 3.9	5 - 6	9 - 10	23 - 26	30 - 33	
	Tool Steel H-13, H-21, A-4, O-2, S-3, etc.	PSI	150 - 155	55 - 60	45 - 50	25 - 30	25 - 30	20 - 25	25 - 30	
		GPM	2.3 - 2.4	2.1 - 2.2	2.9 - 3.1	4 - 5	7 - 8	21 - 23	23 - 26	
	S	High-Temp Alloy Hastelloy B, Inconel 600, etc.	PSI	150 - 155	60 - 65	50 - 55	30 - 35	25 - 30	25 - 30	44
			GPM	2.3 - 2.4	2.2 - 2.3	3.1 - 3.2	4 - 5	7 - 8	23 - 26	33
Titanium Alloy		PSI	150 - 155	60 - 65	50 - 55	30 - 35	25 - 30	25 - 30	44	
		GPM	2.3 - 2.4	2.2 - 2.3	3.1 - 3.2	4 - 5	7 - 8	23 - 26	33	
Aerospace Alloy S82	PSI	150 - 155	60 - 65	50 - 55	30 - 35	25 - 30	25 - 30	44		
	GPM	2.3 - 2.4	2.2 - 2.3	3.1 - 3.2	4 - 5	7 - 8	23 - 26	33		
M	Stainless Steel 400 Series 416, 420, etc.	PSI	171	86	75	55	51	29	45	
		GPM	3	3	4	6	10	26	31	
	Stainless Steel 300 Series 304, 316, 17-4PH, etc.	PSI	171	86	75	55	51	29	45	
		GPM	3	3	4	6	10	26	31	
Super Duplex Stainless Steel	PSI	171	86	75	55	51	29	45		
	GPM	3	3	4	6	10	26	31		
H	Wear Plate Hardox®, AR400, T-1, etc.	PSI	155	61	51	29	29	25	29	
		GPM	2	2	3	5	8	23	26	
	Hardened Steel	PSI	155	61	51	29	29	25	29	
		GPM	2	2	3	5	8	23	26	
K	SG / Nodular Cast Iron	PSI	160	65	61	41	35	29	35	
		GPM	2	2	3	5	9	26	28	
	Grey / White Iron	PSI	160	65	61	41	35	29	35	
		GPM	2	2	3	5	9	26	28	
N	Cast Aluminum	PSI	210	180	230	159	125	51	80	
		GPM	3	4	6	9	16	33	42	
	Wrought Aluminum	PSI	210	180	230	159	125	51	80	
		GPM	3	4	6	9	16	33	42	
	Aluminum Bronze	PSI	186	120	140	115	100	51	90	
		GPM	2.5	3	5	8	14	33	44	
	Brass	PSI	159	65	61	41	35	29	35	
		GPM	2	2	3	5	9	26	28	
Copper	PSI	186	120	140	115	100	51	90		
	GPM	2.5	3	5	8	14	33	44		

#### Deep Hole Drilling Coolant Adjustment

	Holder Length				
	Extended	Long	Long Plus	XL	3XL
Pressure and Flow	1.3	1.5	2	2	3

#### Recommended Coolant Example

If the recommended pressure and flow is 150 PSI and 2.4 GPM for a standard length holder, then the adjusted pressure and flow for a 3XL holder would be 450 PSI and 7.2 GPM.

$$150 \cdot 3 = 450 \text{ PSI} \qquad 2.4 \cdot 3 = 7.2 \text{ GPM}$$

#### ⚠️ WARNING Tool failure can cause serious injury. To prevent:

- When using holders without support bushing, use a short T-A® holder to establish an initial hole that is a minimum of 2 diameters deep.
- Do not rotate tool holder more than 50 RPM unless it is engaged with the workpiece or fixture.

Visit [www.alliedmachine.com/DeepHoleGuidelines](http://www.alliedmachine.com/DeepHoleGuidelines) for the most up-to-date information and procedures. Factory technical assistance is available for your specific applications through our Application Engineering Team.

**IMPORTANT:** The coolant pressure and flow rate recommendations above represent a good approximation to obtain optimum tool life and chip evacuation at Allied Machine recommended speeds and feeds. If lower coolant capabilities exist in a drilling application, the T-A® drilling system will still function at reduced penetration rates. Contact our Application Engineering department for a more specific recommendation of coolant requirements and/or speeds and feeds.

## Coolant Recommendations | Imperial (inch)

### Carbide Drill Inserts

ISO	Material	Pressure or Flow Rate	3/8" - 1/2"	33/64" - 11/16"	23/32" - 1"	1" - 1-3/8"	1-13/32" - 1-7/8"
P	Free-Machining Steel 1118, 1215, 12L14, etc.	PSI	195	140	160	140	155
		GPM	2.6	3.3	5.5	9	18
	Low-Carbon Steel 1010, 1020, 1025, 1522, 1144, etc.	PSI	180	105	105	110	115
		GPM	2.5	2.9	4.4	8	15
	Medium-Carbon Steel 1030, 1040, 1050, 1527, 1140, 1151, etc.	PSI	175	100	90	70	75
		GPM	2.5	2.8	4.1	7	13
	Alloy Steel 4140, 5140, 8640, etc.	PSI	165	85	100	75	70
		GPM	2.4	2.6	4.3	6	12
	High-Strength Alloy 4340, 4330V, 300M, etc.	PSI	175	115	105	75	70
		GPM	2.4	2.3	3.2	5	8
Structural Steel A36, A285, A516, etc.	PSI	175	115	105	75	70	
	GPM	2.5	3.0	4.4	6	12	
Tool Steel H-13, H-21, A-4, O-2, S-3, etc.	PSI	155	60	55	40	35	
	GPM	2.4	2.2	3.2	5	8	
S	High-Temp Alloy Hastelloy B, Inconel 600, etc.	PSI	247	160	174	160	130
		GPM	3	4	6	9	16
	Titanium Alloy	PSI	247	160	174	160	130
		GPM	3	4	6	9	16
Aerospace Alloy S82	PSI	247	160	174	160	130	
	GPM	3	4	6	9	16	
M	Stainless Steel 400 Series 416, 420, etc.	PSI	329	239	260	250	190
		GPM	3	4	7	12	20
	Stainless Steel 300 Series 304, 316, 17-4PH, etc.	PSI	329	239	260	250	190
		GPM	3	4	7	12	20
Super Duplex Stainless Steel	PSI	329	239	260	250	190	
	GPM	3	4	7	12	20	
H	Wear Plate Hardox®, AR400, T-1, etc.	PSI	210	75	70	49	45
		GPM	3	2	4	5	10
	Hardened Steel	PSI	210	75	70	49	45
		GPM	3	2	4	5	10
K	SG / Nodular Cast Iron	PSI	225	104	90	90	80
		GPM	3	3	4	7	13
	Grey / White Iron	PSI	225	104	90	90	80
		GPM	3	3	4	7	13
N	Cast Aluminum	PSI	350	319	315	284	200
		GPM	4	5	8	12	20
	Wrought Aluminum	PSI	350	319	315	284	200
		GPM	4	5	8	12	20
	Aluminum Bronze	PSI	290	239	239	220	174
		GPM	3	4	7	11	19
	Brass	PSI	350	319	315	284	200
		GPM	4	5	7	12	20
	Copper	PSI	290	239	239	220	174
		GPM	3	4	7	11	19

#### Deep Hole Drilling Coolant Adjustment

	Holder Length				
	Extended	Long	Long Plus	XL	3XL
Pressure and Flow	1.3	1.5	2	2	3

#### Recommended Coolant Example

If the recommended pressure and flow is 150 PSI and 2.4 GPM for a standard length holder, then the adjusted pressure and flow for a 3XL holder would be 450 PSI and 7.2 GPM.

$$150 \cdot 3 = 450 \text{ PSI}$$

$$2.4 \cdot 3 = 7.2 \text{ GPM}$$

#### ⚠ WARNING Tool failure can cause serious injury. To prevent:

- When using holders without support bushing, use a short T-A® holder to establish an initial hole that is a minimum of 2 diameters deep.
- Do not rotate tool holder more than 50 RPM unless it is engaged with the workpiece or fixture.

Visit [www.alliedmachine.com/DeepHoleGuidelines](http://www.alliedmachine.com/DeepHoleGuidelines) for the most up-to-date information and procedures. Factory technical assistance is available for your specific applications through our Application Engineering Team.

**IMPORTANT:** The coolant pressure and flow rate recommendations above represent a good approximation to obtain optimum tool life and chip evacuation at Allied Machine recommended speeds and feeds. If lower coolant capabilities exist in a drilling application, the T-A® drilling system will still function at reduced penetration rates. Contact our Application Engineering department for a more specific recommendation of coolant requirements and/or speeds and feeds.

## GEN2 T-A® Recommended Drilling Data | Metric (mm)

### HSS Inserts

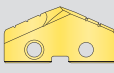
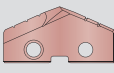
ISO	Material	Hardness (BHN)	HSS Grade	M/min		Feed Rate (mm/rev) by Diameter	
				 TiN	 AM200®	9.50 mm - 12.95 mm	12.98 mm - 17.52 mm
P	Free-Machining Steel 1118, 1215, 12L14, etc.	100 - 150	HSS	61	99	0.20	0.30
		150 - 200	HSS	55	91	0.18	0.28
		200 - 250	HSS	49	85	0.15	0.25
	Low-Carbon Steel 1010, 1020, 1025, 1522, 1144, etc.	85 - 125	HSS	52	88	0.20 ❖	0.25
		125 - 175	HSS	49	83	0.18 ❖	0.25
		175 - 225	HSS	46	79	0.15 ❖	0.23
	Medium-Carbon Steel 1030, 1040, 1050, 1527, 1140, 1151, etc.	225 - 275	HSS	43	73	0.13 ❖	0.23
		125 - 175	HSS	49	83	0.18	0.25
		175 - 225	HSS	46	79	0.15	0.23
	Alloy Steel 4140, 5140, 8640, etc.	225 - 275	HSS	43	73	0.15	0.23
		275 - 325	SC, PC	40	68	0.13	0.20
		325 - 375	SC, PC	34	54	0.10	0.18
275 - 325		SC, PC	37	59	0.13	0.20	
High-Strength Alloy 4340, 4330V, 300M, etc.	350 - 400	PC	15	24	0.10 ❖	0.18	
	225 - 300	SC, PC	24	38	0.15 ❖	0.23	
	300 - 350	SC, PC	18	30	0.13 ❖	0.20	
Structural Steel A36, A285, A516, etc.	250 - 350	SC, PC	30	48	0.13 ❖	0.23	
	100 - 150	HSS	43	71	0.20 ❖	0.28	
	150 - 250	HSS	37	57	0.15 ❖	0.25	
Tool Steel H-13, H-21, A-4, O-2, S-3, etc.	250 - 350	SC, PC	30	48	0.13 ❖	0.23	
	150 - 200	SC	24	38	0.10	0.18	
S	High-Temp Alloy Hastelloy B, Inconel 600, etc.	200 - 250	SC, PC	18	32	0.10	0.18
		140 - 220	SC, PC	9	13	0.10 ❖	0.18
	Titanium Alloy	220 - 310	PC	8	12	0.10 ❖	0.15
		140 - 220	SC, PC	11	16	0.10 ❖	0.18
	Aerospace Alloy S82	220 - 310	PC	10	15	0.08 ❖	0.15
185 - 275		SC, PC	23	35	0.15 ❖	0.20	
M	Stainless Steel 400 Series 416, 420, etc.	275 - 350	SC, PC	18	31	0.13 ❖	0.18
		185 - 275	SC, PC	15	22	0.08 ❖	0.15
	Stainless Steel 300 Series 304, 316, 17-4PH, etc.	135 - 185	SC, PC	23	35	0.08 ❖	0.18
		185 - 275	SC, PC	18	31	0.08 ❖	0.15
	Super Duplex Stainless Steel	135 - 185	SC, PC	18	26	0.08 ❖	0.18
185 - 275		SC, PC	15	22	0.08 ❖	0.15	
H	Wear Plate Hardox®, AR400, T-1, etc.	400	SC, PC	14	21	0.08 ❖	0.15
		500	PC	10	14	0.05 ❖	0.12
		600	N/A	-	-	-	-
	Hardened Steel	300 - 400	PC	15	29	0.10 ❖	0.15
400 - 500		PC	10	14	0.06 ❖	0.12	
K	Nodular, Grey, Ductile Cast Iron	120 - 150	HSS	52	84	0.20	0.30
		150 - 200	HSS	46	79	0.18	0.28
		200 - 220	HSS	40	68	0.15	0.23
		220 - 260	SC, PC	34	57	0.13	0.20
		260 - 320	SC, PC	27	47	0.13	0.18
N	Cast Aluminum	30	HSS	183	-	0.23	0.38
		180	HSS	91	-	0.20	0.33
	Wrought Aluminum	30	HSS	183	280	0.12	0.33
		180	HSS	91	200	0.12	0.18
	Aluminum Bronze	100 - 200	SC	52	82	0.15	0.24
		200 - 250	SC	40	65	0.12	0.18
	Brass	100	HSS	91	144	0.18	0.27
Copper	60	SC	40	58	0.07 ❖	0.10	

❖ Contact our Application Engineering department for assistance when machining these materials

**IMPORTANT:** The speeds and feeds listed above are a general starting point for all applications. Refer to the Coolant Recommendation charts for coolant requirements to run at the recommended speeds and feeds. Factory technical assistance is available through our Application Engineering department. See adjustment examples on the following page.



Feed Rate (mm/rev) by Diameter				
17.53 mm - 24.38 mm	24.41 mm - 35.00 mm	35.01 mm - 47.80 mm	47.85 mm - 65.99 mm	66.00 mm - 114.48 mm
0.41	0.48	0.51	0.58	0.71
0.38	0.43	0.51	0.58	0.71
0.36	0.41	0.51	0.58	0.71
0.36	0.46	0.48	0.58	0.69
0.36	0.43	0.48	0.58	0.69
0.33	0.41	0.46	0.53	0.61
0.33	0.41	0.46	0.53	0.61
0.36	0.43	0.48	0.58	0.69
0.33	0.41	0.46	0.53	0.61
0.33	0.41	0.46	0.53	0.61
0.30	0.38	0.41	0.48	0.56
0.36	0.43	0.43	0.48	0.56
0.33	0.41	0.43	0.48	0.56
0.33	0.41	0.43	0.48	0.56
0.30	0.38	0.38	0.43	0.51
0.28	0.36	0.38	0.43	0.51
0.28	0.33	0.36	0.43	0.51
0.25	0.30	0.36	0.43	0.51
0.23	0.28	0.30	0.41	0.46
0.38	0.43	0.46	0.53	0.66
0.33	0.38	0.41	0.48	0.61
0.30	0.33	0.36	0.43	0.51
0.25	0.30	0.30	0.38	0.43
0.25	0.30	0.30	0.38	0.43
0.23	0.28	0.30	0.38	-
0.20	0.25	0.25	0.30	-
0.21	0.27	0.30	0.38	-
0.18	0.23	0.25	0.30	-
0.23	0.28	0.36	0.41	0.51
0.20	0.25	0.30	0.36	0.46
0.23	0.28	0.36	0.41	0.51
0.20	0.25	0.30	0.36	0.46
0.23	0.28	0.36	0.41	0.51
0.20	0.25	0.30	0.36	0.46
0.20	0.23	0.30	0.41	0.46
0.18	0.20	0.25	0.30	0.40
-	-	-	-	-
0.23	0.27	0.30	0.41	0.46
0.18	0.24	0.25	0.30	0.40
0.41	0.51	0.61	0.69	0.76
0.38	0.48	0.56	0.64	0.71
0.33	0.43	0.46	0.53	0.61
0.28	0.36	0.36	0.43	0.51
0.25	0.28	0.28	0.36	0.41
0.46	0.58	0.56	0.64	0.64
0.40	0.50	0.56	0.64	0.64
0.40	0.50	0.56	0.64	0.64
0.30	0.35	0.56	0.64	0.64
0.30	0.38	0.43	0.48	0.53
0.23	0.28	0.36	0.40	0.46
0.33	0.45	0.47	0.53	0.58
0.18	0.26	0.23	0.27	0.31

**Deep Hole Drilling Speed and Feed Adjustment**

	Holder Length				
	Extended	Long	Long Plus	XL	3XL
Speed	0.90	0.85	0.80	0.80	0.75
Feed	-	0.95	0.90	0.90	0.90

**Recommended Speed and Feed Example**

If the recommended speed and feed is 50 M/min and 0.20 mm/rev for a standard length holder, then the speed and feed using a 3XL holder in the same application would be 37.5 M/min and 0.18 mm/rev.

$50 \cdot 0.75 = 37.5 \text{ M/min}$        $0.20 \cdot 0.90 = 0.18 \text{ mm/rev}$

**Formulas**

- RPM = (318.47 • M/min) / DIA**

where:  
 RPM = revolutions per minute (rev/min)  
 M/min = speed (M/min)  
 DIA = diameter of drill (mm)
- mm/min = RPM • mm/rev**

where:  
 mm/min = mm per minute (mm/min)  
 RPM = revolutions per minute (rev/min)  
 mm/rev = feed rate (mm/rev)
- M/min = RPM • 0.003 • DIA**

where:  
 M/min = speed (M/min)  
 RPM = revolutions per minute (rev/min)  
 DIA = diameter of drill (mm)

**⚠ WARNING** Tool failure can cause serious injury. To prevent:  
 - When using holders without support bushing, use a short T-A® holder to establish an initial hole that is a minimum of 2 diameters deep.  
 - Do not rotate tool holder more than 50 RPM unless it is engaged with the workpiece or fixture.  
 Visit [www.alliedmachine.com/DeepHoleGuidelines](http://www.alliedmachine.com/DeepHoleGuidelines) for the most up-to-date information and procedures. Factory technical assistance is available for your specific applications through our Application Engineering Team.

## GEN2 T-A® Recommended Drilling Data | Metric (mm)

### Carbide Inserts

ISO	Material	Hardness (BHN)	Carbide Grade	M/min  AM300®	Feed Rate (mm/rev) by Diameter			
					9.50 mm - 12.95 mm	12.98 mm - 17.53 mm	17.54 mm - 24.38 mm	24.41 mm - 35.00 mm
P	Free-Machining Steel 1118, 1215, 12L14, etc.	100 - 150	C1	146	0.20	0.30	0.41	0.48
		150 - 200	C1	126	0.18	0.28	0.38	0.43
		200 - 250	C1	119	0.15	0.25	0.36	0.41
	Low-Carbon Steel 1010, 1020, 1025, 1522, 1144, etc.	85 - 125	C1	137	0.20 ❖	0.25	0.36	0.46
		125 - 175	C1	119	0.18 ❖	0.25	0.36	0.43
		175 - 225	C1	108	0.15 ❖	0.23	0.33	0.41
	Medium-Carbon Steel 1030, 1040, 1050, 1527, 1140, 1151, etc.	225 - 275	C1	95	0.13 ❖	0.23	0.33	0.41
		125 - 175	C1	119	0.18	0.25	0.36	0.43
		175 - 225	C1	108	0.15	0.23	0.33	0.41
	Alloy Steel 4140, 5140, 8640, etc.	225 - 275	C1	95	0.15	0.23	0.33	0.41
		275 - 325	C1	80	0.13	0.20	0.30	0.38
		125 - 175	C1	115	0.18	0.25	0.36	0.43
175 - 225		C1	105	0.15	0.23	0.33	0.43	
225 - 275		C1	95	0.15	0.23	0.33	0.41	
High-Strength Alloy 4340, 4330V, 300M, etc.	275 - 325	C1	87	0.13	0.20	0.30	0.38	
	325 - 375	C1	78	0.10	0.18	0.28	0.36	
	225 - 300	C1	70	0.15 ❖	0.23	0.28	0.33	
Structural Steel A36, A285, A516, etc.	300 - 350	C1	63	0.13 ❖	0.20	0.25	0.30	
	350 - 400	C1	56	0.10 ❖	0.18	0.23	0.28	
	100 - 150	C1	108	0.20 ❖	0.28	0.38	0.43	
Tool Steel H-13, H-21, A-4, O-2, S-3, etc.	150 - 250	C1	87	0.15 ❖	0.25	0.33	0.38	
	250 - 350	C1	80	0.13 ❖	0.23	0.30	0.33	
	150 - 200	C1	78	0.10	0.18	0.25	0.30	
200 - 250	C1	59	0.10	0.18	0.25	0.30		
	S	High-Temp Alloy Hastelloy B, Inconel 600, etc.	140 - 220	C2	37	0.10 ❖	0.18	0.23
		220 - 310	C2	29	0.10 ❖	0.15	0.20	0.25
Titanium Alloy		140 - 220	C2	42	0.10 ❖	0.18	0.21	0.27
		220 - 310	C2	33	0.08 ❖	0.15	0.18	0.23
Aerospace Alloy S82		185 - 275	C2	73	0.12 ❖	0.16	0.18	0.22
	275 - 350	C2	56	0.10 ❖	0.14	0.16	0.19	
M	Stainless Steel 400 Series 416, 420, etc.	185 - 275	C2	73	0.18 ❖	0.23	0.30	0.36
		275 - 350	C2	56	0.15 ❖	0.20	0.28	0.30
	Stainless Steel 300 Series 304, 316, 17-4PH, etc.	135 - 185	C2	73	0.14 ❖	0.18	0.24	0.29
		185 - 275	C2	56	0.12 ❖	0.16	0.22	0.24
	Super Duplex Stainless Steel	135 - 185	C2	38	0.12 ❖	0.17	0.22	0.26
185 - 275		C2	30	0.10 ❖	0.15	0.18	0.22	

❖ Contact our Application Engineering department for assistance when machining these materials

**IMPORTANT:** The speeds and feeds listed above are a general starting point for all applications. Refer to the Coolant Recommendation charts for coolant requirements to run at the recommended speeds and feeds. Factory technical assistance is available through our Application Engineering department. See adjustment examples on the following page.

ISO	Material	Hardness (BHN)	Carbide Grade	M/min  AM300®	Feed Rate (mm/rev) by Diameter			
					9.50 mm - 12.95 mm	12.98 mm - 17.53 mm	17.54 mm - 24.38 mm	24.41 mm - 35.00 mm
H	Wear Plate Hardox®, AR400, T-1, etc.	400	C2	45	0.07 ❖	0.12	0.20	0.25
		500	C2	37	0.05 ❖	0.10	0.15	0.20
		600	C2	30	0.04 ❖	0.08	0.12	0.16
	Hardened Steel	300 - 400	C1	47	0.10 ❖	0.18	0.23	0.27
		400 - 500	C1	37	0.06 ❖	0.12	0.18	0.24
K	Nodular, Grey, Ductile Cast Iron	120 - 150	C2	152	0.20	0.30	0.38	0.48
		150 - 200	C2	146	0.18	0.28	0.33	0.43
		200 - 220	C2	131	0.15	0.23	0.30	0.38
		220 - 260	C2	113	0.13	0.20	0.28	0.33
		260 - 320	C2	102	0.13	0.18	0.25	0.28
N	Cast Aluminum	30	C2	300	0.23	0.38	0.46	0.58
		180	C2	225	0.20	0.33	0.40	0.50
	Wrought Aluminum	30	C2	426	0.12	0.33	0.40	0.50
		180	C2	300	0.12	0.18	0.30	0.35
	Aluminum Bronze	100 - 200	C2	110	0.15	0.24	0.30	0.38
		200 - 250	C2	90	0.12	0.18	0.23	0.28
	Brass	100	C2	200	0.18	0.27	0.33	0.45
Copper	60	C2	130	0.07 ❖	0.10	0.18	0.26	

❖ Contact our Application Engineering department for assistance when machining these materials

**Deep Hole Drilling Speed and Feed Adjustment**

	⚠ Holder Length				
	Extended	Long	Long Plus	XL	3XL
Speed	0.90	0.85	0.80	0.80	0.75
Feed	-	0.95	0.90	0.90	0.90

**Recommended Speed and Feed Example**

If the recommended speed and feed is 50 M/min and 0.20 mm/rev for a standard length holder, then the speed and feed using a 3XL holder in the same application would be 37.5 M/min and 0.18 mm/rev.

$50 \cdot 0.75 = 37.5 \text{ M/min}$	$0.20 \cdot 0.90 = 0.18 \text{ mm/rev}$
--------------------------------------	---

**Formulas**

1. $RPM = (318.47 \cdot M/min) / DIA$ where: RPM = revolutions per minute (rev/min) M/min = speed (M/min) DIA = diameter of drill (mm)	2. $mm/min = RPM \cdot mm/rev$ where: mm/min = mm per minute (mm/min) RPM = revolutions per minute (rev/min) mm/rev = feed rate (mm/rev)	3. $M/min = RPM \cdot 0.003 \cdot DIA$ where: M/min = speed (M/min) RPM = revolutions per minute (rev/min) DIA = diameter of drill (mm)
--	--	---



**⚠ WARNING** Tool failure can cause serious injury. To prevent:

- When using holders without support bushing, use a short T-A® holder to establish an initial hole that is a minimum of 2 diameters deep.
- Do not rotate tool holder more than 50 RPM unless it is engaged with the workpiece or fixture.

Visit [www.alliedmachine.com/DeepHoleGuidelines](http://www.alliedmachine.com/DeepHoleGuidelines) for the most up-to-date information and procedures. Factory technical assistance is available for your specific applications through our Application Engineering Team.

## T-A® Recommended Drilling Data | Metric (mm)

### HSS Inserts

ISO	Material	Hardness (BHN)	HSS Grade	M/min			Feed Rate (mm/rev) by Diameter	
				 TiN	 TiAlN	 TiCN	9.50 mm - 12.95 mm	12.98 mm - 17.52 mm
P	Free-Machining Steel 1118, 1215, 12L14, etc.	100 - 150	HSS	61	85	79	0.18	0.25
		150 - 200	HSS	55	79	72	0.18	0.25
		200 - 250	HSS	49	73	64	0.15	0.25
	Low-Carbon Steel 1010, 1020, 1025, 1522, 1144, etc.	85 - 125	HSS	52	76	67	0.15 ❖	0.23
		125 - 175	HSS	49	73	64	0.15 ❖	0.23
		175 - 225	HSS	46	69	59	0.13 ❖	0.20
	Medium-Carbon Steel 1030, 1040, 1050, 1527, 1140, 1151, etc.	225 - 275	HSS	43	64	55	0.13 ❖	0.20
		125 - 175	HSS	49	73	64	0.15	0.23
		175 - 225	HSS	46	69	59	0.13	0.20
	Alloy Steel 4140, 5140, 8640, etc.	225 - 275	HSS	43	64	55	0.13	0.20
		275 - 325	SC, PC	40	59	52	0.10	0.18
		275 - 325	SC, PC	37	52	47	0.10	0.15
325 - 375		SC, PC	34	47	44	0.08	0.15	
High-Strength Alloy 4340, 4330V, 300M, etc.	225 - 300	SC, PC	24	34	30	0.13 ❖	0.18	
	300 - 350	SC, PC	18	26	24	0.10 ❖	0.18	
	350 - 400	PC	15	21	20	0.08 ❖	0.15	
Structural Steel A36, A285, A516, etc.	100 - 150	HSS	43	61	55	0.15 ❖	0.25	
	150 - 250	HSS	37	52	47	0.13 ❖	0.23	
	250 - 350	SC, PC	30	43	40	0.10 ❖	0.20	
Tool Steel H-13, H-21, A-4, O-2, S-3, etc.	150 - 200	SC	24	34	32	0.10	0.15	
	200 - 250	SC, PC	18	27	26	0.10	0.15	
S	High-Temp Alloy Hastelloy B, Inconel 600, etc.	140 - 220	SC, PC	9	12	11	0.08 ❖	0.18
		220 - 310	PC	8	11	9	0.08 ❖	0.15
	Titanium Alloy	140 - 220	SC, PC	11	15	14	0.08 ❖	0.18
		220 - 310	PC	9	14	11	0.08 ❖	0.15
Aerospace Alloy S82	185 - 275	SC, PC	23	32	29	0.15 ❖	0.20	
	275 - 350	SC, PC	18	27	24	0.13 ❖	0.18	
M	Stainless Steel 400 Series 416, 420, etc.	185 - 275	SC, PC	23	32	29	0.15 ❖	0.20
		275 - 350	SC, PC	18	27	24	0.13 ❖	0.18
	Stainless Steel 300 Series 304, 316, 17-4PH, etc.	135 - 185	SC, PC	23	32	29	0.08 ❖	0.18
		185 - 275	SC, PC	18	27	24	0.08 ❖	0.15
	Super Duplex Stainless Steel	135 - 185	SC, PC	18	24	21	0.08 ❖	0.18
185 - 275		SC, PC	15	20	18	0.08 ❖	0.15	
H	Wear Plate Hardox®, AR400, T-1, etc.	400	SC, PC	14	21	17	0.08 ❖	0.15
		500	PC	11	14	12	0.05 ❖	0.13
		600	N/A	-	-	-	-	-
	Hardened Steel	300 - 400	PC	15	29	21	0.08 ❖	0.15
400 - 500		PC	11	14	12	0.05 ❖	0.13	
K	Nodular, Grey, Ductile Cast Iron	120 - 150	HSS	52	76	67	0.18	0.30
		150 - 200	HSS	46	69	59	0.15	0.28
		200 - 220	HSS	40	59	52	0.15	0.23
		220 - 260	SC, PC	34	50	44	0.13	0.18
		260 - 320	SC, PC	27	41	37	0.10	0.15
N	Cast Aluminum	30	HSS	183	259	229	0.20	0.33
		180	HSS	91	137	122	0.20	0.33
	Wrought Aluminum	30	HSS	183	259	229	0.10	0.15
		180	HSS	91	137	122	0.20	0.33
	Aluminum Bronze	100 - 200	SC	52	76	67	0.15	0.28
		200 - 250	SC	40	58	52	0.13	0.18
	Brass	100	HSS	91	136	122	0.18	0.30
Copper	60	SC	40	50	46	0.05 ❖	0.08	



❖ Contact our Application Engineering department for assistance when machining these materials

**IMPORTANT:** The speeds and feeds listed above are a general starting point for all applications. Refer to the Coolant Recommendation charts for coolant requirements to run at the recommended speeds and feeds. Factory technical assistance is available through our Application Engineering department. See adjustment examples on the following page.





## T-A® Recommended Drilling Data | Metric (mm)

### Carbide Inserts

ISO	Material	Hardness (BHN)	Carbide Grade	M/min			Feed Rate (mm/rev) by Diameter				
				 TiN	 TiAlN	 TiCN	9.50 mm - 12.95 mm	12.98 mm - 17.52 mm	17.53 mm - 24.38 mm	24.41 mm - 35.00 mm	35.01 mm - 47.80 mm
P	Free-Machining Steel 1118, 1215, 12L14, etc.	100 - 150	C5	96	128	115	0.20	0.30	0.38	0.45	0.53
		150 - 200	C5	85	110	100	0.18	0.28	0.35	0.40	0.48
		200 - 250	C5	79	104	90	0.15	0.25	0.33	0.38	0.43
	Low-Carbon Steel 1010, 1020, 1025, 1522, 1144, etc.	85 - 125	C5	91	119	110	0.20 ❖	0.25	0.33	0.43	0.48
		125 - 175	C5	79	104	90	0.18 ❖	0.25	0.33	0.40	0.45
		175 - 225	C5	73	95	82	0.15 ❖	0.23	0.30	0.38	0.43
	Medium-Carbon Steel 1030, 1040, 1050, 1527, 1140, 1151, etc.	125 - 175	C5	79	104	90	0.18	0.25	0.33	0.40	0.45
		175 - 225	C5	73	95	84	0.15	0.23	0.30	0.38	0.43
		225 - 275	C5	67	83	72	0.15	0.23	0.30	0.38	0.43
	Alloy Steel 4140, 5140, 8640, etc.	275 - 325	C5	55	70	62	0.13	0.20	0.28	0.35	0.40
		125 - 175	C5	76	99	87	0.18	0.25	0.33	0.40	0.45
		175 - 225	C5	70	92	80	0.15	0.23	0.30	0.38	0.43
225 - 275		C5	64	83	72	0.15	0.23	0.30	0.38	0.43	
275 - 325		C5	61	76	68	0.13	0.20	0.28	0.35	0.40	
High-Strength Alloy 4340, 4330V, 300M, etc.	325 - 375	C5	52	67	60	0.10	0.18	0.25	0.33	0.38	
	225 - 300	C5	49	61	55	0.15 ❖	0.23	0.25	0.30	0.38	
	300 - 350	C5	43	55	49	0.13 ❖	0.20	0.23	0.28	0.35	
Structural Steel A36, A285, A516, etc.	350 - 400	C5	37	49	43	0.10 ❖	0.18	0.20	0.25	0.30	
	100 - 150	C5	73	95	84	0.20 ❖	0.28	0.35	0.40	0.45	
	150 - 250	C5	61	76	68	0.15 ❖	0.25	0.30	0.35	0.40	
Tool Steel H-13, H-21, A-4, O-2, S-3, etc.	250 - 350	C5	55	70	62	0.13 ❖	0.23	0.28	0.30	0.35	
	150 - 200	C5	49	67	58	0.10	0.18	0.23	0.28	0.33	
200 - 250	C5	37	52	45	0.10	0.18	0.23	0.28	0.33		
	S	High-Temp Alloy Hastelloy B, Inconel 600, etc.	140 - 220	C2	24	32	28	0.10 ❖	0.18	0.23	0.28
220 - 310		C2	18	26	22	0.10 ❖	0.15	0.20	0.25	0.30	
Titanium Alloy		140 - 220	C2	30	38	32	0.10 ❖	0.18	0.23	0.28	0.33
		220 - 310	C2	24	33	28	0.10 ❖	0.15	0.20	0.25	0.30
Aerospace Alloy S82		185 - 275	C2	49	64	57	0.17 ❖	0.22	0.29	0.35	0.40
	275 - 350	C2	37	49	43	0.14 ❖	0.19	0.27	0.30	0.35	
M	Stainless Steel 400 Series 416, 420, etc.	185 - 275	C2	49	64	57	0.17 ❖	0.22	0.29	0.35	0.40
		275 - 350	C2	37	49	43	0.14 ❖	0.19	0.27	0.30	0.35
	Stainless Steel 300 Series 304, 316, 17-4PH, etc.	135 - 185	C2	49	64	57	0.13 ❖	0.17	0.22	0.26	0.30
		185 - 275	C2	37	49	43	0.11 ❖	0.14	0.20	0.22	0.25
	Super Duplex Stainless Steel	135 - 185	C2	25	33	29	0.11 ❖	0.15	0.19	0.23	0.27
185 - 275		C2	19	25	22	0.09 ❖	0.13	0.18	0.20	0.23	

❖ Contact our Application Engineering department for assistance when machining these materials

**IMPORTANT:** The speeds and feeds listed above are a general starting point for all applications. Refer to the Coolant Recommendation charts for coolant requirements to run at the recommended speeds and feeds. Factory technical assistance is available through our Application Engineering department. See adjustment examples on the following page.

ISO	Material	Hardness (BHN)	Carbide Grade	M/min			Feed Rate (mm/rev) by Diameter				
				 TiN	 TiAlN	 TiCN	9.50 mm - 12.95 mm	12.98 mm - 17.52 mm	17.53 mm - 24.38 mm	24.41 mm - 35.00 mm	35.01 mm - 47.80 mm
H	Wear Plate Hardox®, AR400, T-1, etc.	400	C5	23	35	30	0.07	0.12	0.20	0.25	0.30
		500	C5	15	26	21	0.05	0.10	0.15	0.20	0.25
		600	C5	11	22	16	0.04	0.08	0.12	0.16	0.20
	Hardened Steel	300 - 400	C5	34	43	39	0.10 ❖	0.18	0.23	0.28	0.33
400 - 500		C5	20	25	23	0.08 ❖	0.15	0.20	0.23	0.28	
K	Nodular, Grey, Ductile Cast Iron	120 - 150	C2, C3	98	141	127	0.20	0.30	0.38	0.48	0.58
		150 - 200	C2, C3	82	122	102	0.18	0.28	0.33	0.43	0.53
		200 - 220	C2, C3	73	110	93	0.15	0.23	0.30	0.38	0.45
		220 - 260	C2, C3	64	95	79	0.13	0.20	0.28	0.33	0.38
		260 - 320	C2, C3	55	83	69	0.13	0.18	0.25	0.28	0.33
N	Cast Aluminum	30	C2	366	460	410	0.25	0.38	0.45	0.50	0.55
		180	C2	244	306	275	0.23	0.33	0.40	0.45	0.50
	Wrought Aluminum	30	C2	366	460	410	0.10	0.15	0.25	0.30	0.36
		180	C2	244	306	275	0.20	0.28	0.36	0.45	0.50
	Aluminum Bronze	100 - 200	C2	85	110	100	0.13	0.20	0.25	0.36	0.42
		200 - 250	C2	64	94	79	0.10	0.15	0.18	0.25	0.33
	Brass	100	C2	130	184	160	0.15	0.23	0.28	0.38	0.45
Copper	60	C2	80	120	100	0.05 ❖	0.08	0.10	0.15	0.25	

❖ Contact our Application Engineering department for assistance when machining these materials

**Deep Hole Drilling Speed and Feed Adjustment**

	⚠ Holder Length				
	Extended	Long	Long Plus	XL	3XL
Speed	0.90	0.85	0.80	0.80	0.75
Feed	-	0.95	0.90	0.90	0.90

**Recommended Speed and Feed Example**

If the recommended speed and feed is 50 M/min and 0.20 mm/rev for a standard length holder, then the speed and feed using a 3XL holder in the same application would be 37.5 M/min and 0.18 mm/rev.

$50 \cdot 0.75 = 37.5 \text{ M/min}$	$0.20 \cdot 0.90 = 0.18 \text{ mm/rev}$
--------------------------------------	---

**Formulas**

1. $RPM = (318.47 \cdot M/min) / DIA$ where: RPM = revolutions per minute (rev/min) M/min = speed (M/min) DIA = diameter of drill (mm)	2. $mm/min = RPM \cdot mm/rev$ where: mm/min = mm per minute (mm/min) RPM = revolutions per minute (rev/min) mm/rev = feed rate (mm/rev)	3. $M/min = RPM \cdot 0.003 \cdot DIA$ where: M/min = speed (M/min) RPM = revolutions per minute (rev/min) DIA = diameter of drill (mm)
--	--	---





**⚠ WARNING** Tool failure can cause serious injury. To prevent:

- When using holders without support bushing, use a short T-A® holder to establish an initial hole that is a minimum of 2 diameters deep.
- Do not rotate tool holder more than 50 RPM unless it is engaged with the workpiece or fixture.

Visit [www.alliedmachine.com/DeepHoleGuidelines](http://www.alliedmachine.com/DeepHoleGuidelines) for the most up-to-date information and procedures. Factory technical assistance is available for your specific applications through our Application Engineering Team.

## T-A® Recommended Drilling Data | Metric (mm)

HSS Inserts | Flat Bottom Geometry

ISO	Material	Hardness (BHN)	HSS Grade	M/min			
				 TiN	 TiAlN	 TiCN	 AM200®
P	Free-Machining Steel 1118, 1215, 12L14, etc.	100 - 150	HSS	52	76	70	88
		150 - 200	HSS	47	70	62	81
		200 - 250	HSS	43	64	56	74
	Low-Carbon Steel 1010, 1020, 1025, 1522, 1144, etc.	85 - 125	HSS	46	67	59	77
		125 - 175	HSS	43	64	56	74
		175 - 225	HSS	40	59	53	68
		225 - 275	HSS	37	56	47	65
	Medium-Carbon Steel 1030, 1040, 1050, 1527, 1140, 1151, etc.	125 - 175	HSS	43	64	56	74
		175 - 225	HSS	40	59	53	68
		225 - 275	HSS	37	56	47	65
		275 - 325	SC	34	53	46	61
	Alloy Steel 4140, 5140, 8640, etc.	125 - 175	HSS	40	56	53	65
175 - 225		HSS	37	53	47	61	
225 - 275		HSS	34	47	44	54	
275 - 325		SC	32	44	41	51	
325 - 375		SC	29	41	38	47	
High-Strength Alloy 4340, 4330V, 300M, etc.	225 - 300	SC	21	29	26	33	
	300 - 350	SC	15	23	21	27	
	350 - 400	SC	13	20	18	23	
Structural Steel A36, A285, A516, etc.	100 - 150	HSS	36	52	47	60	
	150 - 250	HSS	32	44	41	51	
	250 - 350	SC	26	37	34	43	
Tool Steel H-13, H-21, A-4, O-2, S-3, etc.	150 - 200	SC	21	29	27	33	
	200 - 250	SC	15	24	23	28	
S	High-Temp Alloy Hastelloy B, Inconel 600, etc.	140 - 220	SC	7	10	9	13
		220 - 310	SC	6	9	7	10
	Titanium Alloy	140 - 220	SC	10	14	12	16
		220 - 310	SC	8	12	11	14
	Aerospace Alloy S82	185 - 275	SC	20	27	26	34
275 - 350	SC	15	24	21	28		
M	Stainless Steel 400 Series 416, 420, etc.	185 - 275	SC	20	27	26	34
		275 - 350	SC	15	24	21	28
	Stainless Steel 300 Series 304, 316, 17-4PH, etc.	135 - 185	SC	20	27	26	34
		185 - 275	SC	15	24	21	28
	Super Duplex Stainless Steel	135 - 185	SC	20	27	26	34
185 - 275	SC	15	24	21	28		
H	Wear Plate Hardox®, AR400, T-1, etc.	400	SC	-	-	-	-
		500	SC	-	-	-	-
		600	N/A	-	-	-	-
	Hardened Steel	300 - 400	SC	13	20	18	24
400 - 500		SC	8	12	10	13	
K	Nodular, Grey, Ductile Cast Iron	120 - 150	HSS	46	67	59	77
		150 - 200	HSS	40	59	53	68
		200 - 220	HSS	34	53	46	61
		220 - 260	SC	29	46	38	53
		260 - 320	SC	24	37	32	43
N	Cast Aluminum	30	HSS	160	228	198	-
		180	HSS	79	122	107	-
	Wrought Aluminum	30	HSS	160	228	198	261
		180	HSS	79	122	107	141
	Aluminum Bronze	100 - 200	SC	40	59	53	70
		200 - 250	SC	29	46	38	50
Brass	100	HSS	46	67	59	78	
Copper	60	SC	35	45	40	53	

❖ Contact our Application Engineering department for assistance when machining these materials

**IMPORTANT:** The speeds and feeds listed above are a general starting point for all applications. Refer to the Coolant Recommendation charts for coolant requirements to run at the recommended speeds and feeds. Factory technical assistance is available through our Application Engineering department. See adjustment examples on the following page.



Feed Rate (mm/rev) by Diameter					
9.50 mm - 12.95 mm	12.98 mm - 17.53 mm	17.53 mm - 24.38 mm	24.21 mm - 35.00 mm	35.01 mm - 47.80 mm	47.85 mm - 65.99 mm
0.15	0.23	0.28	0.35	0.41	0.46
0.15	0.23	0.28	0.35	0.41	0.46
0.13	0.23	0.28	0.35	0.38	0.43
0.13 ❖	0.20	0.25	0.33	0.38	0.43
0.13 ❖	0.20	0.25	0.33	0.38	0.41
0.10 ❖	0.18	0.23	0.30	0.36	0.41
0.10 ❖	0.18	0.23	0.30	0.36	0.38
0.13	0.20	0.25	0.33	0.38	0.46
0.10	0.18	0.23	0.30	0.36	0.43
0.10	0.18	0.23	0.30	0.36	0.43
0.10	0.15	0.20	0.25	0.33	0.38
0.13	0.18	0.23	0.30	0.33	0.41
0.10	0.18	0.23	0.30	0.33	0.41
0.10	0.15	0.23	0.30	0.33	0.41
0.10	0.13	0.20	0.25	0.30	0.38
0.08	0.13	0.20	0.25	0.30	0.36
0.10 ❖	0.15	0.20	0.23	0.25	0.30
0.08 ❖	0.15	0.20	0.23	0.25	0.30
0.08 ❖	0.13	0.18	0.20	0.23	0.28
0.13 ❖	0.23	0.25	0.30	0.38	0.43
0.10 ❖	0.20	0.23	0.25	0.33	0.41
0.10 ❖	0.18	0.20	0.23	0.30	0.38
0.10	0.13	0.18	0.23	0.25	0.30
0.10	0.13	0.18	0.23	0.23	0.28
0.08 ❖	0.15	0.18	0.23	0.25	0.30
0.08 ❖	0.13	0.15	0.18	0.20	0.25
0.08 ❖	0.15	0.18	0.23	0.25	0.30
0.08 ❖	0.13	0.15	0.18	0.20	0.25
0.13 ❖	0.18	0.20	0.25	0.30	0.38
0.10 ❖	0.15	0.18	0.23	0.25	0.30
0.13 ❖	0.18	0.20	0.25	0.30	0.36
0.10 ❖	0.15	0.18	0.23	0.25	0.28
0.13 ❖	0.18	0.20	0.25	0.30	0.36
0.10 ❖	0.15	0.18	0.23	0.25	0.28
-	-	-	-	-	-
-	-	-	-	-	-
-	-	-	-	-	-
0.08 ❖	0.13	0.18	0.20	0.27	0.38
0.06 ❖	0.10	0.15	0.18	0.23	0.28
0.15	0.25	0.36	0.43	0.48	0.51
0.13	0.23	0.30	0.41	0.46	0.48
0.13	0.20	0.25	0.36	0.41	0.43
0.10	0.15	0.20	0.25	0.33	0.33
0.10	0.13	0.15	0.20	0.25	0.25
0.18	0.28	0.36	0.43	0.46	0.48
0.18	0.28	0.36	0.41	0.43	0.48
0.18	0.28	0.36	0.43	0.46	0.48
0.18	0.28	0.36	0.41	0.43	0.48
0.13	0.23	0.30	0.41	0.51	0.61
0.10	0.15	0.20	0.25	0.31	0.38
0.15	0.25	0.36	0.43	0.53	0.63
0.05 ❖	0.08	0.15	0.20	0.25	0.35

Deep Hole Drilling Speed and Feed Adjustment

	Holder Length				
	Extended	Long	Long Plus	XL	3XL
Speed	0.90	0.85	0.80	0.80	0.75
Feed	-	0.95	0.90	0.90	0.90

Recommended Speed and Feed Example

If the recommended speed and feed is 50 M/min and 0.20 mm/rev for a standard length holder, then the speed and feed using a 3XL holder in the same application would be 37.5 M/min and 0.18 mm/rev.

$50 \cdot 0.75 = 37.5 \text{ M/min}$        $0.20 \cdot 0.90 = 0.18 \text{ mm/rev}$

Formulas

- RPM = (318.47 • M/min) / DIA**

where:  
 RPM = revolutions per minute (rev/min)  
 M/min = speed (M/min)  
 DIA = diameter of drill (mm)
- mm/min = RPM • mm/rev**





where:  
 mm/min = mm per minute (mm/min)  
 RPM = revolutions per minute (rev/min)  
 mm/rev = feed rate (mm/rev)
- M/min = RPM • 0.003 • DIA**

where:  
 M/min = speed (M/min)  
 RPM = revolutions per minute (rev/min)  
 DIA = diameter of drill (mm)

**⚠ WARNING** Tool failure can cause serious injury. To prevent:  
 - When using holders without support bushing, use a short T-A® holder to establish an initial hole that is a minimum of 2 diameters deep.  
 - Do not rotate tool holder more than 50 RPM unless it is engaged with the workpiece or fixture.  
 Visit [www.alliedmachine.com/DeepHoleGuidelines](http://www.alliedmachine.com/DeepHoleGuidelines) for the most up-to-date information and procedures. Factory technical assistance is available for your specific applications through our Application Engineering Team.





## T-A® Recommended Drilling Data | Metric (mm)

Carbide Inserts | Flat Bottom Geometry

ISO	Material	Hardness (BHN)	Carbide Grade	M/min				Feed Rate (mm/rev) by Diameter			
				 TiN	 TiAlN	 TiCN	 AM200®	9.50 mm - 12.95 mm	12.98 mm - 17.53 mm	17.54 mm - 24.38 mm	24.41 mm - 35.00 mm
P	Free-Machining Steel 1118, 1215, 12L14, etc.	100 - 150	C2	82	110	98	126	0.17	0.26	0.32	0.39
		150 - 200	C2	73	94	85	110	0.15	0.24	0.30	0.35
		200 - 250	C2	67	88	76	102	0.13	0.22	0.28	0.32
	Low-Carbon Steel 1010, 1020, 1025, 1522, 1144, etc.	85 - 125	C2	79	102	94	117	0.17 ❖	0.22	0.28	0.37
		125 - 175	C2	67	88	76	102	0.15 ❖	0.22	0.28	0.35
		175 - 225	C2	61	81	70	93	0.13 ❖	0.19	0.26	0.32
	Medium-Carbon Steel 1030, 1040, 1050, 1527, 1140, 1151, etc.	125 - 175	C2	67	88	76	102	0.15	0.22	0.28	0.35
		175 - 225	C2	61	81	72	93	0.13	0.19	0.26	0.32
		225 - 275	C2	55	70	61	81	0.13	0.19	0.26	0.32
	Alloy Steel 4140, 5140, 8640, etc.	275 - 325	C2	46	61	53	70	0.11	0.17	0.24	0.30
		125 - 175	C2	64	85	75	99	0.15	0.22	0.28	0.35
		175 - 225	C2	59	79	67	91	0.13	0.19	0.26	0.32
225 - 275		C2	55	70	61	81	0.13	0.19	0.26	0.32	
275 - 325		C2	52	66	58	76	0.11	0.17	0.24	0.30	
High-Strength Alloy 4340, 4330V, 300M, etc.	325 - 375	C2	44	58	50	67	0.09	0.15	0.22	0.28	
	225 - 300	C2	41	52	47	59	0.13 ❖	0.19	0.22	0.26	
	300 - 350	C2	37	47	41	55	0.11 ❖	0.17	0.19	0.24	
Structural Steel A36, A285, A516, etc.	350 - 400	C2	30	41	37	47	0.09 ❖	0.15	0.17	0.22	
	100 - 150	C2	62	81	72	93	0.17 ❖	0.24	0.30	0.35	
	150 - 250	C2	52	66	58	76	0.13 ❖	0.22	0.28	0.30	
Tool Steel H-13, H-21, A-4, O-2, S-3, etc.	250 - 350	C2	47	61	53	70	0.11 ❖	0.19	0.25	0.26	
	150 - 200	C2	41	58	49	67	0.09	0.15	0.19	0.24	
S	High-Temp Alloy Hastelloy B, Inconel 600, etc.	200 - 250	C2	30	44	37	50	0.09	0.15	0.19	0.24
		140 - 220	C2	21	27	23	32	0.09 ❖	0.15	0.19	0.24
S	Titanium Alloy	220 - 310	C2	15	21	18	24	0.09 ❖	0.13	0.17	0.22
		140 - 220	C2	26	33	28	40	0.08 ❖	0.14	0.17	0.20
	Aerospace Alloy S82	220 - 310	C2	21	29	25	30	0.08 ❖	0.12	0.15	0.18
		185 - 275	C2	43	37	50	40	0.15 ❖	0.17	0.25	0.30
M	Stainless Steel 400 Series 416, 420, etc.	275 - 350	C2	33	43	38	49	0.13 ❖	0.18	0.23	0.25
		185 - 275	C2	43	56	50	64	0.15 ❖	0.20	0.25	0.30
	Stainless Steel 300 Series 304, 316, 17-4PH, etc.	135 - 185	C2	28	37	33	40	0.13 ❖	0.17	0.21	0.25
		185 - 275	C2	21	28	25	32	0.11 ❖	0.15	0.19	0.21
	Super Duplex Stainless Steel	135 - 185	C2	22	29	26	33	0.10 ❖	0.14	0.17	0.20
		185 - 275	C2	17	22	19	26	0.08 ❖	0.12	0.15	0.17

❖ Contact our Application Engineering department for assistance when machining these materials

**IMPORTANT:** The speeds and feeds listed above are a general starting point for all applications. Refer to the Coolant Recommendation charts for coolant requirements to run at the recommended speeds and feeds. Factory technical assistance is available through our Application Engineering department. See adjustment examples on the following page.

ISO	Material	Hardness (BHN)	Carbide Grade	M/min				Feed Rate (mm/rev) by Diameter			
				 TiN	 TiAlN	 TiCN	 AM200®	9.50 mm - 12.95 mm	12.98 mm - 17.53 mm	17.54 mm - 24.38 mm	24.41 mm - 35.00 mm
H	Wear Plate Hardox®, AR400, T-1, etc.	400	C2	20	31	26	39	0.06 ❖	0.10	0.16	0.20
		500	C2	13	23	18	31	0.04 ❖	0.08	0.12	0.16
		600	C2	10	19	14	25	0.03 ❖	0.06	0.10	0.13
	Hardened Steel	300 - 400	C2	30	38	34	41	0.08 ❖	0.14	0.18	0.22
400 - 500		C2	18	22	20	33	0.06 ❖	0.12	0.16	0.18	
K	Nodular, Grey, Ductile Cast Iron	120 - 150	C2	82	120	108	137	0.17	0.26	0.32	0.41
		150 - 200	C2	70	104	87	119	0.15	0.24	0.28	0.38
		200 - 220	C2	61	94	79	108	0.13	0.19	0.26	0.32
		220 - 260	C2	55	81	67	93	0.11	0.17	0.24	0.28
		260 - 320	C2	47	70	58	81	0.11	0.15	0.22	0.24
N	Cast Aluminum	30	C2	160	228	198	-	0.22	0.32	0.41	0.43
		180	C2	79	122	107	-	0.19	0.28	0.35	0.39
	Wrought Aluminum	30	C2	292	368	328	390	0.12	0.18	0.23	0.25
		180	C2	195	245	220	260	0.10	0.16	0.20	0.22
	Aluminum Bronze	100 - 200	C2	73	95	85	105	0.10	0.16	0.20	0.29
		200 - 250	C2	55	81	68	87	0.08	0.12	0.14	0.20
	Brass	100	C2	112	160	138	185	0.12	0.18	0.22	0.30
Copper	60	C2	68	105	85	117	0.04 ❖	0.06	0.08	0.12	

❖ Contact our Application Engineering department for assistance when machining these materials

**Deep Hole Drilling Speed and Feed Adjustment**

	⚠ Holder Length				
	Extended	Long	Long Plus	XL	3XL
Speed	0.90	0.85	0.80	0.80	0.75
Feed	-	0.95	0.90	0.90	0.90

**Recommended Speed and Feed Example**

If the recommended speed and feed is 50 M/min and 0.20 mm/rev for a standard length holder, then the speed and feed using a 3XL holder in the same application would be 37.5 M/min and 0.18 mm/rev.

$50 \cdot 0.75 = 37.5 \text{ M/min}$	$0.20 \cdot 0.90 = 0.18 \text{ mm/rev}$
--------------------------------------	---

**Formulas**

1. $RPM = (318.47 \cdot M/min) / DIA$ where: RPM = revolutions per minute (rev/min) M/min = speed (M/min) DIA = diameter of drill (mm)	2. $mm/min = RPM \cdot mm/rev$ where: mm/min = mm per minute (mm/min) RPM = revolutions per minute (rev/min) mm/rev = feed rate (mm/rev)	3. $M/min = RPM \cdot 0.003 \cdot DIA$ where: M/min = speed (M/min) RPM = revolutions per minute (rev/min) DIA = diameter of drill (mm)
--	--	---

**⚠ WARNING** Tool failure can cause serious injury. To prevent:  
 - When using holders without support bushing, use a short T-A® holder to establish an initial hole that is a minimum of 2 diameters deep.  
 - Do not rotate tool holder more than 50 RPM unless it is engaged with the workpiece or fixture.  
 Visit [www.alliedmachine.com/DeepHoleGuidelines](http://www.alliedmachine.com/DeepHoleGuidelines) for the most up-to-date information and procedures. Factory technical assistance is available for your specific applications through our Application Engineering Team.

## T-A® Recommended Drilling Data | Metric (mm)

Carbide Inserts | Diamond Coating

Material	Carbide Grade	M/min  Diamond Coating	Feed Rate (mm/rev) by Diameter				
			9.5 mm - 12.5 mm	13 mm - 17.5 mm	18 mm - 24 mm	25 mm - 35 mm	
Polymer Matrix Composites	Carbon (hard)	N2	305 - 450	0.10 - 0.15	0.20 - 0.25	0.25 - 0.30	0.30 - 0.36
	Carbon Fiber	N2	305 - 450	0.10 - 0.15	0.20 - 0.25	0.25 - 0.30	0.30 - 0.36
	Carbon / Glass Fiber	N2	305 - 450	0.10 - 0.15	0.20 - 0.25	0.25 - 0.30	0.30 - 0.36
	Fiberglass	N2	305 - 450	0.10 - 0.15	0.20 - 0.25	0.25 - 0.30	0.30 - 0.36
	Graphite	N2	305 - 450	0.10 - 0.15	0.20 - 0.25	0.25 - 0.30	0.30 - 0.36
	Plastics	N2	76 - 305	0.10 - 0.15	0.20 - 0.25	0.25 - 0.30	0.30 - 0.36
	Epoxy Resin	N2	76 - 305	0.10 - 0.15	0.20 - 0.25	0.25 - 0.30	0.30 - 0.36
	Bismaleimide Resin	N2	76 - 305	0.10 - 0.15	0.20 - 0.25	0.25 - 0.30	0.30 - 0.36
	Polyester Resin	N2	76 - 305	0.10 - 0.15	0.20 - 0.25	0.25 - 0.30	0.30 - 0.36
	Phenolic Resin	N2	76 - 305	0.10 - 0.15	0.20 - 0.25	0.25 - 0.30	0.30 - 0.36
Rubber	N2	76 - 305	0.10 - 0.15	0.20 - 0.25	0.25 - 0.30	0.30 - 0.36	
Metal Matrix Composites	Aluminum	N2	305	0.20	0.33	0.41	0.51
	Si < 10%	N2	305	0.20	0.33	0.41	0.51
	10% < Si < 15%	N2	259 - 305	0.20	0.33	0.41	0.51
	15% < Si < 20%	N2	198 - 259	0.20	0.33	0.41	0.51
	20% < Si < 25%	N2	152 - 198	0.20	0.33	0.41	0.51
	25% < Si	N2	61 - 152	0.20	0.33	0.41	0.51
	Brass	N2	76 - 152	0.20	0.33	0.41	0.51
	Bronze	N2	76 - 152	0.20	0.33	0.41	0.51
	Copper	N2	30 - 76	0.10 - 0.15	0.20 - 0.25	0.25 - 0.30	0.30 - 0.36
	Copper Alloys	N2	30 - 76	0.10 - 0.15	0.20 - 0.25	0.25 - 0.30	0.30 - 0.36
	Lead Alloys	N2	30 - 76	0.10 - 0.15	0.20 - 0.25	0.25 - 0.30	0.30 - 0.36
	Magnesium Alloys	N2	30 - 76	0.10 - 0.15	0.20 - 0.25	0.25 - 0.30	0.30 - 0.36
Precious Metals	N2	30 - 76	0.10 - 0.15	0.20 - 0.25	0.25 - 0.30	0.30 - 0.36	
Ceramic Matrix Composites	Carbide (green)	N2	15 - 76	0.10 - 0.15	0.20 - 0.25	0.25 - 0.30	0.30 - 0.36
	Ceramic (green)	N2	15 - 76	0.10 - 0.15	0.20 - 0.25	0.25 - 0.30	0.30 - 0.36
	Ceramic (pre-sintered)	N2	15 - 76	0.10 - 0.15	0.20 - 0.25	0.25 - 0.30	0.30 - 0.36

### Deep Hole Drilling Speed and Feed Adjustment

	Holder Length				
	Extended	Long	Long Plus	XL	3XL
Speed	0.90	0.85	0.80	0.80	0.75
Feed	-	0.95	0.90	0.90	0.90

### Recommended Speed and Feed Example

If the recommended speed and feed is 50 M/min and 0.20 mm/rev for a standard length holder, then the speed and feed using a 3XL holder in the same application would be 37.5 M/min and 0.18 mm/rev.

$$50 \cdot 0.75 = 37.5 \text{ M/min}$$

$$0.20 \cdot 0.90 = 0.18 \text{ mm/rev}$$

#### **⚠ WARNING** Tool failure can cause serious injury. To prevent:

- When using holders without support bushing, use a short T-A® holder to establish an initial hole that is a minimum of 2 diameters deep.
- Do not rotate tool holder more than 50 RPM unless it is engaged with the workpiece or fixture.

Visit [www.alliedmachine.com/DeepHoleGuidelines](http://www.alliedmachine.com/DeepHoleGuidelines) for the most up-to-date information and procedures. Factory technical assistance is available for your specific applications through our Application Engineering Team.

**IMPORTANT:** The speeds and feeds listed above are a general starting point for all applications. Refer to the Coolant Recommendation charts for coolant requirements to run at the recommended speeds and feeds. Factory technical assistance is available through our Application Engineering department. See adjustment examples on the following page.

## Tap Drill Information and Formulas | Metric (mm)

### Metric Profile Screw Thread

Tap Size	Tap Drill Size	Decimal Equivalent	* Theo % Thread	Probable Mean Oversize	Probable Hole Size	** Probable % Thread
12 x 1.75	10.2 mm	0.4016"	79%	0.075 mm	10.28 mm	76%
12 x 1.75	13/32"	0.4063"	74%	0.075 mm	10.40 mm	71%
12 x 1.25	27/64"	0.4219"	79%	0.075 mm	10.79 mm	74%
12 x 1.25	10.8 mm	0.4252"	74%	0.075 mm	10.88 mm	69%
14 x 20	15/32"	0.4688"	81%	0.075 mm	11.98 mm	78%
14 x 20	12.0 mm	0.4724"	77%	0.075 mm	12.08 mm	74%
14 x 1.5	12.5 mm	0.4921"	77%	0.075 mm	12.58 mm	73%
16 x 2.0	14.0 mm	0.5512"	77%	0.075 mm	14.08 mm	74%
16 x 1.5	14.5 mm	0.5709"	77%	0.075 mm	14.58 mm	73%
16 x 1.5	37/64"	0.5781"	68%	0.075 mm	14.76 mm	64%
18 x 2.5	15.5 mm	0.6102"	77%	0.075 mm	15.58 mm	75%
18 x 1.5	16.5 mm	0.6496"	77%	0.075 mm	16.58 mm	73%
18 x 1.5	21/32"	0.6563"	68%	0.075 mm	16.75 mm	64%
20 x 2.5	11/16"	0.6875"	78%	0.075 mm	17.54 mm	76%
20 x 2.5	17.5 mm	0.6890"	77%	0.075 mm	17.58 mm	74%
20 x 1.5	18.5 mm	0.7283"	77%	0.075 mm	18.58 mm	73%
20 x 1.5	47/64"	0.7344"	69%	0.075 mm	18.66 mm	65%
22 x 2.5	49/64"	0.7656"	79%	0.075 mm	19.52 mm	76%
22 x 2.5	19.5 mm	0.7677"	77%	0.075 mm	19.58 mm	75%
22 x 1.5	20.5 mm	0.8071"	77%	0.075 mm	20.58 mm	73%
22 x 1.5	13/16"	0.8125"	70%	0.075 mm	20.71 mm	66%
24 x 3	13/16"	0.8125"	86%	0.075 mm	20.71 mm	84%
24 x 3	21.0 mm	0.8268"	76%	0.075 mm	21.08 mm	75%
24 x 2	22.0 mm	0.8661"	77%	0.075 mm	22.08 mm	74%
24 x 2	7/8"	0.8750"	68%	0.075 mm	22.30 mm	65%
27 x 3	24.0 mm	0.9449"	77%	0.075 mm	24.08 mm	75%

### Taper Pipe Thread (NPT)

Tap Size	Tap Drill Size	Decimal Equivalent	Theo % Thread*	Probable Mean Oversize	Probable Hole Size	Probable % Thread**
1/4 - 18	7/16	0.4375	-	0.075 mm	11.19 mm	-
3/8 - 18	9/16	0.5625	-	0.075 mm	14.76 mm	-
1/2 - 14	45/64	0.7031	-	0.075 mm	18.33 mm	-
3/4 - 14	29/32	0.9063	-	0.075 mm	23.89 mm	-

\* Based on nominal tap drill diameter

\*\* Based on 0.075 mm probable mean oversize

To calculate the percent of full thread for a given hole diameter:

$$\% \text{ Thread} = \left[ \frac{76.93}{\text{Pitch (mm)}} \right] \left[ \text{Basic Major Diameter of Thread (mm)} - \text{Drill Hole Size (mm)} \right]$$

### Notes

- The above tap drill information represents probable thread percentages for the standard tap drills stocked at Allied Machine. Special insert diameters may be required in order to meet a user specific percentage of thread requirements.
- The 0.075 mm probable mean oversize hole condition is based on optimum cutting conditions. Probable percent of full thread may vary based on less ideal cutting conditions.
- The table and equations on this page are found in the *Machinery's Handbook*. Permission to simplify and print the equations is granted by the editor of the *Machinery's Handbook*.

### Formulas

1.	<b>RPM</b> = (318.47 • M/min) / DIA <i>where:</i> RPM = revolutions per minute (rev/min) M/min = speed (M/min) DIA = diameter of drill (mm)
2.	<b>mm/min</b> = RPM • mm/rev <i>where:</i> mm/min = mm per minute (mm/min) RPM = revolutions per minute (rev/min) mm/rev = feed rate (mm/rev)
3.	<b>M/min</b> = RPM • 0.003 • DIA <i>where:</i> M/min = speed (M/min) RPM = revolutions per minute (rev/min) DIA = diameter of drill (mm)
4.	<b>Thrust</b> = 154 • (mm/rev) • DIA • K <sub>m</sub> <i>where:</i> Thrust = axial thrust (N) mm/rev = feed rate (mm/rev) DIA = diameter of drill (mm) K <sub>m</sub> = specific cutting energy (kPa)
5.	<b>Tool Power</b> = ((mm/rev) • RPM • K <sub>m</sub> • DIA <sup>2</sup> ) / 210604.8 <i>where:</i> Tool Power = tool power (HP) mm/rev = feed rate (mm/rev) RPM = revolutions per minute (rev/min) K <sub>m</sub> = specific cutting energy (kPa) DIA = diameter of drill (mm)

### Material Constants

Type of Material	Hardness	K <sub>m</sub> (kPa)
Plain Carbon and Alloy Steel	85 - 200 BHN	5.45
	200 - 275 BHN	6.48
	275 - 375 BHN	6.89
	375 - 425 BHN	7.93
High-Temperature Alloys	-	9.93
Stainless Steels	135 - 275 BHN	6.48
	30 - 45 RC	7.45
Cast Iron	100 - 200 BHN	3.45
	200 - 300 BHN	7.45
Copper Alloy	20 - 80 RB	2.96
	80 - 100 RB	4.96
Titanium Alloy	-	4.96
Aluminum Alloy	-	1.52
Magnesium Alloy	-	1.10

## Coolant Recommendations | Metric (mm)

### HSS Drill Inserts

ISO	Material	Pressure or Flow Rate	9.5 mm - 12.5 mm	13 mm - 17 mm	18 mm - 24 mm	25 mm - 35 mm	36mm - 50 mm	51 mm - 76 mm	76 mm - 102 mm
P	Free-Machining Steel 1118, 1215, 12L14, etc.	BAR	12 - 13	7 - 8	7 - 10	6 - 8	5 - 7	4	5 - 6
		LPM	9.5 - 9.8	10.6 - 11.4	16.7 - 19.7	26.5 - 30.3	45.4 - 53.0	114 - 125	144 - 167
	Low-Carbon Steel 1010, 1020, 1025, 1522, 1144, etc.	BAR	11 - 12	5 - 6	5 - 7	4 - 6	4 - 5	2 - 3	3 - 5
		LPM	9.1 - 9.5	9.1 - 9.8	14.0 - 15.9	22.7 - 26.5	41.6 - 45.4	98 - 114	125 - 144
	Medium-Carbon Steel 1030, 1040, 1050, 1527, 1140, 1151, etc.	BAR	11	5 - 6	5 - 6	4 - 5	3 - 5	2 - 3	3 - 5
		LPM	8.7 - 9.1	8.7 - 9.8	13.6 - 15.5	18.9 - 22.7	37.9 - 45.4	98 - 114	125 - 144
	Alloy Steel 4140, 5140, 8640, etc.	BAR	11	5	5 - 6	3 - 5	3 - 4	2	3
		LPM	8.7 - 9.1	8.3 - 9.1	13.2 - 14.8	18.9 - 22.7	31.9 - 41.6	98 - 106	114 - 125
	High-Strength Alloy 4340, 4330V, 300M, etc.	BAR	10 - 11	4	3	2	2	1 - 2	2
		LPM	8.7 - 9.1	7.9 - 8.3	11.0 - 11.7	15.1 - 18.9	26.5 - 30.3	79 - 87	87 - 98
	Structural Steel A36, A285, A516, etc.	BAR	11	5 - 6	5 - 6	3 - 4	3	2	3
		LPM	8.7 - 9.1	9.1 - 9.8	13.2 - 14.8	18.9 - 22.7	34.1 - 37.9	87 - 98	114 - 125
Tool Steel H-13, H-21, A-4, O-2, S-3, etc.	BAR	10 - 11	4	3	2	2	1 - 2	2	
	LPM	8.7 - 9.1	7.9 - 8.3	11.0 - 11.7	15.1 - 18.9	26.5 - 30.3	79 - 87	87 - 98	
S	High-Temp Alloy Hastelloy B, Inconel 600, etc.	BAR	10 - 11	4 - 5	3 - 4	2	2	2	3
		LPM	8.7 - 9.1	8.3 - 8.7	11.7 - 12.1	15.1 - 18.9	26.5 - 30.3	87 - 98	125
	Titanium Alloy	BAR	10 - 11	4 - 5	3 - 4	2	2	2	3
		LPM	8.7 - 9.1	8.3 - 8.7	11.7 - 12.1	15.1 - 18.9	26.5 - 30.3	87 - 98	125
Aerospace Alloy S82	BAR	10 - 11	4 - 5	3 - 4	2	2	2	3	
	LPM	8.7 - 9.1	8.3 - 8.7	11.7 - 12.1	15.1 - 18.9	26.5 - 30.3	87 - 98	125	
M	Stainless Steel 400 Series 416, 420, etc.	BAR	11.8	5.9	5.2	3.8	3.5	2	3.1
		LPM	9.5	9.8	14	23	38	98	117
	Stainless Steel 300 Series 304, 316, 17-4PH, etc.	BAR	11.8	5.9	5.2	3.8	3.5	2	3.1
		LPM	9.5	9.8	14	23	38	98	117
	Super Duplex Stainless Steel	BAR	11.8	5.9	5.2	3.8	3.5	2	3.1
		LPM	9.5	9.8	14	23	38	98	117
H	Wear Plate Hardox®, AR400, T-1, etc.	BAR	10.7	4.2	3.5	2	2	1.7	2
		LPM	9.1	8.3	11.7	19	30	87	98
	Hardened Steel	BAR	10.7	4.2	3.5	2	2	1.7	2
		LPM	9.1	8.3	11.7	19	30	87	98
K	SG / Nodular Cast Iron	BAR	11	4.5	4.2	2.8	2.4	2	2.4
		LPM	9.1	8.7	12.5	19	34	98	106
	Grey / White Iron	BAR	11	4.5	4.2	2.8	2.4	2	2.4
		LPM	9.1	8.7	12.5	19	34	98	106
N	Cast Aluminum	BAR	14.5	12.4	15.8	11	8.6	3.5	5.5
		LPM	10	14	23	34	61	125	159
	Wrought Aluminum	BAR	14.5	12.4	15.8	11	8.6	3.5	5.5
		LPM	10	14	23	34	61	125	159
	Aluminum Bronze	BAR	12.8	8.3	9.65	7.95	6.9	3.5	6.2
		LPM	9.6	11.4	19.7	30.3	53	125	167
	Brass	BAR	11	4.5	4.2	2.8	2.4	2	2.4
		LPM	9.1	8.7	12.5	19	34	98	106
	Copper	BAR	12.8	8.3	9.65	7.95	6.9	3.5	6.2
		LPM	9.6	11.4	19.7	30.3	53	125	167

#### Deep Hole Drilling Coolant Adjustment

	Holder Length				
	Extended	Long	Long Plus	XL	3XL
Pressure and Flow	1.3	1.5	2	2	3

#### Recommended Coolant Example

If the recommended pressure and flow is 12 bar and 22 LPM for a standard length holder, then the adjusted pressure and flow for a 3XL holder would be 36 bar and 66 LPM.

$$12 \cdot 3 = 36 \text{ bar} \quad 22 \cdot 3 = 66 \text{ LPM}$$

#### ⚠️ WARNING Tool failure can cause serious injury. To prevent:

- When using holders without support bushing, use a short T-A® holder to establish an initial hole that is a minimum of 2 diameters deep.
- Do not rotate tool holder more than 50 RPM unless it is engaged with the workpiece or fixture.

Visit [www.alliedmachine.com/DeepHoleGuidelines](http://www.alliedmachine.com/DeepHoleGuidelines) for the most up-to-date information and procedures. Factory technical assistance is available for your specific applications through our Application Engineering Team.

**IMPORTANT:** The coolant pressure and flow rate recommendations above represent a good approximation to obtain optimum tool life and chip evacuation at Allied Machine recommended speeds and feeds. If lower coolant capabilities exist in a drilling application, the T-A® drilling system will still function at reduced penetration rates. Contact our Application Engineering department for a more specific recommendation of coolant requirements and/or speeds and feeds.

## Coolant Recommendations | Metric (mm)

### Carbide Drill Inserts

ISO	Material	Pressure or Flow Rate	9.5 mm - 12.5 mm	13 mm - 17 mm	18 mm - 24 mm	25 mm - 35 mm	36 mm - 47 mm
P	Free-Machining Steel 1118, 1215, 12L14, etc.	BAR	17 - 20	17	15	15	20
		LPM	12.2	16.3	25.2	41.5	71.9
	Low-Carbon Steel 1010, 1020, 1025, 1522, 1144, etc.	BAR	18	11	11	12	9
		LPM	11.4	13.3	20.6	36.5	62.0
	Medium-Carbon Steel 1030, 1040, 1050, 1527, 1140, 1151, etc.	BAR	17	10	10	10	8
		LPM	11.3	12.5	20.0	33.8	57.0
	Alloy Steel 4140, 5140, 8640, etc.	BAR	17	9	10	8	7
		LPM	11.1	12.3	19.3	30.0	55.8
	High-Strength Alloy 4340, 4330V, 300M, etc.	BAR	15	5	4	3	3
		LPM	10.4	9.1	12.6	18.8	33.6
Structural Steel A36, A285, A516, etc.	BAR	16	9	8	7	5	
	LPM	10.8	12.0	17.5	27.8	47.1	
Tool Steel H-13, H-21, A-4, O-2, S-3, etc.	BAR	15	5	5	3	3	
	LPM	10.4	9.1	13.6	19.7	36.5	
S	High-Temp Alloy Hastelloy B, Inconel 600, etc.	BAR	17	11	12	11	9
		LPM	11.1	13.5	21.9	35.4	62.0
	Titanium Alloy	BAR	17	11	12	11	9
		LPM	11.1	13.5	21.9	35.4	62.0
Aerospace Alloy S82	BAR	17	11	12	11	9	
	LPM	11.1	13.5	21.9	35.4	62.0	
M	Stainless Steel 400 Series 416, 420, etc.	BAR	22.7	16.5	17.9	17.2	13.1
		LPM	13	16.3	26.3	44.2	75
	Stainless Steel 300 Series 304, 316, 17-4PH, etc.	BAR	22.7	16.5	17.9	17.2	13.1
		LPM	13	16.3	26.3	44.2	75
Super Duplex Stainless Steel	BAR	22.7	16.5	17.9	17.2	13.1	
	LPM	13	16.3	26.3	44.2	75	
H	Wear Plate Hardox®, AR400, T-1, etc.	BAR	14.5	5.2	4.8	3.4	3.1
		LPM	10.4	9.1	13.6	19.7	36.5
	Hardened Steel	BAR	14.5	5.2	4.8	3.4	3.1
		LPM	10.4	9.1	13.6	19.7	36.5
K	SG / Nodular Cast Iron	BAR	15.5	7.2	6.2	6.2	5.5
		LPM	10.7	10.8	15.4	26.5	48.7
	Grey / White Iron	BAR	15.5	7.2	6.2	6.2	5.5
		LPM	10.7	10.8	15.4	26.5	48.7
N	Cast Aluminum	BAR	24.1	22	21.7	19.6	13.8
		LPM	13.4	18.8	29	47.2	77
	Wrought Aluminum	BAR	24.1	22	21.7	19.6	13.8
		LPM	13.4	18.8	29	47.2	77
	Aluminum Bronze	BAR	20	16.5	16.5	15.2	12
		LPM	12.2	16.3	25.2	41.5	71.9
	Brass	BAR	24.1	22	21.7	19.6	13.8
		LPM	13.4	18.8	29	47.2	77
Copper	BAR	20	16.5	16.5	15.2	12	
	LPM	12.2	16.3	25.2	41.5	71.9	

#### Deep Hole Drilling Coolant Adjustment

	Holder Length				
	Extended	Long	Long Plus	XL	3XL
Pressure and Flow	1.3	1.5	2	2	3

#### Recommended Coolant Example

If the recommended pressure and flow is 12 bar and 22 LPM for a standard length holder, then the adjusted pressure and flow for a 3XL holder would be 36 bar and 66 LPM.

$$12 \cdot 3 = 36 \text{ bar}$$

$$22 \cdot 3 = 66 \text{ LPM}$$

#### ⚠ WARNING Tool failure can cause serious injury. To prevent:

- When using holders without support bushing, use a short T-A® holder to establish an initial hole that is a minimum of 2 diameters deep.
- Do not rotate tool holder more than 50 RPM unless it is engaged with the workpiece or fixture.

Visit [www.alliedmachine.com/DeepHoleGuidelines](http://www.alliedmachine.com/DeepHoleGuidelines) for the most up-to-date information and procedures. Factory technical assistance is available for your specific applications through our Application Engineering Team.

**IMPORTANT:** The coolant pressure and flow rate recommendations above represent a good approximation to obtain optimum tool life and chip evacuation at Allied Machine recommended speeds and feeds. If lower coolant capabilities exist in a drilling application, the T-A® drilling system will still function at reduced penetration rates. Contact our Application Engineering department for a more specific recommendation of coolant requirements and/or speeds and feeds.

## Troubleshooting Guide

	Potential Problem																					
	Accelerated corner wear	Barber pole	Bell-mouth hole	Insert chipping	Blue chips	Built-up Edge (BUE)	Chatter	Chip packing	Chipping of point	Damaged or broken tools	Excessive margin wear	High flank wear	Hole lead off	Hole out of position	Hole out of round	Notching of insert	Oversize hole	Poor hole finish	Poor tool life	Power spikes - Load meter	Step burned on insert	
<b>Setup Condition</b>	1	2	3	4	5	6	7	8	9	10	11	12	13	14	15	16	17	18	19	20	21	<b>Possible Solutions</b>
<p>⚠ Use of Standard, Standard Plus, Extended, Long, Long Plus, XL, and 3XL holders.</p> <p>See page 146 for Deep Hole Drilling guidelines.</p>		2	3				7		9				13	14			17					<ul style="list-style-type: none"> <li>Start with short holder and drill a minimum depth equal to 2xD (see page A30: 146 for instructions).</li> <li>Spot hole with stub tool of same or greater included angle as T-A® drill insert.</li> <li>Decrease feed a minimum of 50% until establishing full diameter.</li> <li>Use special holder with wear pads or chrome bearing area to work with drill bushings.</li> </ul>
Starting on an inclined surface.		2					7		9	10	11		13		15							<ul style="list-style-type: none"> <li>Spot face surface to provide a flat entry surface.</li> <li>Spot hole with stub tool of same or greater included angle as T-A® drill insert.</li> <li>Decrease feed a minimum of 50% until establishing full diameter.</li> <li>Use special holder with wear pads or chrome bearing area to work with drill bushings.</li> </ul>
Worn or misaligned spindle (lathe, screw machine, chucker).	1	2	3				7		9	10	11		13				17	18				<ul style="list-style-type: none"> <li>Align spindle and turret or tailstock.</li> <li>Repair spindle.</li> <li>Spot hole with stub tool of same or greater included angle as T-A® drill insert.</li> </ul>
Use of low rigidity machine tools (radial drills, multi-spindle drill press, etc.).		2	3	4			7		9	10			13	14								<ul style="list-style-type: none"> <li>Spot hole with stub tool of same or greater included angle as T-A® drill insert.</li> <li>Reduce penetration rate to fall within the physical limits of the machine or setup (<b>NOTICE:</b> Do not reduce feed below threshold of good chip formation).</li> <li>Use special holder with wear pads or chrome bearing area to work with drill bushings.</li> <li>Use tougher tool steel grades with high wear-resistant coatings.</li> </ul>
Poor work piece support.		2		4			7			10	11				15				18			<ul style="list-style-type: none"> <li>Provide additional support for the work piece. Reduce penetration rate to fall within the physical limits of the machine or setup (<b>NOTICE:</b> Do not reduce feed below threshold of good chip formation).</li> <li>Use tougher tool steel grades with high wear-resistant coatings.</li> </ul>
Flood coolant, low coolant pressure or low coolant volume.	1				5	6		8		10		12					17	18	19	20	21	<ul style="list-style-type: none"> <li>Run coolant through tool holder when drilling greater than one times diameter.</li> <li>Increase coolant pressure and volume through the tool holder.</li> <li>Reduce penetration rate to fall within the coolant limitations (<b>NOTICE:</b> Do not reduce feed below threshold of good chip formation).</li> <li>Add a peck cycle to help clear chips.</li> </ul>

**1. WARNING** Tool failure can cause serious injury. To prevent:

- When using holders without support bushing, use a short T-A® holder to establish an initial hole that is a minimum of 2 diameters deep.
- Do not rotate tool holder more than 50 RPM unless it is engaged with the workpiece or fixture.



Visit [www.alliedmachine.com/DeepHoleGuidelines](http://www.alliedmachine.com/DeepHoleGuidelines) for the most up-to-date information and procedures. Factory technical assistance is available for your specific applications through our Application Engineering Team.



	Potential Problem																					
	Accelerated corner wear	Barber pole	Bell-mouth hole	Insert chipping	Blue chips	Built-up Edge (BUE)	Chatter	Chip packing	Chipping of point	Damaged or broken tools	Excessive margin wear	High flank wear	Hole lead off	Hole out of position	Hole out of round	Notching of insert	Oversize hole	Poor hole finish	Poor tool life	Power spikes - Load meter	Step burned on insert	
Setup Condition	1	2	3	4	5	6	7	8	9	10	11	12	13	14	15	16	17	18	19	20	21	Possible Solutions
Interrupted cuts. Entry or exit surfaces that are not perpendicular to the spindle (draft angles, stepped surfaces, cross holes, and cast or forged surfaces).				4			7		9	10	11		13	14	15			17	18	19		<ul style="list-style-type: none"> <li>• Premill (spot face) entry or exit surface to remove interruption.</li> <li>• Spot hole with stub tool of same or greater included angle as T-A® drill insert.</li> <li>• Decrease feed as much as 50% through entry or exit interruption.</li> <li>• Use short holders in low impact entry cuts.</li> </ul>
Material harder than expected or running tools beyond recommended speeds.	1				5	6				10		12							19		21	<ul style="list-style-type: none"> <li>• Reduce speed if a step is worn in the insert, calculate SFM at the worn diameter. Reduce this value by 10% and apply this new value to the original tool diameter.</li> <li>• Increase coolant pressure and volume.</li> <li>• Improve coolant condition by use of quality products and regular maintenance.</li> <li>• Select an insert grade (premium, super cobalt, or carbide) or coating (TiAlN, TiCN, or AM200®) that is more wear-and heat-resistant.</li> </ul>
Poor material micro-structure or foreign particles (forgings and castings that have not been normalized or annealed, poorly prepared steel, flame cut parts and sand casting).				4		6				10		12	13				16			19		<ul style="list-style-type: none"> <li>• Compare performance of other tools for similar wear problems, which may indicate poor micro-structure. Anneal or normalize parts to improve micro-structure for machining.</li> <li>• To improve tool life in materials with poor micro-structure, try carbide grades.</li> <li>• For hard spots or inclusions, use the tougher insert steel grade with high wear-resistant coatings (TiAlN, TiCN, AM200®).</li> <li>• Reduce feeds (<b>NOTICE:</b> Do not reduce feed below threshold of good chip formation).</li> </ul>
Poor chip control.								8		10	11		13					17	18	19	20	<ul style="list-style-type: none"> <li>• Increase feed to recommended levels. Contact Allied's Application Engineering team for technical recommendations.</li> <li>• Increase coolant pressure and volume.</li> <li>• Improve coolant condition by use of quality products and regular maintenance.</li> <li>• See pages A30: 4 - 5 for special purpose geometries.</li> </ul>
Spot drilled holes with included angle less than that matching T-A® or cored holes.	1			4			7						13				16			19		<ul style="list-style-type: none"> <li>• Spot hole with short tool of same or greater included angle as T-A® drill insert.</li> <li>• Reduce feed (<b>NOTICE:</b> Do not reduce feed below threshold of good chip formation)</li> <li>• If possible, drill from solid.</li> </ul>
Use of high wear-resistant insert grades.				4						10												<ul style="list-style-type: none"> <li>• Use tougher grade of T-A® (from carbide to cobalt to HSS). See wear versus toughness chart on page A30: 9.</li> <li>• Increase rigidity of setup.</li> </ul>

## Deep Hole Drilling Guidelines

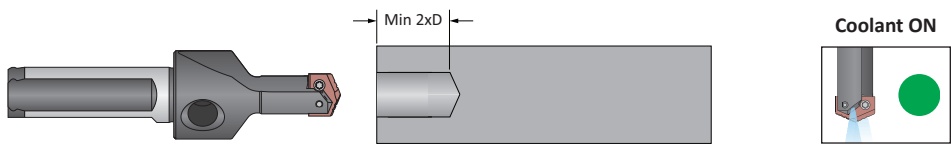
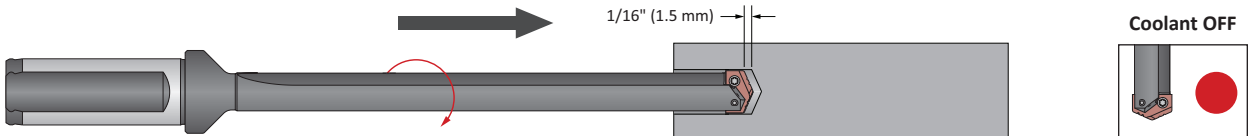
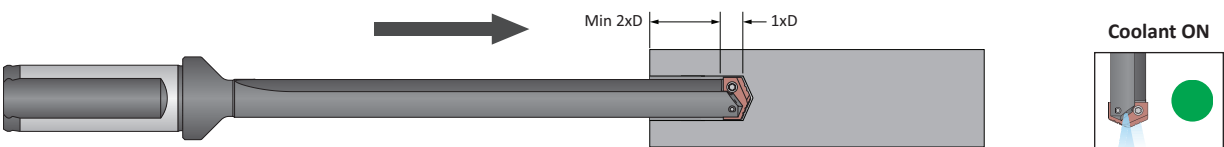
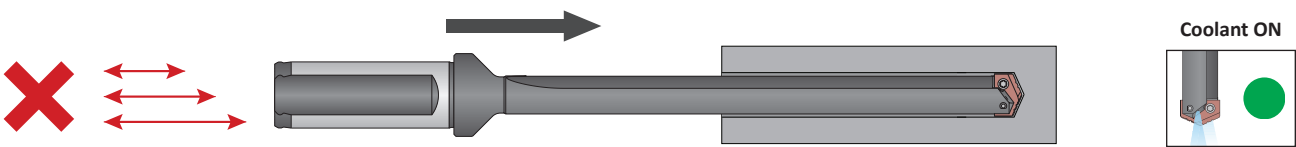
For Lengths Greater Than 9xD (including Standard Plus, Extended Length, Long Length, Long Plus Length, XL, 3XL, and Special Length)

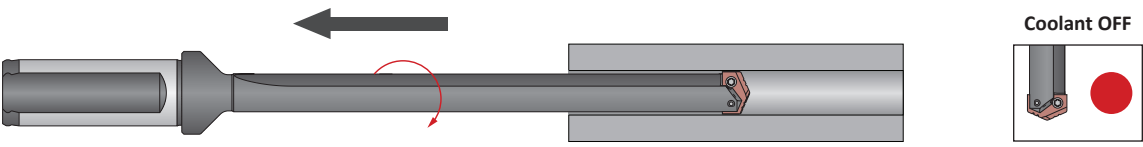
A DRILLING	<p><b>1. Pilot Hole</b> 100 % RPM 100% IPR (mm/rev)</p>	<p>Establish the pilot hole using the same diameter short drill to a depth of 2xD minimum. Utilize a pilot drill with the same or larger included point angle.</p>	
B BORING	<p><b>2. Feed-in</b> 50 RPM max 12 IPM (300 mm/min)</p>	<p>Feed the longer drill within 1/16" (1.5 mm) short of the established pilot hole bottom at a <b>maximum of 50 RPM</b> and 12 IPM (300 mm/min) feed rate.</p>	
C REAMING	<p><b>3. Deep Hole Transition Drilling</b> 50 % RPM 75% IPR (mm/rev)</p>	<p>Drill additional 1xD past the bottom of the pilot hole at 50% reduction of recommended speed and 25% reduction of recommended feed. Minimum of 1 second dwell is required to meet full speed before feeding.</p>	
D BURNISHING	<p><b>4. Deep Hole Drilling - Blind</b> 100% RPM 100% IPR (mm/rev)</p>	<p>Drill to full depth at recommended speed and feed for longer drill according to Allied speed and feed charts. <b>No peck cycle recommended.</b></p>	
E THREADING	<p><b>5. Deep Hole Drilling - at Breakout</b> 50% RPM 75% IPR (mm/rev)</p>	<p><b>For through holes only:</b> Reduce speed by 50% and feed by 25% prior to breakout. Do not breakout more than 1/8" (3 mm) past the full diameter of the drill.</p>	
X SPECIALS	<p><b>6. Drill Retract</b> 50 RPM max</p>	<p>Reduce speed to a <b>maximum of 50 RPM</b> before retracting from the hole.</p>	

**1. WARNING** Tool failure can cause serious injury. To prevent:

- When using holders without support bushing, use a short T-A® holder to establish an initial hole that is a minimum of 2 diameters deep.
- Do not rotate tool holder more than 50 RPM unless it is engaged with the workpiece or fixture.

Visit [www.alliedmachine.com/DeepHoleGuidelines](http://www.alliedmachine.com/DeepHoleGuidelines) for the most up-to-date information and procedures. Factory technical assistance is available for your specific applications through our Application Engineering Team.



## Interactive Experience

Visit our digital platform.

- Explore various locations and zones to see real people in real positions
- See our training and engineering departments
- Get a glimpse of our state-of-the-art logistical and machining equipment
- Virtually meet our customer service and marketing teams
- Access digital resources like literature, videos, and online tools and training



[experience.alliedmachine.com](http://experience.alliedmachine.com)



# ToolMD<sup>®</sup>

Increase the production and success of your applications today.

- Direct access to 2D drawings and 3D models
- Assemble and view tool images in your browser
- Download drawings for use in most machining software programs
- Browse products, search item numbers, and save assemblies for future use

[toolmd.com](http://toolmd.com)

## WOHLHAUPTER<sup>®</sup>

### Boring Insert Selector

Find the best insert for your application.

- Generate the correct boring insert for your job in just six easy steps
- Choose type, shape, substrate, insert form, nose radius, and material
- Order easily by adding the item to your cart

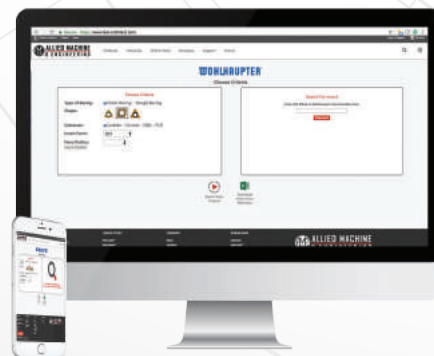
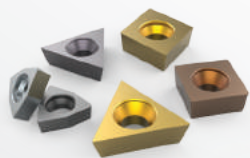

[alliedmachine.com/bis](http://alliedmachine.com/bis)

# Insta-Code®

**Eliminate the wait. Get your program now.**

- Choose the best thread mill for your application
- Create program code for your machine
- Available as a PC download app (that can be used offline)
- Website app available 24/7



Insta-Code also has a  
**Cycle Time Calculator**

[alliedmachine.com/InstaCode](http://alliedmachine.com/InstaCode)

# Insta-Quote®

**Design your custom tooling and receive a drawing and quote...all within minutes.**

- Design and quote your own tooling
- Generate the solution you need in just a few steps
- Features the following products:
  - T-A® Inserts
  - T-A® Holders
  - GEN3SYS® XT Holders
  - ALVAN® Reamers

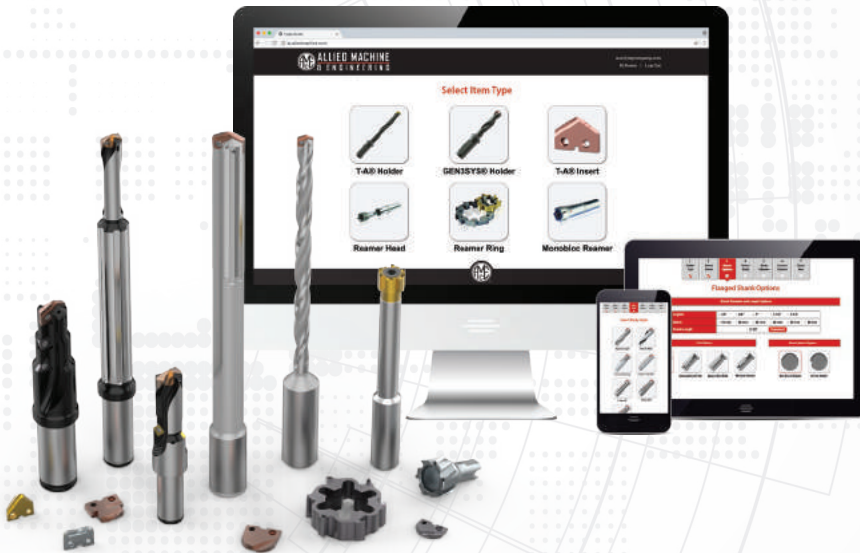

[iq.alliedmachine.com](http://iq.alliedmachine.com)

## Solution Hub App

**All Allied all the time.**

- Quickly look up product information
- Links to our free online tools
- Locate distributors
- Stay up to date on news and events



## Machinist Tool App

**Quickly convert cutting tool parameters for the machine inputs you need.**

- Input data to calculate the RPM and speed and feed rates
- Also features the Boring Insert Selector
- Access product literature right at your fingertips

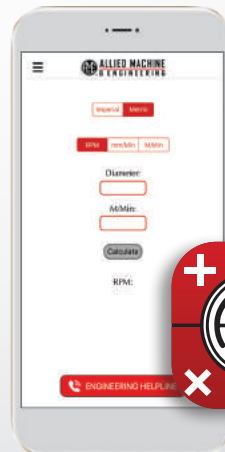

## Customer Support

### Support You Can Count On

Allied Machine has many lines of support to ensure we're available to assist you at all times. It's important to establish relationships with new customers, but we also know it's equally important to strengthen and support relationships with existing customers. Whether you need help with an order or you need someone to come assist you at the spindle, we have the right people to get you what you need.



1

#### Inside Sales Support

Our inside sales team is trained to handle your account information and general inquiries. We are happy to assist you and find the answers to your questions.

- ☎ 1.330.343.4283 ext. 8610
- ☎ 1.800.321.5537 (toll free United States and Canada)
- ✉ [insidesales@alliedmachine.com](mailto:insidesales@alliedmachine.com)

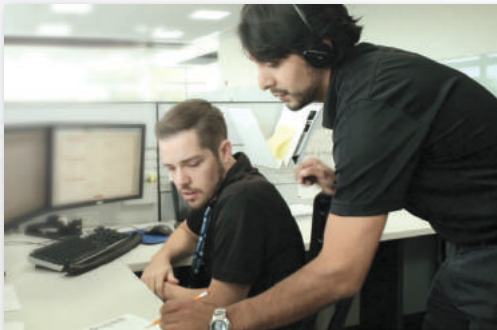

2

#### Engineering Support

Our highly trained and skilled Application Engineers are here to assist you. If you are experiencing technical difficulties, our engineers will recommend the best solutions to the problem. Speeds and feeds, coolant pressure, and other machining components all affect the performance of our tooling. Our AEs are experienced in working with difficult materials in many different environments. Give us a call and put our knowledge to the test.

- ☎ 1.330.343.4283 ext. 7611
- ☎ 1.800.321.5537 (toll free United States and Canada)
- ✉ [appeng@alliedmachine.com](mailto:appeng@alliedmachine.com)

3

#### Field Support

Allied Machine provides local engineering support all over the world. Our Field Sales Engineers (FSEs) spend months training in-house before going to the field. This support line allows us to provide assistance to our customers right at the spindle. They are available to visit your facility, run demos and tests, and work hand-in-hand with machine operators and engineers to find the best possible tooling solutions.

Visit [www.alliedmachine.com/fse](http://www.alliedmachine.com/fse) to get in touch with your local Field Sales Engineer.

- ☎ 1.330.343.4283
- ☎ 1.800.321.5537 (toll free United States and Canada)
- ✉ [info@alliedmachine.com](mailto:info@alliedmachine.com)





# Allied Tool Academy

Online | On-site Technical Education Seminar (TES) | LIVE (Broadcasting)

## Online Training

Get **all** the tooling training of our 3-day in-person Technical Education Seminar (TES) through the online **Allied Tool Academy** training platform. Level up your tooling IQ through a series of product overviews, demos, and short quizzes.

- Online TES Certification as well as other training modules
- On demand
- On YOUR schedule

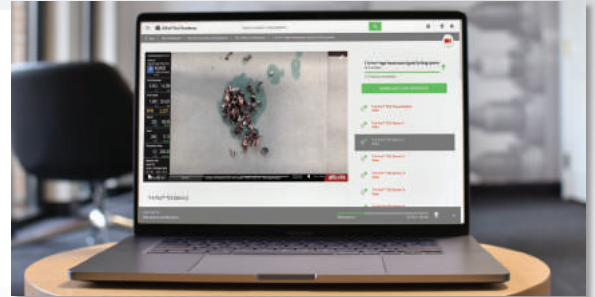

Register online today:  
[www.alliedtoolacademy.com](http://www.alliedtoolacademy.com)



## Allied LIVE (Broadcasting)

Join us for **LIVE broadcast** training events where you will have the ability to learn about our tooling, watch live demos, and ask our trainers questions.

- Online
- Quick brief presentation provides basic knowledge of our products
- Watch live demos of tools at the spindle at different speeds and feeds

Register online today:  
[www.alliedmachine.com/live](http://www.alliedmachine.com/live)

## On-site Technical Education Seminar (TES)

Allied Machine's **Technical Education Seminar (TES)** puts the attendees in front of the machines. When you attend our three day TES program, you'll gain first-hand experience in **real-life** application situations. Test and experiment with different speeds and feeds, observe the results, and discover the best solution.

- Training Lab: In-depth training at the spindle allows you to choose speeds and feeds
- Learning Lab: Quick, brief sessions provide basic knowledge of our products
- Facility Tours: Take guided tours of our two manufacturing facilities located in Dover, Ohio



 Register online today:  
[www.alliedmachine.com/TES](http://www.alliedmachine.com/TES)



**Allied Machine Training Facility**  
485 West 3rd Street  
Dover, OH 44622

# Guaranteed Test / Demo Application Form

Distributor PO # \_\_\_\_\_

The following must be filled out completely before your test will be considered

## Distributor Information

Company Name: \_\_\_\_\_  
 Contact: \_\_\_\_\_  
 Account Number: \_\_\_\_\_  
 Phone: \_\_\_\_\_  
 Email: \_\_\_\_\_

## End User Information

Company Name: \_\_\_\_\_  
 Contact: \_\_\_\_\_  
 Industry: \_\_\_\_\_  
 Phone: \_\_\_\_\_  
 Email: \_\_\_\_\_

**Current Process** List all tooling, coatings, substrates, speeds and feeds, tool life, and any problems you are experiencing

**Test Objective** List what would make this a successful test (i.e. penetration rate, finish, tool life, hole size, etc.)

## Application Information

Hole Diameter: _____ in/mm	Tolerance: _____	Material: _____ (4150 / A36 / Cast Iron / etc.)
Preexisting Diameter: _____ in/mm	Depth of Cut: _____ in/mm	Hardness: _____ (BHN / Rc)
Required Finish: _____ RMS	State: _____	(Casting / Hot rolled / Forging)

## Machine Information

Machine Type: _____ (Lathe / Screw machine / Machine center / etc.)	Builder: _____ (Haas, Mori Seiki, etc.)	Model #: _____
Shank Required: _____ (CAT50 / Morse taper, etc.)		Power: _____ HP/KW
Rigidity: _____	Orientation: _____	Tool Rotating: _____
<input type="checkbox"/> Excellent	<input type="checkbox"/> Vertical	<input type="checkbox"/> Yes
<input type="checkbox"/> Good	<input type="checkbox"/> Horizontal	<input type="checkbox"/> No
<input type="checkbox"/> Poor		Thrust: _____ lbs/N

## Coolant Information

Coolant Delivery: _____ (Through tool / Flood)	Coolant Pressure: _____ PSI / bar
Coolant Type: _____ (Air mist, oil, synthetic, water soluble, etc.)	Coolant Volume: _____ GPM / LPM

## Requested Tooling

QTY	Item Number

QTY	Item Number



**Allied Machine & Engineering**  
 120 Deeds Drive  
 Dover, OH 44622

Telephone: (330) 343-4283  
 Toll Free USA & Canada: (800) 321-5537  
 Fax: (330) 602-3400



## Warranty Information



Allied Machine & Engineering ("Allied Machine") warrants to original equipment manufacturers, distributors, industrial and commercial users of its products for one year from the original date of sale that each new product manufactured or supplied by Allied Machine shall be free from defects in material and workmanship.

Allied Machine's sole and exclusive obligation under this warranty is limited to, at its option, without additional charge, replacing or repairing this product or issuing a credit. For this warranty to be applied, the product must be returned freight prepaid to the plant designated by an Allied Machine representative and which, upon inspection, is determined by Allied Machine to be defective in material and workmanship.

Complete information as to operating conditions, machine, setup, and the application of cutting fluid should accompany any product returned for inspection. This warranty shall not apply to any Allied Machine products which have been subjected to misuse, abuse, improper operating conditions, improper machine setup or improper application of cutting fluid or which have been repaired or altered if such repair or alteration, in the judgement of Allied Machine, would adversely affect the performance of the product.

THIS WARRANTY IS IN LIEU OF ALL OTHER WARRANTIES, EXPRESS OR IMPLIED, INCLUDING ANY IMPLIED WARRANTY OF MERCHANTABILITY OR FITNESS FOR A PARTICULAR PURPOSE. Allied Machine shall have no liability or responsibility for any claim, whether in contract, tort or otherwise, for any loss or damage arising out of, connected with, or resulting from the manufacture, sale, delivery or use of any product sold hereunder, in excess of the cost of replacement or repair as provided herein.

Allied Machine shall not be liable in contract or in tort (including, without limitation, negligence, strict liability or otherwise) for economic losses of any kind or for any special, incidental, indirect, consequential, punitive or exemplary damages arising in any way out of the performance of, or failure to perform this agreement.

ALL PRICES, DELIVERIES, DESIGNS, AND MATERIALS ARE SUBJECT TO CHANGE WITHOUT NOTICE.



Allied Machine & Engineering  
is registered to  
ISO 9001:2015 by DQS

## United States

### Allied Machine & Engineering

120 Deeds Drive  
Dover OH 44622  
United States

**Phone:**  
+1.330.343.4283

**Fax:**  
+1.330.602.3400

**Toll Free USA and Canada:**  
800.321.5537

**Toll Free USA and Canada:**  
800.223.5140

### Allied Machine & Engineering

485 W Third Street  
Dover OH 44622  
United States

**Phone:**  
+1.330.343.4283

**Fax:**  
+1.330.364.7666  
(Engineering Dept.)

**Toll Free USA and Canada:**  
800.321.5537

## Europe

### Allied Machine & Engineering Co. (Europe) Ltd.

93 Vantage Point  
Pensnett Estate  
Kingswinford  
West Midlands  
DY6 7FR England

**Phone:**  
+44 (0) 1384.400900

### Wohlhaupter GmbH

Maybachstrasse 4  
Postfach 1264  
72636 Frickenhausen  
Germany

**Phone:**  
+49 (0) 7022.408.0

**Fax:**  
+49 (0) 7022.408.212

## Asia

### Wohlhaupter India Pvt. Ltd.

B-23, 3rd Floor  
B Block Community Centre  
Janakpuri, New Delhi - 110058  
India

**Phone:**  
+91 (0) 11.41827044

Your local Allied Machine representative:

[www.alliedmachine.com](http://www.alliedmachine.com)

Allied Machine & Engineering is registered to ISO 9001:2015 by DQS



Copyright © 2022 Allied Machine & Engineering Corp. All rights reserved.  
All trademarks designated with the ® symbol are registered in the United States and other countries.  
Available Online Only  
Publish Date: August 2022